

**Timber
as a construction material
in humanitarian operations**

The designations employed and the presentation of the material in this publication do not imply the expression of any opinion whatsoever on the part of the Secretariat of the United Nations concerning the legal status of any country, territory, city or area, or its authorities, or concerning the delimitation of its frontiers or boundaries.

The opinions, figures and estimations set forth in this document are the responsibility of the authors, and should not necessarily be considered as reflecting the views or carrying the endorsement of the United Nations, IFRC and CARE International.

Material in this publication may be freely quoted or reprinted, but acknowledgement is requested, together with a reference to the document number. A copy of the publication containing the quotation or reprint should be sent to OCHA (lsu@un.org).

This book is copyright © 2009 by the United Nations, the Office for the Coordination of Humanitarian Affairs (OCHA), the International Federation of Red Cross and Red Crescent Societies (IFRC) and CARE International.

Foreword

In most emergency and reconstruction projects timber and bamboo are used as construction materials. As they are natural materials, they have unique properties and require special environmental, supply, logistics and construction considerations. Often humanitarian organisations are not aware of all of these considerations and mistakes are frequently made, leading to delays in response, costing extra money to put right and putting people's safety at risk.

This book is a response to organisations' and practitioners' need for guidance in complicated local and global contexts, as well as providing the timber industry with some understanding of the kind of issues the humanitarian community is dealing with.

As part of their organisational commitments to encourage more effective and coordinated humanitarian aid, the United Nations Office for the Coordination of Humanitarian Affairs (OCHA), the International Federation of Red Cross and Red Crescent Societies (IFRC), and CARE International have collaborated on the production and distribution of "Timber as a construction material in humanitarian operations".

The book is based on a scoping study published by OCHA in May 2007. Subsequent drafts were discussed at peer reviews in Indonesia, Kenya, the UK and the USA. The final version is the result of inputs from more than 100 people from a wide range of organisations. IFRC, OCHA and CARE International are extremely grateful for their contributions.

Given the diversity of local building practices and cultures, this book is not intended to be a definitive how-to building guide for using timber as a construction material. Instead it highlights key issues to be considered by teams of program, technical and logistical staff when making decisions in construction projects involving timber or bamboo. It also provides some basic construction and specification information for times when expert help is hard to find.

Isabelle de Muysier-Boucher
Chief, Logistics Support Unit
OCHA

Graham Saunders
Head Shelter Department
IFRC

Elizabeth Babister
Emergency Shelter and Reconstruction Senior Specialist
CARE International

Acknowledgments

This book was compiled, illustrated and written by Joseph Ashmore and Jon Fowler.

The project was managed by Isabelle de Muysen-Boucher at OCHA, Graham Saunders at IFRC and Elizabeth Babister at CARE International.

Project consultants and key contributors: Bill Flinn, Dave Hodgkin, Gordon Browne, David Stone, Naomi Bowman, Pascal Kandem.

Comments and contributions: Adrian Porter, Alan Early, Anita van Breda, Antonella Vitale, Arian Ardie, Arshad Aziz, Barry Hearse, Bruno Dercon, Carsten Voelz, Charles Kelly, Charles Setchell, Chris Nixon, Colin MacKenzie, Corinne Treherne, Dan Lewis, Dyfed Aubrey, Ed Pepke, Elin Holmén, Erin Patrick, Florence Secula, George Kuru, Gerret Springer, Goran Stojanovski, Goran Tannerfeldt, Gordon Browne, Harry Greaves, Helen Rowe, Ian Pearce, Ilan Kelman, Ingemar Sävfors, Jane Katz, Jean McCluskey, Jennifer Swan, Jeremy Broadhead, Jo Da Silva, John Kirkby, Jonathan Randall, Julia Macro, Julian Carter, Kazuko Puff, Kelly Wooster, Kenneth Sato, Kristof Bevernage, Lili Mohiddin, Linda Poteat, Lionel Jayanetti, Loren Lockwood, Loren Pinski, Maggie Stephenson, Manoucher Lolachi, Mark Wooding, Mary Melnyk, Matti Kuitinen, Megan Liddle, Michael Annear, Michael Benfield, Michael Kwaku, Miguel Urquia, Nabil Makki, Naomi Bourne, Neil Noble, Nick Willson, Nicole Laurent, Niklas Hagelberg, Olivier Siegenthaler, Øyvind Nordlie, Pat Naidoo, Paul Morris, Peter Manfield, Rachel Roseberry, Ralph Ashton, Ralph Douglass, Raphael Moras de Vasconcellos, Regan Potangaroa, Richard Haigh, Rick Bauer, Sarbjit Singh Sahota, Sebastian Fesneau, Simon Armstrong, Stepi Hakim, Steve Taylor, Tim Foster, Tim Nolan, Toby Gould, Tom Bamforth, Tom Corsellis, Tom Schacher, Tony Eastwood, Valentine Ndibalema, Veronica Taylor, Vicki Wooding.

Thanks to:

- Norwegian Refugee Council for the use of its internal timber procurement and specifications guidelines as the starting point for this book.
- The staff at Care International, IFRC, InterAction, Habitat for Humanity (Kenya and USA) and United States Agency for International Development (USAID) for hosting of peer reviews and workshops which were held in UK, Indonesia, Kenya, USA and Bangladesh.
- Oxfam GB Prime Project for technical inputs on Bamboo (see www.humanitarianbamboo.org).

Contents

Introduction

Foreword	iii
Acknowledgments	iv
Contents	v
i.1 Introduction	vii
i.2 Timber principles	viii
i.3 What is special about timber and bamboo?	ix
i.3 Types of timber and bamboo	x

A - Planning

A.1 Think before you build	3
A.2 Environment and protection	5
A.3 Legal issues	6
A.4 Markets and supply	7
A.5 Timber and other materials	10
A.6 Who will build and maintain?	12
A.7 Working as a team	13
A.8 Design	14
A.9 Checklists	16

B - Specification

B.1 Developing a specification	21
B.2 Source verification	23
B.3 Salvaging and harvesting	28
B.4 Durability	30
B.5 Drying timber	32
B.6 Treatments	34
B.7 Quality	40
B.8 Quantity	46
B.9 Delivery and payment	48
B.10 Specifications	49

C - Logistics

C.1	Planning logistics	53
C.2	Reception	54
C.3	Storage	55
C.4	Transport	57
C.5	Distribution	58
C.6	Health and Safety	59

D - Construction

D.1	Terminology	63
D.2	Foundations, walls and roof	65
D.3	Connections	70
D.4	Termites, pests and rot	75
D.5	Unseasoned timber and coconut	76
D.6	Poor quality timber	77
D.7	Construction checklist	78

Annexes

ii.1	Glossary	80
ii.2	Further references	86

i.1 Introduction

i.1.1 About this book

This book provides information on selecting, specifying, procuring, using, and distributing timber and bamboo as construction materials for small and medium-sized buildings in humanitarian operations.

It is aimed at program managers, logisticians, engineers and others working in humanitarian programs involving construction.

Basic construction advice is provided which is intended to help program staff when monitoring projects, but this is not a substitute for advice from technical professionals. The book should not be used as a construction manual.

This book is intended to complement international standards, such as Sphere; national building regulations; and organisations' own procurement policies. Information in this book must be adjusted to particular local contexts.

'Timber' is used in this book to mean:

- Sawn wood
- Timber poles
- Timber composites (e.g. plywood)
- Coconut timber (including wood from other palm tree species)

Bamboo has different properties to timber and is dealt with separately where appropriate.

Resources providing more detailed information on topics covered in this book are listed at the end of the book [[ii.2 Further references](#)].

Attention! Implementing construction projects that are not part of a wider strategic plan can result in serious negative consequences. See [[A - Planning](#)] for more advice on the planning stages of construction projects.

I could use this book to help with a project to build simple structures using plastic sheeting as covering.

We could use it for large scale procurements of timber for this school building programme.



i.2 Timber principles

These principles can be used as discussion points for establishing a common procurement or construction plan.

Five principles for constructing with timber

1) *Think before you build:*

All construction projects must be part of a strategy which takes into account social, economic and political factors such as patterns of settlement; land ownership; maintenance costs and responsibilities; laws and regulations; the host community; timeframes; and environmental issues. *[A - Planning]*

We need a strategy!

2) *Choose appropriate materials:*

Compare the environmental, economic, technical and social issues of using timber with other construction materials. Select materials that can be supplied without compromising resource sustainability. *[A - Planning]*.

Is this the best material for the job?

3) *Design and build safely and appropriately*

Design and build for safety. Follow local and national building regulations with relevant technical advice. Consider efficient timber construction methods, re-usability of timber components, and adaptation of the building by those using it. It should be possible to repair and upgrade constructions using locally available skills and materials.

*Is this safe?
We need a structural engineer!*

Design to preserve timber by the best method – keeping it dry. Ensure all fixings and treatments are safe.

In emergencies, follow Sphere standards guidance notes and indicators. *[Sections A, B, C and D]*

4) *Recycle wherever possible*

Investigate all possible sources, including salvaged timber. Such timber must be checked for structural safety and for ownership. *[A - Planning]*.

We can re-use this wood.

5) *Source legally, and ideally sustainably*

Do not purchase illegal timber. In the absence of reliable verification systems, humanitarian agencies should demonstrate due diligence in attempting to ensure timber is from a well-managed source. *[B - Specification]*.

*Is this timber certified?
Is it legal?*

When sourcing timber locally, use appropriate resource management principles.

i.3 What is special about timber and bamboo?

Strong and flexible

Timber is light-weight and strong: A timber beam will be stronger than a beam made of either concrete or steel of the same weight. Timber's flexibility makes it a good material to use in earthquake zones.

A common and familiar building material

Timber is used in buildings all over the world as it is usually affordable and requires building skills and tools available locally. This means that timber buildings are easily maintained and adapted by the people that use them.

Environmentally sustainable and recyclable

Timber and bamboo sourced from well managed forests and plantations are sustainable, renewable resources. Timber buildings can be dismantled and reused.

However, in some countries forestry is uncontrolled and substantial environmental damage is caused by badly managed or illegal logging. Identifying legal and sustainable timber can be difficult.

Timber buildings can last a long time

Timber and bamboo can last for many years and can be used in permanent housing. Using timber correctly can reduce risk of attack by fungus and insects.

Timber is a natural material

As timber and bamboo come from trees and plants their properties of density, weight, strength, flexibility, hardness and durability vary depending on both the species and which part of the plant or tree they are cut from. Identifying the right species of tree is an important part of specification.

Timber and bamboo can be beautiful! 😊

i.3 Types of timber and bamboo

Sawn timber

Sawn timber is commonly procured in standard sizes. Some basic sawn-timber terms are shown in the diagram below:

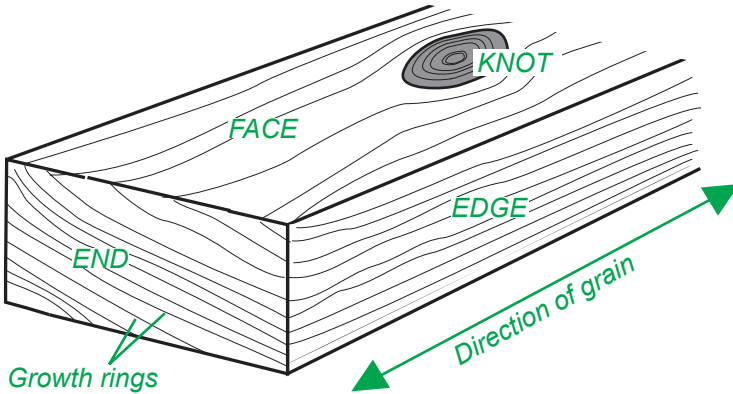

Sawn wood can be industrially graded, which helps to select the right timber for the right job. It can also be seasoned (dried) or treated to increase its durability [*B - Specification*]. In humanitarian emergencies (and in some architectural traditions) structures may be constructed using ungraded, unseasoned and untreated timber, often called 'green timber' [*D.5 Unseasoned timber and coconut*].

Poles

Poles are often used in simple constructions built by non-professionals, though they are increasingly used in technically complex buildings. [*Ref 8.8 Timber Pole Construction*]

Poles can be very strong, employing the natural structural strength of the tree itself.

Poles can be cut from younger trees than those used for sawn wood and can be a by-product of thinning larger trees. They are often cheaper as there are fewer processing costs. Removing bark from poles (debarking, peeling or rounding) may be required by importing authorities.

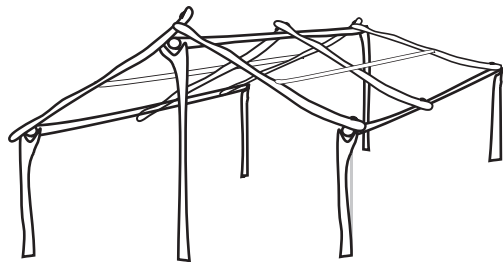

Simple structure using different shapes of poles

Timber composites

Timber composites include plywood medium density fibreboard (MDF), oriented strand board (OSB) and hardboard. They are made up of layers of timber or timber chips glued together.

Often used for walls and floors, they provide lightweight strength at relatively low cost. They are also used in concrete formwork and for decorative purposes.

Durability and resistance against decay and pests is determined by the adhesives and resins used in the production process.

Palm (coconut) timber

Palm trees do not produce growth rings as other trees do, and the timber is softer in the centre. As well as the trunk being used for structural purposes, leaves can be used for thatching. Palm timber is a resource that is often overlooked.

[[Ref 7.5 Coconut Palm Stem Processing Technical Handbook](#)].

Bamboo

Bamboo is the stem of a fast-growing grass, reproducing through its roots. The high speed of its re-growth is attracting more interest in its use as a construction material.

[[Ref 8.10 Building with Bamboo](#)], [[Ref 7.1 www.humanitarianbamboo.org](#)]

There are about 1,200 different botanical species of bamboo, with over 250 varieties suitable for construction. Each has different properties, so local knowledge is essential in specification.

Some species grow in patches (clump type) and others spread over a wide area (running type). A bamboo culm (the stem of the grass) can be between 2.5 and 30m long. Commercial sizes are commonly available at between 4m and 6m. Although solid species do exist, bamboo normally gets thinner at the top and is made up of hollow cavities separated by nodes.

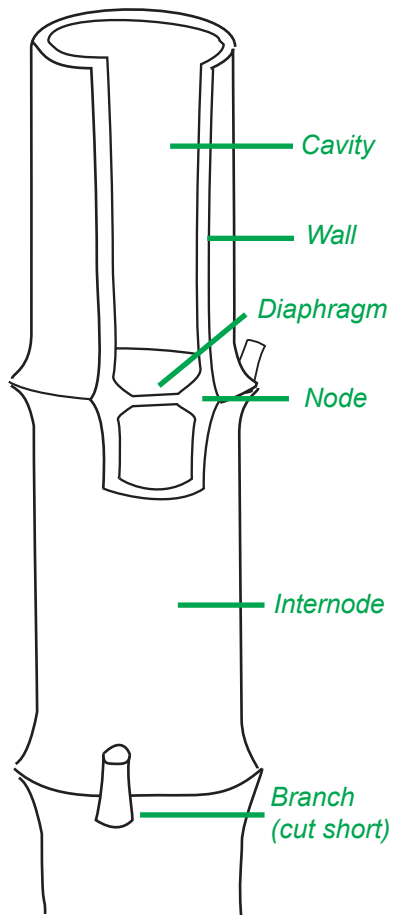

A - Planning

A.1	Think before you build	3
A.1.1	Develop a plan!	3
A.1.2	Assessment	4
A.2	Environment and protection	5
A.2.1	Environment	5
A.2.2	Protection	5
A.3	Legal issues	6
A.4	Markets and supply	7
A.4.1	Market analysis	7
A.4.2	Salvaged or recycled timber	8
A.4.3	Local markets, forests and plantations	8
A.4.4	National or international supply	9
A.5	Timber and other materials	10
A.5.1	Timber or bamboo?	10
A.5.2	Substitute materials	10
A.6	Who will build and maintain?	12
A.7	Working as a team	13
A.8	Design	14
A.8.1	Designing a structure	14
A.8.2	Efficient timber use	15
A.8.3	Fire safety	15
A.9	Checklists	16
A.9.1	Think before you build	16
A.9.2	Environment and protection	16
A.9.3	Legal issues	16
A.9.4	Markets and supply	16
A.9.5	Timber and other materials	16
A.9.6	Who will build and maintain?	16
A.9.7	Design checklist	17

B - Specification

C - Logistics

D - Construction

A.1 Think before you build

A.1.1 Develop a plan!

Timber and bamboo are versatile construction materials frequently used in emergency, temporary, and permanent construction. They are often sourced and used directly by those affected.

Any assistance involving construction should be part of a wider, coordinated plan. For more information on strategic and project planning, especially with regard to shelter, see [Ref 2 Strategic planning and assessment](#).

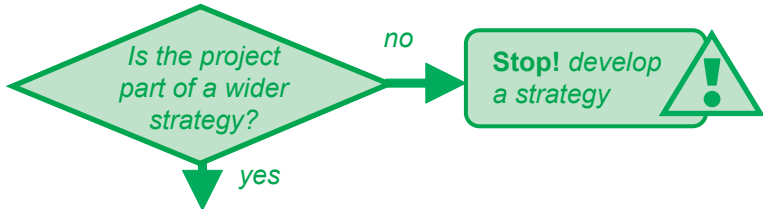

Form a plan and then implement it.

The plan may need to be adapted following ongoing assessments and consultation.

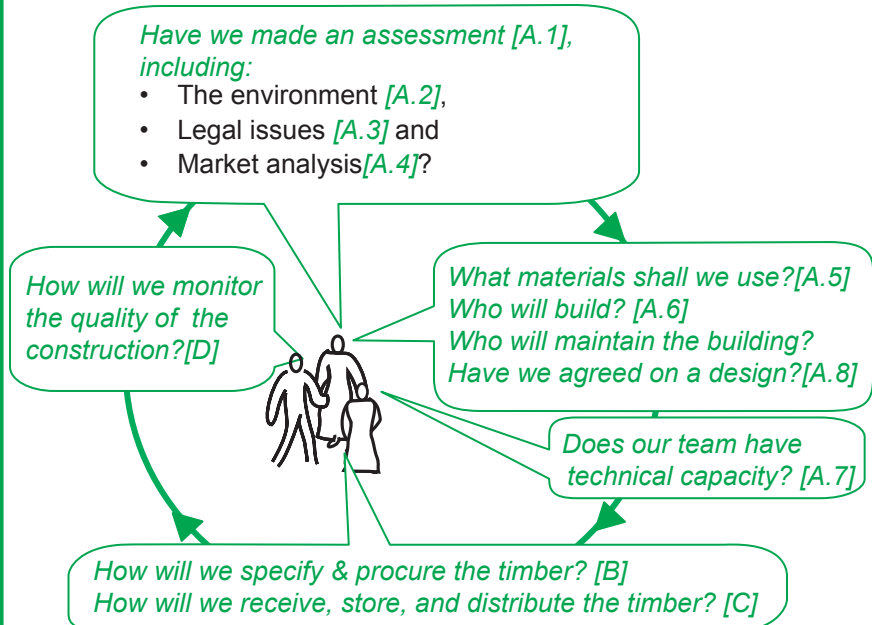

Remember to evaluate the project and share your findings!

A.1.2 Assessment

For assessment tools see  [Ref 2 Strategic planning and assessment](#).

Need

Be clear about what type of construction assistance is required before using timber or bamboo. Coordinated needs and damage assessments will identify what can be repaired, what needs to be built and where it needs to be sited.



*What do people already have? What do they need?
Is there a broader strategy?
Is this really the best location?
Who will be responsible for the maintenance costs?
Are there old buildings that can be repaired?*

We must discuss these issues with those affected by the crisis, including those who might normally be excluded.

Site

See [\[D.2.1 The site\]](#) for the wider issues around site selection. Timber and bamboo can deteriorate through rotting or insect attack so assess sites for such risks (e.g. flooding, presence of termites). Such risks will determine how structures should be built and whether treatments may be needed.

Duration of response

Consider how long the building is intended to last. The type of timber or bamboo, whether it needs to be dried or treated, and details of design will effect its durability.

Be aware that temporary structures are nearly always used for a longer time than intended. Building use changes over time and timber's reusability enables well-planned emergency assistance to be adapted to something more durable later.

For how many years is this clinic going to be here?

Will it have the same use after the emergency?



Timber and bamboo structures can decay if not properly looked after so every construction project needs a maintenance plan.

Lead times for importing timber can be considerable. Forward planning will help ensure large deliveries of timber arrive in time for the early reconstruction.



*I can use **other materials** until the timber arrives.
I can buy **some local timber** to get started while I am waiting for a large international delivery.
I will tell beneficiaries that the timber takes time to arrive.*

A.2 Environment and protection

A.2.1 Environment

For large programs an Environmental Impact Assessment should be made in coordination with other organisations to develop an environmental strategy for timber procurement.  [Ref 3.3 Guidelines for Rapid Environmental Assessment in Emergencies](#)

I live near a fragile forest and have been given a plastic sheet. I need some poles to hold up my roof.

Deforestation occurs when timber is sourced from unmanaged forests or when high demand for timber in an emergency leads to uncontrolled felling of trees near to settlements. To avoid this, you should consider the following:

- ✓ Do not distribute emergency materials such as plastic sheeting without considering what will be used for shelter structures.
- ✓ Have an agreed environmental strategy in place which involves communities.
- ✓ Conduct a rapid environmental assessment of the anticipated needs of construction materials (and fuelwood) and availability.
- ✓ Identify possible zones from where materials might be sourced.
- ✓ Develop, and monitor a controlled harvesting programme.
- ✓ Strengthen protection of woodlots and other forests close to the settlement.
- ✓ Budget for a forest rehabilitation program.
- ✓ When estimating timber demand, add on wood used for cooking and brick-making.  [Ref 3.4 Cooking Options in Refugee Situations](#)

Life Cycle Analysis

The environmental impact of a material itself is measured using Life Cycle Analysis (LCA). LCA includes the environmental impact of production methods, transport, and energy efficiency. The principles of LCA should help inform material choice, even if information for a full analysis may not be available.

 [Ref 3.1 Life Cycle Initiative](#)

A brick house may consume more wood as fuel for firing the bricks than an equivalent timber-frame structure... LCA looks at the big picture.

A.2.2 Protection

Uncontrolled and unregulated cutting of trees to provide timber for construction or fuelwood can cause tension between different communities making claims on limited resources. As forests are depleted, women and girls may be forced to travel greater distances to find timber or firewood, increasing their risk of physical or sexual attack.

A.3 Legal issues

National building and construction regulations and national and international legislation on forest protection must be followed. Contact details for forestry ministries can be found in [📖Ref 2.8 FAO Forestry Contacts Database](#).

Verifiably legal and sustainable wood is often expensive. Weak legislation and the export of sustainable timber by poorer countries can make certifiably sustainable timber hard to find. Organisations must show due diligence in their efforts to identify legal timber.

Ensuring timber is verified as sustainable may mean importing it or waiting for governments to approve release of timber, both of which may be slow processes.

[\[B.2 Source verification\]](#)



NO NATIONAL LEGAL CERTIFICATE AVAILABLE?

In a country without a certification system? Are protected species grown? Unable to verify the timber's source?

Stop! Timber may be illegal! Seek expert advice and consider using other materials.

ONLY A NATIONAL LEGAL CERTIFICATE AVAILABLE?

In a country with a reputation for corruption or poor quality controls? No independent verification of sustainability?

Wait! Despite a certificate, timber may still be from illegal or unsustainable sources. Seek expert advice!

INDEPENDENT LEGAL AND SUSTAINABLE VERIFICATION?

Has timber been independently certified or are local resource-management measures in place?

Go! But remember to prevent the mixing of certified with non-certified timber, particularly on site...

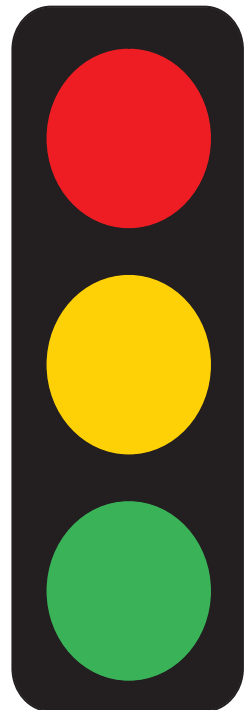

A.4 Markets and supply

A.4.1 Market analysis

A coordinated market analysis can prevent overestimating the supply, and underestimating the demand for timber.  [Ref 2.7 Emergency Market Mapping Analysis \(EMMA\)](#). Correctly assessing local market capacity helps when making a decision on where to source timber and whether affectees can be supported with cash or vouchers to buy their own materials.

This is a small project. I will visit the nearest market and the local suppliers.

Three components of a market analysis are considered below:

Pre-crisis market profile - how did the market perform before the crisis?

- What construction materials are normally available and how much do they cost (retail and wholesale)?
- What materials can be substituted for timber (and vice versa)?
- What fixings are available for timber and bamboo?
- What species are used and is timber certified in any way?

Market diagnosis - how has the market been affected?





- What is the impact on prices and quantities traded?
- What reclaimed or salvaged timber is available?
- What is the gap between need and current supply?
- Is the quality of timber reduced (e.g. shortened drying times)?
- Are local forests under threat?

Market prognosis - how might the market respond?

- Can the market satisfy demand before unacceptably increasing prices?
- Would supporting local markets threaten sustainability of forests?
- What solutions could be provided to reduce market bottlenecks e.g. portable saw mills, assistance with treatment processes?

How much timber is needed.

Approximate volumes of timber in simple structures.

				
Latrine (without slab)	8m x 6m shed	House / classroom	Emergency ridge shelter	Basic timber shelter
0.4 – 0.8m ³	3m ³	2 - 4m ³	0.1m ³	0.3m ³

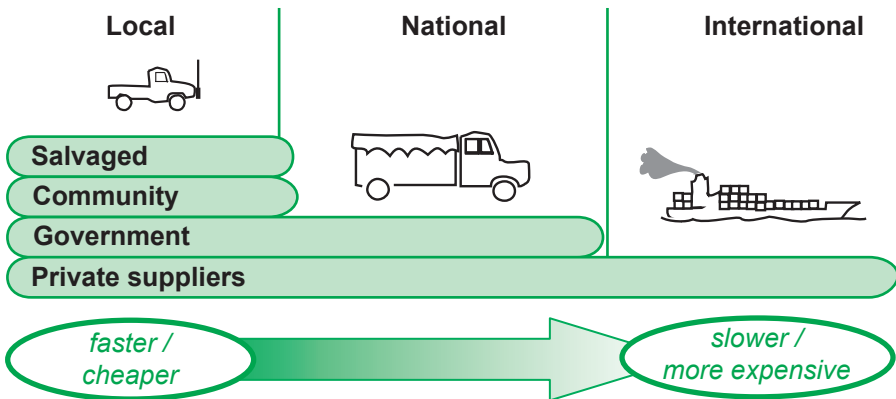

Who will supply the timber? Internationally supplied timber is usually slower and more expensive than local timber, but may be the only option.

A.4.2 Salvaged or recycled timber

Significant amounts of timber construction material may be available from damaged or destroyed houses. Trees may also have been felled during a natural disaster and may be processed and used.

People may collect and reuse material themselves. However, an organisation will need to consider:

- Timber ownership (who did the fallen trees belong to?)
- If help is needed to move logs or trees
- If processing help is needed
- How timber can be cleaned and used safely

See [\[B.3 Salvaging and harvesting\]](#).

I cannot carry this tree home on my own! I need support.

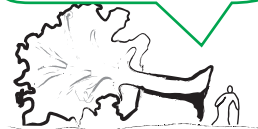

A.4.3 Local markets, forests and plantations

Local forests and markets will be the first place people affected by a disaster look to source materials for repairing homes or building temporary shelters after a crisis. The demand for timber may be greater than local resources can sustainably support. In these circumstances, consider:

- Importing timber, bamboo or other poles into the region
- Training on reducing timber in construction or providing alternative materials
- Long term replantation projects

In locations where the local markets can supply sufficient sustainable timber or bamboo, then organisations may consider providing cash.

[\[B.3 Salvaging and harvesting\]](#) includes community supply of timber and bamboo.

Bamboo is frequently managed at a community level. When large volumes are required, procurement may have to be dispersed over many communities to avoid destroying the bamboo clumps [\[B.3 Salvaging and harvesting\]](#).

A.4.4 National or international supply

If local timber supplies are limited or unsustainable, the government or external organisations may need to provide additional timber from national sources. In many countries there is a nationalised forestry industry and government may be able to provide timber in large volume.

See [\[B - Specification\]](#) for advice on procuring timber from local, national and international suppliers. In general, the further timber travels the longer it will take to supply, though this may not be true if local timber supply is delayed due to drying times.

Due to the high cost of processing and shipping timber, suppliers have particular procedures that humanitarian organisations should be aware of. International suppliers often expect Letters of Credit but this is normally contrary to the procurement policies of humanitarian organisations. As part of preparedness it is a good idea to discuss the following at the beginning of procurement negotiations:

- ☑ Alternative payment methods to Letters of Credit
- ☑ Can the suppliers identify mills, treating plants and shipping agents that will help speed up delivery?
- ☑ What flexibility is there regarding last-minute order changes?
- ☑ Possible pre-inspection of timber at time of loading
- ☑ How any disputes will be resolved

Humanitarian organisations can join together prior to, or at the beginning of, an emergency response to share the above information and:

- Negotiate fast-tracking of construction materials through customs
- Agree on broad standards for construction-grade timber (size standardisation to facilitate substitution, acceptable treatments, agreement on which certifier to use etc.)
- Co-ordinate with relevant authorities. See FAO's database of national forestry authority contacts. [📖Ref 2.8 FAO Forestry Contacts Database](#)

In some situations the government or relevant authorities may restrict the purchase of timber to government approved or owned suppliers.

A.5 Timber and other materials

A.5.1 Timber or bamboo?

A decision on whether to use timber depends upon many factors including the local context. Ask:

Timber or bamboo?	
Is timber or bamboo used in similar buildings already?	If the answer is no then using timber or bamboo may still be possible, but it is more likely to involve a long-term project with intensive training on how to use timber or bamboo as well as a program of cultural acceptability.
Will supply meet demand?	If insufficient timber is available, then it will obviously be difficult to use it! Timber can of course be imported but this may take longer. <i>[A.4 Markets and supply]</i>
Are skills, tools, and fixings for repair available locally?	If people are to maintain buildings unassisted they will need to be able to buy reasonably priced tools, fixings and timber nearby.
Building for safety?	Local risks (such as earthquakes and cyclones), combined with local techniques, may make timber a safer material to build with.
What are the alternatives?	Many other materials can be used instead of timber and their relative advantages and disadvantages must be weighed up against those of timber.

A.5.2 Substitute materials

In many cases, alternative materials to timber can be used. The decision on which materials are to be used will be based on many factors including the design; the intended lifetime of the building; the familiarity of users with materials; the available materials as well as the environmental impacts of the materials to be used *[A.2 Environment and protection]*.

Combination of materials

Often, a combination of materials may be the best option. In settings where timber is in short supply and firewood is a main source of cooking fuel, alternative building technologies such as adobe or stabilised soil bricks should be considered.

When considering alternative materials, check that there are the skills available locally to use them!

For **roof coverings** we could use: thatch; cement tiles; burnt clay tiles, CGI metal sheeting; concrete (flat or vaulted); plastic sheet...

For the **walls and structure** we could use: stones or adobe; bricks; steel beams; wattle and daub; reinforced concrete; bamboo mats...
We could use steel, timber poles or sawn timber or bamboo for a frame...

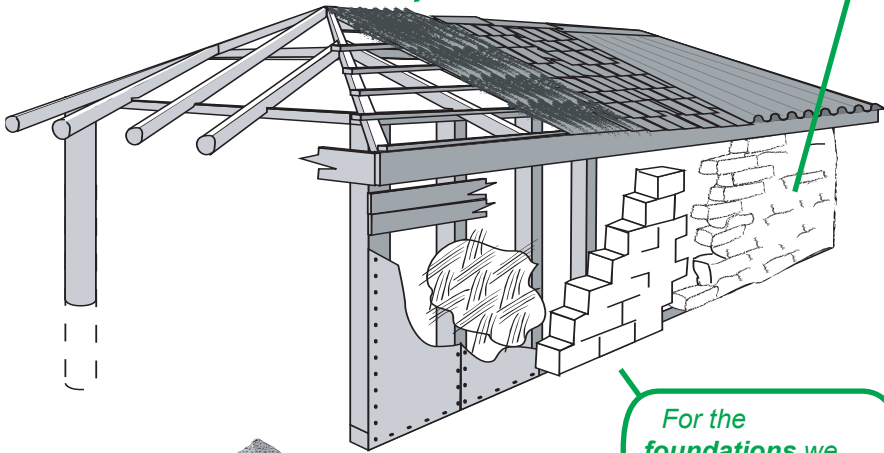

For the **foundations** we could use: reinforced concrete, bricks, stones or timber posts.

For **floors** we could use: earth, concrete, bricks or timber...

Or we could use a combination of materials!

What about the environmental consequences of these materials?



A.6 Who will build and maintain?

People and skills

The majority of post disaster and post conflict construction is undertaken by the affected people themselves, often with little or no assistance.

Approaches for supporting construction are:



1. Affected people construct for themselves:

Those affected build, with support from the organisation.

When suitable: When people have the ability to carry out safe construction themselves.

Quality control: When timber is sourced by the beneficiaries themselves, monitoring teams may be needed. Technical advice on safe construction should be provided, particularly in areas with natural hazards.

Note: Do not assume that everyone has building skills! Ensure the fixings and tools necessary are available. Consider providing vouchers or cash for material purchase.

I am a taxi driver, not a carpenter!

2. The organisation constructs:

The organisation directly hires labour.

When suitable: When people are unable to carry out work themselves or shared infrastructure is being built.

Quality control: Internal quality controls of construction and materials (or a hired inspection service).

Note: Be realistic about internal technical capacity! Follow building, safety and insurance regulations!

This could mean hiring a lot of staff.

3. A contractor is hired:

A construction project is put out to tender.

When suitable: When neither affected people nor humanitarian organisations have the capacity to construct.

Quality control: Organisation must have its own monitoring system in place to check contractors' work. Close control of legality of timber and safety of treatments used.

Note: Check who is legally liable for quality, safety and completion times of construction!

The quality of the wood, its legality/sustainability and treatments used should be specified in contract documents.

We need a clear contract and skilled staff to monitor the contractor.

A.7 Working as a team

Program managers should understand the difference between technical professions. The major roles are summarised below.

Different types of engineer

Engineers can specialise in many different areas such as bridge, road and dam engineering, as well as building engineering. Professionals that specialise in other subjects such as mechanical plant, electrics or electronics are also known as engineers.

A **structural engineer or civil engineer** is responsible for ensuring that a building can support the loads placed upon it (the weight of its own structure, wind loads, seismic loads, snow loads etc.). Engineers working specifically with buildings are sometimes called **architectural engineers**.

*We
needed a
structural
engineer
- not an
electronic
engineer!*

Architects

An architect is concerned with how a building looks and may also be responsible for the overall management of a building team. Architects usually hand responsibility for calculations regarding structural safety to an engineer who will be part of their building team.

The right experts

It is the program manager's responsibility to make sure that they are consulting with technical experts with the right experience. If only working with locally recruited building professionals then get designs and plans run by an independent, external expert with the relevant experience. If the technical expert on your team is an expatriate, make sure they are working closely with local technicians and designers.

More than just a structure

An appropriate building cannot be designed by technical professionals alone. Managers must ensure that technical and program staff such as community liaison officers are working together in the design stage to ensure that buildings not only stand up and stay up, but that people want to use or live in them.

*This is not just an
engineering problem! We also
need community workers to
ensure that the buildings are
what people want.*

Program and technical staff need to work with the logistics department to match building design to materials available.

A.8 Design

A.8.1 Designing a structure

When designing a structure, always have technically skilled staff on the team, and follow local and national building regulations.

The design of any structure should be such that it is appropriate to needs and context.  [Ref 2.1 Sphere](#) contains some standards for emergency contexts.

The engineer has designed a house that won't fall down - but no-one wants to live in it!

The design of a structure using timber must take into account:

- ✓ Local advice, traditional construction and how people will rebuild.
- ✓ Whether improved building techniques can be easily replicated.
- ✓ Maintenance and upgrade at a later stage by the people who use it.
- ✓ Drainage and access to sanitation and infrastructure.
- ✓ Climate.
- ✓ What worked locally and what did not when the last disaster event struck.

Building with hazards

Even though a simple timber structure is unlikely to withstand a severe hurricane, it should be designed to known engineering standards. Good detailing is essential if durability and structural soundness is not to be compromised.  [Ref 8.9 Technical principles of building for safety](#).

Timber is a good material for earthquake-resistant buildings  [Ref 8.1 National Information Center of Earthquake Engineering](#).

Communicating the design

However simple a building may be, plans should be drawn before the structure is built. These plans should:

- Be understandable by those who will be using them.
- Show details of joints and fixings.

From these plans, materials lists or bills of quantity will be developed.

Building a prototype is a good way to demonstrate to people what is planned and to get feedback on the design.

Build it according to this scale plan.

Yes sir!

But I do not understand the drawing.



Can you make a model?

**Do not build unless you are sure the structure is safe.
If in doubt get expert technical advice.**

A.8.2 Efficient timber use

Designs should maximise the efficient use of timber (this is sometimes called 'reduced timber construction') without compromising safety.

Half wall made of masonry (not fully timbered wall)

Door frame doubles as structural element



Use of large roofing sheets rather than tiles reduces quantity of battening required

Examples of techniques to reduce timber in construction

Reducing waste by good design

Design for the lengths of timber available [*B.8 Quantity*] and use combinations of materials. Off-cuts can also be used for lintels, cross-braces etc.

If there are unusable off-cuts, then, if they have not been treated with chemicals, they can be used as fuel, chipped for animal bedding or, in the case of bamboo, used for animal feed.

Efficient use of timber in construction should never reduce stability or strength. Get the design double-checked for safety!

A.8.3 Fire safety

The fire safety of a building depends on the characteristics of the whole structure, not just the materials it is made of. Although timber burns, it normally chars first, creating a burnt seal on the surface of the wood which can slow down or halt burning. Making sure a timber building is fire-safe means getting proper technical advice to assess:

- Means of escape
- Restriction of spread of fire internally and externally
- Load-bearing capacity and integrity (A burning building should stay intact long enough for occupants to escape safely)
- Insulation (making sure parts of a building do not get too hot)
- Fire breaks and spacing between structures.

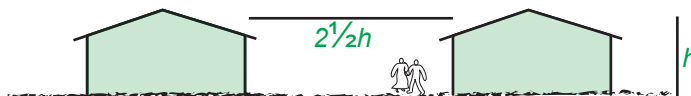

Emergency structures should be spaced $2\frac{1}{2}$ times their height apart to prevent the spread of fire. There should also be regular fire breaks.

A.9 Checklists

A.9.1 Think before you build [A.1]

- Is the project part of a wider strategy?
- Is the assessment being made with the key people involved?
- Are the construction sites suggested appropriate?
- Have land ownership issues been resolved?
- Is a construction project the right answer to meet people's needs?
- What is the anticipated life span of the construction?
- Has a maintenance plan been agreed?

A.9.2 Environment and protection [A.2.1], [A.2.2]

- Has an environmental impact assessment been made?
- What is the status of the country's timber trade?
- Are there particular environmental risks associated with illegal logging?
- Have the needs of vulnerable individuals, women, the elderly and minority groups been taken into account?
- What do environmental organisations and international forestry organisations have to say about the country of operation? [B.2 Source verification]

A.9.3 Legal issues [A.3]

- What are the rules and regulations regarding legality and transport of timber?
- Who should be contacted in which authority for more information (e.g. forestry ministry, environment ministry)?

A.9.4 Markets and supply [A.4]

- Can reclaimed timber be used? If so, how much is there? [A.4.2]
- Have economic impacts of using different materials been considered?
- Has a market analysis of timber been conducted?
- How quickly can timber be imported?

A.9.5 Timber and other materials [A.5]

- What construction materials and techniques are commonly used?
- Have re-usable materials been considered?
- Has the cost of using different materials been considered?

A.9.6 Who will build and maintain? [A.6]

- Can people build their own houses?
- Are there sufficient carpenters / builders for the scale of construction?
- Do people have the means to hire builders?

- ✓ What technical support is needed from external organisations?
- ✓ What are the legal requirements for construction companies and the liabilities of a humanitarian organisation?
- ✓ What are the rules and regulations for hiring staff on construction sites?
- ✓ What are the rules and regulations regarding hiring a contractor?

A.9.7 Design checklist [A.8.1]

- ✓ What are the rules and regulations regarding construction?

Design: safety

- ✓ Has the building been checked by an experienced engineering designer and are technical safety issues resolved?
- ✓ Has the design been double-checked independently by another engineer?
- ✓ Have local/national building regulations been met?
- ✓ Have accepted standards of appropriate engineering been met?
- ✓ Have precautions been taken against local risks such as earthquakes and cyclones?

Design: documentation

- ✓ Have strength calculations been made for critical items?
- ✓ Have joints and other critical components been drawn in detail?
- ✓ Have material and workmanship specifications been prepared?

Design: appropriateness

- ✓ What types of structure do people normally use?
- ✓ Does the design meet the needs of those who will use it?
- ✓ Can local builders understand and build the structure?
- ✓ Are people familiar with design of the structure?
- ✓ Can the structure be upgraded, repaired or adapted at a later stage?

Design: use timber efficiently [A.8.2]

- ✓ Does the construction maximise the efficient use of timber?
- ✓ Has the construction been designed for available sizes of timber and to minimise wastage and off-cuts?
- ✓ Does the structure include different materials including alternatives to timber where appropriate?
- ✓ Does the building take account of the types and qualities of timber available?

For further reading on shelter and settlement programming and environmental assessment see the annexes: [\[ii.2\]](#).

A - Planning

B - Specification

B.1	Developing a specification	21
B.2	Source verification	23
B.2.1	Timber and the law	23
B.2.2	Verifying the chain of custody	24
B.2.3	Certification and auditing	24
B.2.4	Community verification and resource management	26
B.2.5	Direct verification by humanitarian organisations	26
B.2.6	Supplier declarations	27
B.2.7	Importing requirements	27
B.3	Salvaging and harvesting	28
B.3.1	Salvaged timber	28
B.3.2	Bamboo harvesting	29
B.4	Durability	30
B.4.1	Maximising timber's lifespan	30
B.4.2	Specifying species	31
B.5	Drying timber	32
B.5.1	Reducing moisture content: drying wood	32
B.5.2	Drying timber	33
B.6	Treatments	34
B.6.1	When to use treatments	34
B.6.2	Treatment processes	35
B.6.3	Coconut, bamboo and composites	37
B.6.4	Treatment chemicals	38
B.7	Quality	40
B.7.1	Grading classification	40
B.7.2	International standards	40
B.7.3	Visual grading: sawn wood	41
B.7.4	Visual grading: bamboo	44
B.7.5	Visual grading: coconut timber	44
B.7.6	Visual grading: timber poles	45
B.8	Quantity	46
B.8.1	Dimensions	46
B.8.2	Tolerances/deviation	47
B.9	Delivery and payment	48
B.10	Specifications	49
B.10.1	Sample specification - industrial grading	49
B.10.2	Sample specification - visual grading	50

C - Logistics

D - Construction

B.1 Developing a specification

How do I develop a specification?

The diagram below illustrates which parts of this chapter are relevant for different types of purchase.

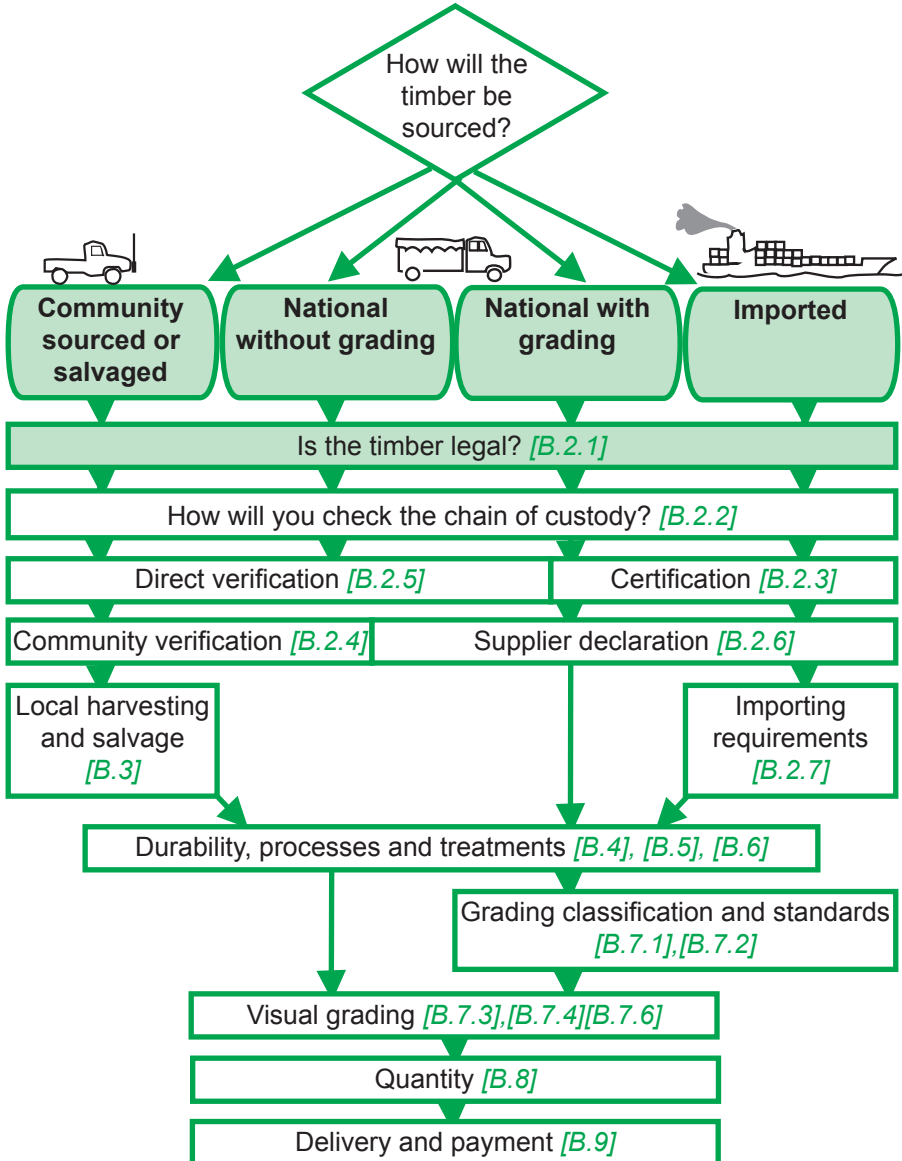

Introduction to specification

This chapter is intended to complement, and not replace, organisations' internal procurement guidelines.

The type of specification, verification and quality control methods that are appropriate will depend a great deal on the issues covered in section A: the phase of the response; the scale of the program; the state of the supply chain and markets, and the degree of forest management within a country.

The logistician and construction designer need to be clear that the right type of timber is being bought for the right purpose.

When creating a specification for a supplier, establish that the timber is:

- ✓ From a legal/sustainable source (requirements may include health and safety conditions in harvesting and processing)
- ✓ Of the right type for the specified purpose
- ✓ Of an appropriate quality
- ✓ Supplied in the right quantity with the right dimensions
- ✓ Treated safely (if it is treated at all)
- ✓ Compliant with customs requirements (if imported)
- ✓ Delivered to the right place at the right time under the right conditions

An example of a co-ordinated specification policy is [📖Ref 5.1 Timber Usage for Tsunami Reconstruction in Indonesia](#).

Not all of the information in this section is suitable for all contexts. Be realistic about the specification you are developing as, in most cases, timber supplied either locally or quickly will not always meet the highest standards.

Working with government

Seek advice from Forestry, Environment and Customs departments on what regulations govern timber supply, construction and chemical treatments (especially if importing).

[📖Ref 2.8 FAO Forestry Contacts Database](#)

Use local knowledge for choosing the right timber for the job. If in doubt, ask!

I will check with the government. They should know what regulations there are.

They may even have useful lists of suppliers.

B.2 Source verification

B.2.1 Timber and the law

There is no single definition of 'legal' timber as different international agreements and national laws cover different parts of the timber industry. Humanitarian organisations should be able to demonstrate that they have carried out due-diligence in ensuring that the timber they use is considered legal in the country of operation and is not a protected species or from a protected forest.

International trade in timber is controlled through the Convention on International Trade in Endangered Species of Wild Fauna and Flora (CITES) and the International Tropical Timber Agreement (ITTA). These agreements are voluntary and implemented through the domestic laws of each participating country rather than by an external international legal body.

CITES is an agreement protecting certain plants and animals threatened by international trade. 172 states are signatories to CITES. Endangered tree species list:

 www.cites.org.

The ITTA (1976, updated 2006) relates to forest conservation and development, and controls for the trade in tropical timber.  www.itto.or.jp.

 *Ref 4.1 Keep it Legal*

Ownership

Natural resources normally belong to an individual, a community, a business or an institution so clarify ownership before purchasing or using locally harvested bamboo or timber (including that salvaged after a disaster). Beware that in some places nomadic or seasonal groups may own the timber. See [\[B.2.4 Community verification and resource management\]](#).

In some communities, particularly in Asia, the owner of the land may not be the same person or group as the owner of the tree, and even different parts of the tree itself (its fruits for food, its leaves and branches for building materials) may be separately owned. Be sure to clarify this early on! [\[B.2.4 Community verification and resource management\]](#)



Stop if you suspect timber is from a protected forest.
Wait and get more info.
Go ahead when the checks are in place.

B.2.2 Verifying the chain of custody

Timber passes through different processes managed by different businesses; from the tree being cut down and sawn, to plywood being sold by a local merchant. The journey timber takes is known as the “Chain of custody”.

The chain can be broken at any point. For it to remain intact it must be possible to verify that no timber from illegal and/or unsustainable sources is mixed in with legal or certified timber.

Organisations can verify sources through:

- Certification and auditing [B.2.3]
- Community verification [B.2.4]
- Direct verification [B.2.5]
- Supplier declarations [B.2.6]

B.2.3 Certification and auditing

National certificates of legality

Always check whether appropriate authorities issue certificates of legality and/or sustainability and follow the law. [B.1 Developing a specification]

In many countries official approval for the release of timber from forests may be a slow process. Investigate the availability of certified, private, sustainable sources.

It is also possible that the national certification process itself may be corrupt. The following are good sources for information on country-level forest management:

📖 The National Forest Program Facility (at www.nfp-facility.org)

📖 WWF’s Global Forest and Trade Network (<http://gftn.panda.org/>)

📖 Forest Law Enforcement and Governance (FLEG) - <http://web.worldbank.org>

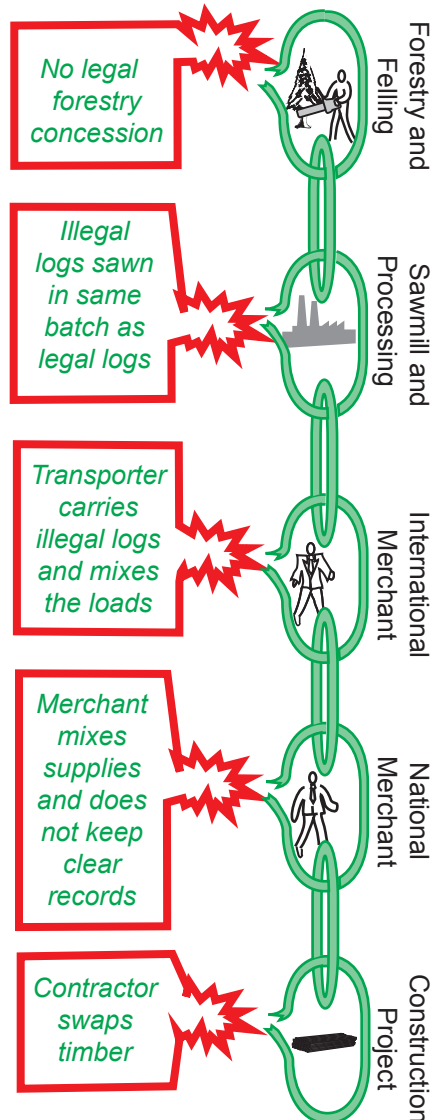





Independent certification schemes

There are a number of certification schemes that verify the chain of custody. Each one has its own criteria for what constitutes 'legality' and 'sustainability'. Most certification bodies will provide lists of suppliers on request.

The World Wildlife Fund for Nature (WWF) has a tool for finding certified companies.  http://gftn.panda.org/practical_info/certified_companies

Some timber certification bodies

Note: inclusion does not imply recommendation. Practitioners are encouraged to make informed choices

Organisation		Description
Forest Stewardship Council (FSC) www.fsc.org		Certification conducted through accredited bodies. Issues updates on certificates awarded.
Programme for the Endorsement of Forest Certification (PEFC) www.pefc.org		Global umbrella organisation for the assessment and mutual recognition of national forest certification schemes.
The Sustainable Forest Initiative (SFI) www.aboutsfi.org		SFI certifies different types of forest products.
Canadian Standards Association (CSA) www.csa.ca		CSA runs a Sustainable Forest Management (SFM) verification scheme.
Malaysian Timber Certification Council (MTCC) www.mtcc.com.my		Operates voluntary national timber certification scheme for legal (rather than sustainable) certification.
Australian Forest Certification Scheme www.forestrystandard.org.au/		Timber products from sustainably managed forests. Mutually recognised by PEFC.

An **Ecolabel** is awarded through third party audit to products meeting certain environmental standards. There are many Ecolabels such as ISO 14001, which shows that a business has met standards for environmental management. Ecolabels are not the same as forest or timber certification.

Independent Forest Monitoring (IFM)

IFM involves the monitoring of forestry processes by an international, independent third party with the agreement of state authorities.

IFM has so far been undertaken in Cambodia, Cameroon, Canada, Ecuador, Indonesia and the Philippines, by both NGO and corporate sector organisations.

 <http://www.illegal-logging.info/> and

 <http://www.globalwitness.org/pages/en/ifm.html>

Private auditing and inspection firms

Private auditing or inspection firms can be hired by humanitarian organisations to verify the timber source. The following verification services are intended as a starting point only and does not imply recommendation:

- Certisource: www.certisource.net
- SGS: www.sgs.com
- Helveta: <http://corporate.helveta.com>
- Track record: www.trackrecordglobal.com
- Bureau Veritas: www.bureauveritas.com

Who is responsible for carrying out and double-checking the verification? Who is checking them?

B.2.4 Community verification and resource management

Community groups can be established to confirm that suppliers are not taking timber from vulnerable areas and for quality control.

An Environmental Impact Assessment may help to identify how a community resource management project could be undertaken. [\[A.2.1 Environment\]](#)

The ownership of a forest may be disputed or unclear, particularly when trees or bamboo are on communal land.

 [Ref 3.6 Revised ITTO Criteria and Indicators for the Sustainable Management of Tropical Forests](#).  [Ref 3.7 CIFOR Adaptive Collaborative Management Program](#)

For more on bamboo crop management, see [\[B.3.2 Bamboo harvesting\]](#).

B.2.5 Direct verification by humanitarian organisations

Organisations can make their own assessments of the area where the timber or bamboo is coming from.

 [Ref 3.3 Guidelines for Rapid Environmental Assessment in Emergencies](#)

Forming a joint-procurement group will help organisations to pool their resources to verify that the timber they are sourcing is legal and sustainable. Use resources are available at  [Ref 4.3 Central Point of Expertise on Timber \(CPET\)](#).

Let us go and have a look!

B.2.6 Supplier declarations

Supplier declarations can be one part of a process in verifying the legality or sustainability of timber.

Checklist for a supplier declaration

- ✓ A description of the timber supply chain up to the supplier in question
- ✓ The controls that are in place to prevent mixing or substitution
- ✓ Management of the implementation and adequacy of these mechanisms
- ✓ Signed confirmation that information is up-to-date and correct

B.2.7 Importing requirements

Check the requirements for importing timber. Some countries have strict control over treatments used, species and volume of imports. Paperwork can be time consuming!

Phytosanitary certificates are issued by quarantine authorities or agriculture ministries for raw timber products. Certificates issued by the country of export may not be considered valid by other countries, so check first.

Processed timber composites or chemically treated timber should not require phytosanitary certificates. Untreated wooden pallets used for packaging will.

Preparing paperwork in advance can avoid timber being stuck in port. Paperwork can take a long time!

Phytosanitary certificate checklist

- ✓ Details of packing
- ✓ Botanical tree species names and whether softwood or hardwood
- ✓ Country where tree came from
- ✓ Serial numbers of phytosanitary certificates issued in the country of origin (import if timber is re-exported)
- ✓ Dimensions/weight of packaging plus volume of wood in m³
- ✓ Name/number of boat or plane
- ✓ Wood treatment type (e.g. Chemical Pressure Impregnation)
- ✓ Name of chemical used
- ✓ Duration of treatment applied for effective treatment
- ✓ Dosage rate of chemical (number of grams per m³)
- ✓ Date of treatment

B.3 Salvaging and harvesting

B.3.1 Salvaged timber

Following a disaster, affected people usually reclaim timber. However, support may be required to help to establish ownership, to collect and to clean the timber.

Salvaged timber may not be as strong as you expect.

Establishing ownership

- For timber that has been washed away, by water or landslides, local laws will have to be consulted or rules established.
- For timber that is not washed away, usually the land owner or the house owner owns the timber. However there may be issues with rented or squatted land or with timber on common or government land. [Ref 2.3 Transitional Settlement and Reconstruction after Natural Disasters](#)
- Where ownership is disputed, consult with local authorities.

Collecting the timber

- For timber that has been washed away, help might be required to retrieve it. This is especially the case for large volumes of wood or entire trees that might be usable but are too heavy to move.
- For trees that have fallen or been damaged, rapid harvesting, milling and undercover seasoning of fallen timbers will greatly reduce 'spoiling'.
- Consider provision of tools such as portable saw mills to process timber where it has fallen.
- Trees that have lost their leaves but are still standing, may still be alive. Such trees should be left for three months to see if they re-sprout.

Cleaning and drying the timber

- Clean timber with water and tools, dry it (e.g. in the sun) and keep it dry.
- Take care if there is concern that it might be contaminated with bacteria or hazardous chemicals.
- All nails, screws and bolts should be removed. A cheap hand-held metal detector will help with this.

This timber is covered with mud – we need to clean it...

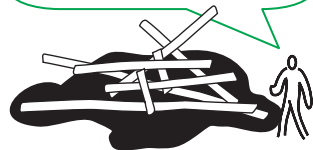

Using the timber

- Reclaimed timber may be damaged and not safe for structural use. Cleaned timber should be carefully sorted and checked for quality. Poor quality timber can be used for non-structural purposes. [\[D.6 Poor quality timber\]](#).
- Salvaged or reclaimed timber may contain rotting or decayed sections. Check carefully to prevent infecting other timber.
- Recently fallen trees should be seasoned before use. Otherwise use "green timber" construction techniques. [\[D.5 Unseasoned timber and coconut\]](#)

B.3.2 Bamboo harvesting

Although humanitarian emergencies may require that bamboo be harvested at any time of year, good crop management and harvesting procedures can greatly increase the productivity and durability of bamboo crops.

Good crop management can strengthen the disaster preparedness of a community. Bamboo clumps provide not only materials but can reinforce flood-prone embankments and protect buildings from strong winds.

Good management practices may increase crop production by up to 600%. Around a quarter of a healthy bamboo clump can be harvested each year. Incorporation of bamboo planting and harvesting training into construction projects helps communities' capacity to grow their own homes.

Are bamboo culms carefully selected from clumps?

Best practice guidelines for crop management

1. Harvest after the end of peak growth periods (rainy seasons) and not immediately before or during to ensure the greatest return

2. Harvest when sap sugar levels are lowest (especially if bamboo will not be treated) i.e.

- ☑ Outside of the main growth/rainy seasons
- ☑ At dusk or dawn (sap levels are highest in daylight hours)

3. Use bamboo culms of the right age

- ☑ Culms should be at least 2 years of age.
- ☑ Culms over 5 years old are not usually suitable for construction (check local knowledge for species variation). Thinning out older culms lets in more light, promoting growth rates of new culms. Older culms might still be used for temporary or emergency low stress structures.

4. Identify mature culms for harvesting

- ☑ Generally culms under two years old still retain juvenile leaves at each node, in most species these dry out and drop off over time.
- ☑ At 2 years of age, vertical wrinkles or creases appear between nodes on each culm, indicating the culm has dried out and toughened up
- ☑ Older culms lose their green (youthful) colour and may show signs of mould and mildew

5. Cut carefully to minimise risk of fungal infection to the root system

- ☑ Each culm should be cut clear of the ground (20-40cm)

6. Care should be taken when harvesting

- ☑ Do not allow the new shoots to be trampled at the base of the culm

B.4 Durability

B.4.1 Maximising timber's lifespan

Durability is a measure of the time timber or bamboo can perform as intended (and is not the same as strength). Durability can be degraded by:

- Changes in the moisture content (causing swelling and shrinking)
- Mechanical damage (handling)
- Biological damage by insects and fungi

Measures to minimise damage are:

- Choosing the right species of timber [B.4.2]
- Keeping timber at the right moisture content [B.5.1]
- Good storage and careful handling [Section C]
- Good design [A.8],  Ref 1.3 *Timber Design for Durability*

*Timber
can get
damaged -
look after it!*

While this should protect most timber in most situations, sometimes it will need to be treated [B.6 *Treatments*].

 Be aware that all treatments have risks associated with them.

Insects and fungi

Fungi and most insects require damp wood to grow and live in. However some species of termite can attack dry wood so ensure that you know the local species of pest.

[D.4 *Termites, pests and rot*]

*Keep
timber dry
and keep
pests away!*

Use class

To know what species of timber to specify, or what treatments should be applied, identify what conditions it will be used in its 'use class' (sometimes known as 'hazard' or 'risk' class). Classification varies from country to country.

Use class. Adapted from  Ref 1.3 *Timber Design for Durability*

Class	Exposure and example
1	Inside, above ground (200mm above for frames, 150mm for siding), protected from weather/insects – frames, roof trusses, floors
2	Inside and above ground but at risk from termites or slight wetting
3	Outside but above ground - cladding, deck framing, hand rails, fascia, plywood used for concrete formwork
4	In contact with the ground – fence posts
5	Timber exposed to 'continual wetting' - building poles and stumps
6	Marine use – marine piles and timber in contact with salt water

This classification system helps in discussing timber or treatments with suppliers.

B.4.2 Specifying species



Trees are either softwoods (needle-like leaves) or hardwoods (broad-leaved) though, confusingly, this does not always mean that hardwoods are denser or more durable!

A tree has both a botanical, or Latin, name and a common name. As common names vary locally and between countries, clarify the botanical name in the specification process where possible.

Ref 6 Species

Some species, such as some redwoods and cypresses, are naturally more durable than others. Many naturally-durable species are slow-growing, expensive hardwoods that are too costly to be used for construction. Check locally to find out which species available have the right durability for each job.

Within a tree the sapwood is less durable than the heartwood (middle of the trunk).

Hardwoods and softwoods may both need treatment depending upon application. See  Ref 1.3 Timber Design for Durability and  Ref 6 Species for which species fall into which class.



softwood



hardwood

Natural durability classification Ref 1.3 Timber Design for Durability

	Durability	Durability in the ground (years)	Durability above the ground (years)
	Highest	25+	40+
	High	15-25	15-40
	Moderate	5-15	7-15
	Low	0-5	0-7

If importing timber, find out how different the properties of the species supplied are compared to local species used. Try to match species with similar properties - people used to working with dense hardwoods may find that their usual construction methods are not appropriate to imported softwoods.

B.5 Drying timber

B.5.1 Reducing moisture content: drying wood

Wood drying ('seasoning') reduces the moisture content (MC) of wood in a controlled way. Dried wood is generally lighter, stronger, less likely to split or warp, and is more resistant to pests. It is also more expensive, more difficult to procure and handle than green (unseasoned) timber [D.6 *Poor quality timber*].

MC is calculated as a percentage. As the moisture present in wood can weigh more than the dry weight of the wood itself, it is possible to have a MC of over 100% when timber is green.

$$MC = \left(\frac{\text{Wet weight}}{\text{Oven-dry weight}} - 1 \right) \times 100$$

To measure Moisture content:

Take a sample of timber several centimetres long from a part of the board free from knots and irregularities, 50cm from the end of the board. Weigh it immediately.

Dry in a slow oven or microwave at a temperature high enough to evaporate off water but not bound oils (100-105°C).

Weigh it at regular intervals until it has reached its lightest, oven-dry weight (this may take between 12 and 48 hours in an oven).

Drying timber to a moisture content of 12% is normally required in low-humidity countries. In the tropics, 14-18% may be acceptable, while in dry, mountainous regions, 8%-12% may be a reasonable tolerance. Follow local advice.

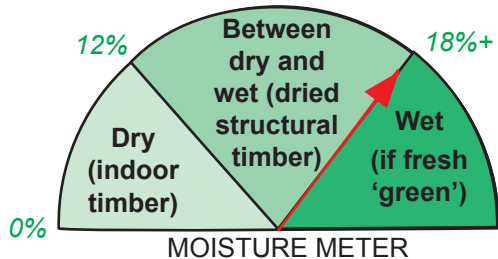

Those who have experience of working with timber will be able to make rough judgements on the MC of timber by sight. However, MC can be measured with a moisture meter (an electronic meter with two metal pins that are inserted into the timber).

Problems with dried timber

Dried timber used in humid environments can swell as the timber re-absorbs water. Doors and windows may not open and close properly and extreme changes in moisture can dangerously damage structural timber. See [D.4 *Termites, pests and rot*] for designing for changes in timber moisture.

B.5.2 Drying timber

There are several processes for drying timber. Drying processes can lead to warp, discolouration, checks and cracks [B.7.3]. Structural timber that is heated over 100°C during drying can be weakened.

Air drying

Air drying is an economical but long process, and as a result is very common with locally purchased timber. Exposure to natural air can reduce MC to below 20%. For a 2.5cm thick piece of timber, air drying takes around one year (depending on the species). The ends of the timber lose moisture fastest and are commonly sealed or painted to protect them.

When air-drying either bamboo or timber there must be spacers not only between the stacks but also between each layer in the stack.  [Ref 9.2 Air-drying of lumber](#)

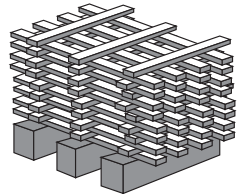

Air drying by stacking timber so that air can circulate around it.

Kiln drying

Air is heated and then circulated around the timber in a closed chamber (kiln) by a fan. It dries timber or bamboo in a quick and uniform way (from a few days to weeks). Kilns can be electric, solar or fuel (e.g. oil) powered.  [Ref 9.1 Dry Kiln Operator's Manual](#)

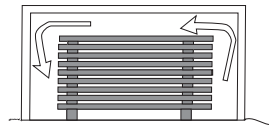

Kiln drying in controlled temperature and humidity.

Solar drying

Solar drying involves drying timber in a container that magnifies the heat of the sun through plastic or glass windows to speed up the drying process. Examples can be found here: www.builditsolar.com/Projects/WoodDrying/wood_kiln.htm.

Industrial-scale solar drying equipment for bamboo has been developed and could be considered as part of an economic regeneration reconstruction project.

Steam and Vacuum drying

Timbers are heated in a closed chamber or placed in a vacuum chamber before further air drying to accelerate the water evaporation.

Water seasoning

Timber or bamboo is kept in water for several weeks before air- or kiln- drying. This makes the wood or bamboo more porous for quick drying and makes them less attractive to fungi and insects by washing out the starch (food).

B.6 Treatments

B.6.1 When to use treatments

In general, structures should be designed so that treatments are not required [*D.4 Termites, pests and rot*]. However, chemical treatments can improve timber's durability against wetting, fungi and insects, weathering and even fire.

Details on treatments can be found in Chapter 14 of  *Ref 1.1 Wood Handbook*.

Do we really need to use treated timber?

Should a treatment be used?

- Have all non-chemical options been considered? (resistant species of timber [*B.4.2*], protective design)
- Are there any national restrictions on the use of certain chemicals?
- Are treatments normally used in the locality?
- Do you know which is the right treatment for the right job?
- Do you know what quantities to use the treatment in?
- Can treated wood be maintained with timber and treatments available locally?

Treatments are most commonly used for:

- Timber which will be exposed to risks. Especially timber in contact with the ground or exposed to termites. See [*B.4.1 Maximising timber's lifespan*]
- Timber types with low resistance to decay or insects (e.g. many softwoods)
- Timber cut from the sapwood of a tree rather than the heartwood.
- Bamboo, which has low natural durability

Treatments may be toxic

Treatments may be toxic to people, animals or water supplies. For guidelines:

 *Ref 10.1 Environmental Health and Safety Guidelines*.

Chemical facts:

 *Ref 9.6 Pesticide Information Profiles*.  *Ref 9.7 ToxFaq*.

Is it safe to use this treated timber for this purpose? Might it be misused later?

Use with fixings

Be aware some treatments may damage fixings. Preservatives with high levels of copper, such as Copper Azole (CuAz) and Alkaline Copper Quaternary (ACQ), corrode galvanised steel nails, screws and bolts [*D.3.3 Nails / screws / washers / bolts*].

Some treatments can corrode galvanised steel nails



B.6.2 Treatment processes

Treating timber

It is possible to treat timber after purchase, or on site using the following methods:

- **Brushing** or spraying - Preservative solution is sprayed or painted onto the timber. Additional coats will improve the effectiveness.
- **Dipping** - The timber is dipped for a few seconds or minutes in a bath of preservative.
- **Soaking** - (also known as diffusion). The timber is submerged in a tank of preservative for days or weeks. The depth of penetration of preservative solution is increased if it is heated.



Treatments can be applied with a brush

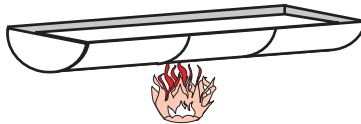

Timber can be soaked in a tank of solution. This is best if the solution is heated first.

Effectiveness

The effectiveness of a treatment depends on the chemicals used [B.6.4 Treatment chemicals], and how far the treatment has penetrated the wood.

Can we buy pre-treated timber?

Industrial processes

Suppliers may also offer timber treated using the following processes:

- **Pressure treatment** - The timber is loaded into a large tank that is pressurised. The treatment solution is then added under pressure. The excess is then removed under a vacuum.
- **Heat treatment** - Heat treatment is a large scale process that alters the structure of the wood reducing risk of insect attack, without using chemicals. Research on the long-term performance of heat treated timber is ongoing.

Treating poles, coconut and bamboo

The following treatment methods are additionally possible for poles, bamboo and coconut timber.

- **Vertical soak** (sap replacement) - the base of a tree or bamboo culm with leaves still on is placed in a tank of preservative. [Ref 9.10 Vertical Soak Diffusion Treatment Manual](#).
- **Pressure treatment** (sap displacement or 'Boucherie' method) - for green logs or bamboo. [Ref 8.8 Timber Pole Construction](#).

Vertical and horizontal soaking methods take between 3 days and 2 weeks and are less equipment-intensive than pressure methods.

[Ref 8.10 Building with Bamboo](#). [Ref 9.9 Bamboo preservation](#)

Temporary protection can be given to timber by charring the outside of it. This treatment should only be used for cheaper timber, such as fence posts, in contact with the ground.

Using treatments

Strict health and safety guidelines should be followed if applying treatments locally. Consider the potential risks of having treatments applied by people who are not familiar with them and plan for training time.

Always ensure health and safety regulations are followed, including for disposal of treatments [C.6 *Health and Safety*].

Timber or bamboo should always be dry before treatment. Poles must be de-barked before treating.

The quantity, concentration level and treatment time of preservatives varies according to the species, the use class, and the finish of the wood.

Treated wood that has been sawn afterwards should have the ends sealed (linseed oil is useful for this).

Treating timber already in use

Treatments can be applied remedially to timber, but it is better to pre-treat timber before use, especially if it is to be used in the ground. 'Bandages' soaked in treatment (e.g. borate) can be wrapped around the timber, or the hole in which the post is set can be flooded with treatment. This is not necessarily recommended for residential buildings. See [Ref 1.1 Wood Handbook \(Chapter 14\)](#).

Painting

Painting timber increases its durability by creating a barrier against wetting. The paint film must be maintained regularly. In the long term, paints do not effectively protect against rot or insects (though some paints have been developed with added preservatives).

Latex paints are more durable and breathable than oil-based paints and a well-painted building will only have to be painted once every 7 years. Always make sure timber is dry before painting. [Ref 9.8 Why House Paint Fails](#)

Can we treat it safely?

I have sawn off the ends of a treated pole... I now need to treat the ends to stop termites crawling up the middle of it!

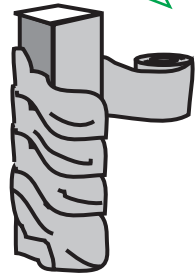

Applying bandages soaked in preservative to treat timber already in use.



Painting can create a short term protective barrier for timber.

B.6.3 Coconut, bamboo and composites

Coconut timber treatment

As coconut timber has very open pores, treatment and drying times may be a little quicker. It is also advisable to dip or spray coconut timber with borax before stacking. [[C.3 Storage](#)]

 [Ref 7.5 Coconut Palm Stem Processing Technical Handbook](#)

Bamboo treatments

Bamboo is normally supplied untreated unless otherwise specified. In the emergency response phase, treatment may be unrealistic, whilst for permanent reconstruction it is essential. Untreated bamboo has a lifetime of:

- 1-3 years in contact with the soil
- 4-6 years under cover
- 10-15 years under cover in a non-humid climate.

Composites (plywood and OSB) treatments

The glues that hold composites together can be treated during manufacture. Solvent based glues resist insect attack better than animal or vegetable based glues. Many modern plywoods are well protected against biological degrading. Fire retardant can also be applied.

Always check the chemical treatments used during the manufacture of the board, as some can contain carcinogenic particles.

If boards have not been pre-treated during manufacture then they can be protected against fungal and insect attack by dipping the entire board in a copper based solution for three minutes. However, test that this does not cause a sample board to de-laminate before treating large numbers of boards.

B.6.4 Treatment chemicals

There are many commercial treatments available, but they are generally based on a few combinations of chemicals. Some are more readily available in some parts of the world than others and they have different purposes.

Some treatments have dyes in them to help with even application and to identify treated timber.

WARNING! Creosote and CCA (Copper Chrome Arsenic) treatments, are NOT recommended for residential use other than for foundations.

If no commercial treatments are available and timber must be treated consider using linseed oil or a 1:2 mix of waste engine oil and diesel for at-risk timbers.

Treatments can be divided into the following categories; Oil-borne, Light organic solvents and Water-borne (see [B.4.1] for more on use classes):

Oil-borne preservatives

V=vacuum, P=pressure, D=dipping/soaking, B=brushing/spraying

Description Often applied as a paint, though sometimes under pressure, they are good water-repellents and do not cause swelling. Note that water-repellency will not last for the life of the timber.

Used for Heavy-duty, industrial purposes

Examples

Name	Use class	Method	Notes	Lifespan (years)
Coal-tar Creosote	4,5,6	VP, DB	☠ Highly toxic! Pigment Emulsified Creosote (PEC) is a slightly less toxic alternative	25-50
Linseed oil	1,2,3	DB	Low toxicity. Increasingly available as a commercial treatment (with added preservatives)	5-10
Engine oil/ diesel mix	4	DB	Should only be used on timber sunk into ground	5-10
Pentachloro-phenol	5, 6	VP	☠ Highly toxic! Suspended in petroleum oil	25-50

Light Organic Solvent Preservatives (LOSPs)

Description Relatively low-pressure treatments using white spirit as the solvent.

Used for Normally for Hazard Classes 1, 2, 3, often for joinery.

Water-borne preservatives (including boron)				
V=vacuum, P=pressure, D=dipping/soaking, B=brushing/spraying				
Description	Fungicide/insecticide dissolved in water, sometimes with an added dye. As the treatments are water-based they may cause timber to swell.			
Used for	If applied using high-pressure, the treatment can be fixed and timber be used in all classes. Otherwise treatment is generally for timber used internally.			
Examples				
Name	Use class	Method	Notes	Lifespan (years)
CCA: Copper Chrome Arsenic		VP	Chrome locks treatment into timber but evidence of arsenic leaching has led to a ban on CCA for some uses in some countries. Treated wood is normally green.	25-50
Ammoniacal Copper Quaternary (ACQ)	3,4 & bamboo	VP	Corrosive to mild steel fixings and fittings	25-50
Copper azole	3,4	VP	Outdoor use. Treated wood is green.	
Borates	1,2 & bamboo	VPDB	Low toxicity compared to treatments containing copper/heavy metals. Borate compounds do not become fixed in wood and can leach out so should only be used indoors.	
CCB (Copper Chrome Boron)	3,4	VPD	Higher toxicity than borates alone, but is not so easily washed out.	
Bifenthrin and permethrin sprays	1,2	B	Anti-insect spray for indoor use. Less effective when exposed to sunlight.	

B.7 Quality

Unless sourcing timber from a large supplier operating in a country with a developed timber grading industry, the quality of timber supplied may be quite variable. Consider this when deciding on the quantity!

B.7.1 Grading classification

Construction-grade timber can be strength-graded by eye, by machine or a combination of the two.

Grading systems differ from country to country. Many countries have no system at all. A good summary of different grading systems around the world can be found in "Information Note 1" from [Ref 1.2 FAO Tsunami Documents](#)

Grading classification may be known as 'strength' or 'stress' grades. Certificates are usually provided by independent grading bodies, authorised to verify whether specific quality standards (which also vary from country to country) are being met by a supplier.

Graded timber stamped by a grading authority will look something like this:

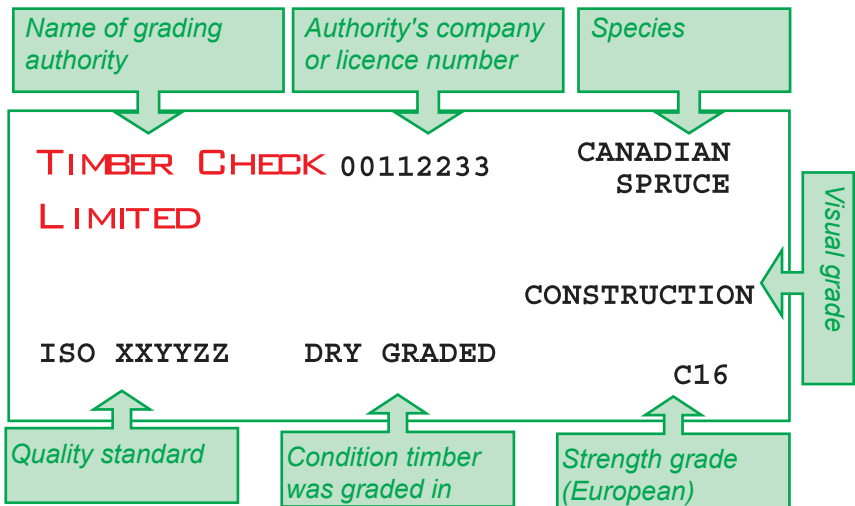

In the absence of a grading system, particularly when making smaller, local purchases, you can use some of the visual grading guidelines below.

B.7.2 International standards

Some suppliers may state that their timber meets international quality and safety standards such as those from the International Standards Organisation (ISO).

Be realistic - local suppliers will not be able to provide the same quality as international exporters!

Some relevant ISO standards (available from www.iso.org.)

- ISO 13912:2005: Structural timber. Machine strength grading. Basic principles (2006)
- ISO 21887:2007: Durability of wood and wood-based products. Use classes (2006) Also European standards: EN 335-2:2006 (definition of use classes) EN 351-1:2007 (preservative retention)
- ISO 9709:2005: Structural timber. Visual strength grading. Basic principles (2006)
- ISO 22156:2004: Bamboo. Structural design for Standardization (2006)

B.7.3 Visual grading: sawn wood

Visual grading is a way of classifying the quality and properties of timber. The permissible deviations of any defect vary depending on the grade of the timber (i.e. what it is to be used for).

Professionals undergo considerable training to become qualified in visual grading. However, in circumstances where small quantities of timber are being purchased logisticians may often be involved in evaluating deliveries [*C.2 Reception*].

At the most basic level, check the surfaces for the defects listed below and sight timber along its length to see if it is straight. If substandard timber cannot be returned, it can be used for other purposes. [*D.6 Poor quality timber*]

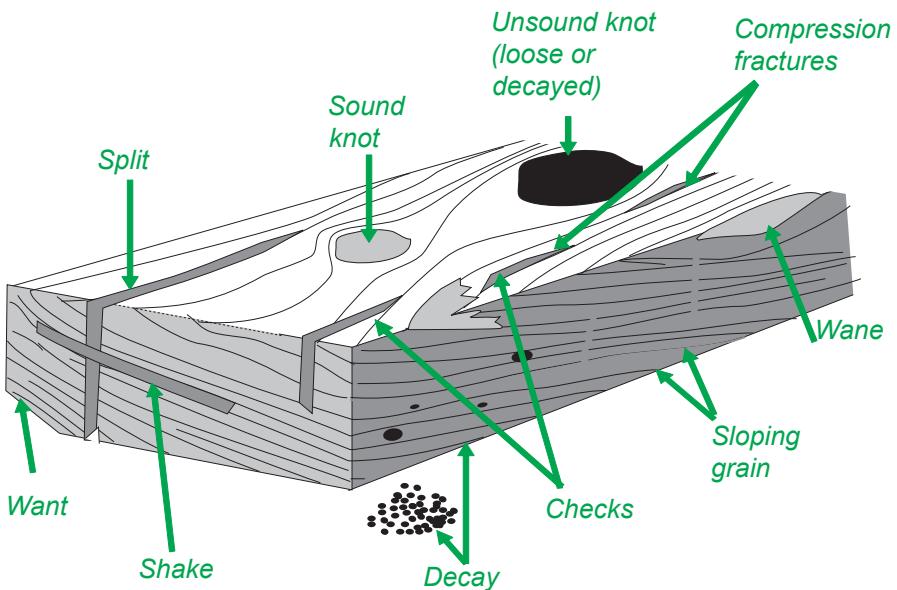

Visual grading of sawn wood

Checks

A separation of fibre bonds across the annual rings that does not carry all the way through an edge or face of a timber board.

Measure: The length of the checks and divide by the board thickness.

Specify: A limit on the absolute length of checks or as a maximum width of the board.

Compression failure

Cracks across the grain, and is due to excessive compression.

Specify: Timber should be free of all such fractures.

Decay

Damage caused by fungus, bacteria or pests.

Look for: Signs of fungus or insects:

- Fine sawdust or holes.
- Wood is soft and breaks along the grain.
- Wood breaks into cubes and has a cotton-thread-like consistency.

Specify: Free of fungus, bacteria or pests.

Knots

Knots are formed where branches grow out of the main tree trunk.

Sound knot: As strong as the surrounding wood and shows no sign of decay.

Unsound knot: Is a weakness, and is softer, chipped or shows signs of decay.

Measure: The width of the knot divided by the width of the timber. Also the number of knots per metre along the timber.

Specify: Limits on knot sizes for sound and unsound knots.

Sapwood

Sapwood [*B.4.2 Specifying species*] is less strong than the heartwood. In softwoods it is treated to improve its durability.

Specify: If a hardwood is being ordered then it should be considered as 'wane' (see below).

Shake

A separation or a weakness of fibre bond between the annual rings. Shake affects shear strength more than compression strength. It can also allow water to enter the timber leading to rot.

Measure: Length of open shakes (cracks) divided by plank thickness.

Specify: Maximum length of open shakes (cracks) as a fraction of timber end width. E.g. less than ½ of end width.

Sloping grain

The gradient of the grain in relation to the length of the timber. This can be measured with a grainscribe (which consists of a sharp needle on a free swivelling arm of known length).

Specify: A gradient.

Split

A separation of fibre bonds across the annual rings that continues through to an adjacent or opposite side of the timber.

Specify: The allowable length of the split from the end of the board.

Wane and want

Wane is the absence of wood from the face or edge of timber due to the board being cut near the edge of a log.

Want is the absence of wood due to some of the timber being split off in processing.

Measure: The percentage (or fraction) of the width (or thickness) of the timber.

Specify: Maximum wane or want allowed.

Warp - Any variation from a true, flat surface.

a) Bow warp

Curve along the length of a board (along the grain).

Specify: Deviation per unit length.

e.g. Maximum 1cm per 3m length.

**b) Spring warp**

Curve along width of board (across the grain)

Specify: Deviation per unit width.

e.g. 1mm/100mm width.

**c) Cup warp**

Curve along edge of a board but not affecting the face (along the grain)

Specify: Deviation per unit length.

e.g. Maximum 1cm per 3m length.

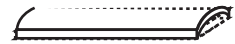
**d) Twist or curve warp**

Twisted distortion along the length of the timber

(Along and across the grain)

Specify: Deviation per unit length

e.g. Maximum 1cm per 3m length.



B.7.4 Visual grading: bamboo

Visual grading of bamboo
Species
Use local knowledge to select right species and use samples to make sure the right species is supplied.
Treatment
Coloured dyes in treatment will help to identify what has and hasn't been treated.
Moisture content
Can be specified as a moisture percentage if feasible, otherwise colour can be specified.
Age
Checking the specified maturity of bamboo is best done before it is cut.
Insect/decay
Specify that bamboo with visible holes from borers or decay is unacceptable.
Taper
Taper is the natural thinning of bamboo towards its tip and the limit should be expressed as a measurement of diameter.
Damage
Bamboo should not be split or crushed.

B.7.5 Visual grading: coconut timber

See  [Ref 7.5 Coconut Palm Stem Processing Technical Handbook](#) for further details on visual grading of coconut and palm timber.

B.7.6 Visual grading: timber poles

Visual grading of timber poles

Taper

Taper is the natural thinning of a pole towards its tip.

Specify: The change in diameter

eg. be less than 5-10mm per metre of pole length.



Crook and sweep

'Crook', where a pole is crooked.

'Sweep', where a pole bends like a banana.

Poles are usable if the sweep or crook deviation never falls beyond the central axis of the pole.

Specify: Draw an imaginary line from end to end

of the pole and there should always be a part of the pole in the axis).

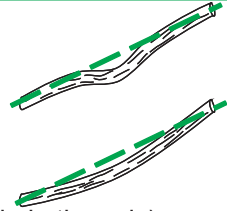

Spiral grain

Poles from trees that have grown in a twisted manner.

Specify: Reject poles with spiral grain.

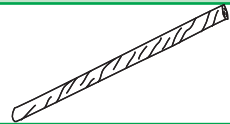

Splitting

Poles might be split at the ends.

Specify: No splits larger than 100mm should be present at the ends of the poles.

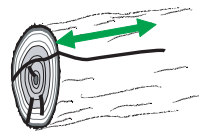

Degradation

Specify: Poles showing insect or fungal attack should be rejected.



Damage

Specify: Reject poles that have been crushed or split.

B.8 Quantity

The cost of timber may be given per volume or per length. Clearly specify both or you may end up with the right volume but the wrong lengths or vice versa.

Depending upon your confidence in the quality of timber being supplied, add between 5% and 20% to any order. This is for wastage in transit.

If the designer had spoken to the logistician, I would not have all of these off-cuts...

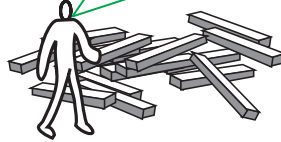

B.8.1 Dimensions

Sawn timber is specified by length and cross-section. Poles or bamboo are specified by length and diameter. Standard dimensions vary, so check what is available and design accordingly.

Designers, builders and logisticians should agree on the lengths to be purchased. Oversized lengths may be required so that defects can be cut off.

Finishing and sawing

Timber finish can be specified as "rough sawn", "gauged" or "finished" (other terms may be used). Finished timber is commonly used for joinery (e.g. furniture and window frames) and is more expensive.

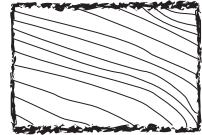

Rough sawn

- Planing timber will result in a loss of thickness.
- Logs may lose 30-40% of their volume in wastage when being cut down to size.
- Finishing timber can lose up to 10mm in thickness!

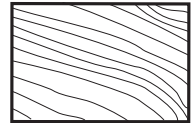

Finished

Some local or national mills may be able to cut sawn timber to specific sizes if the volume of the timber is worth their while, though this will incur extra costs.

Composites finishing

When specifying quality you may be asked if plywood and other boards should be "PTS" (plugged, touched and sanded) or WBP (water and boil proof).

Some conversion factors

*1 inch = 2.54 cm = 25.4mm
1 ft = 12 inch = 0.3048 m = 304.8mm
1 yard = 3 ft = 36 in = 0.9144 m
1 cu foot [ft³] = 0.0283 m³*

Remember: a 2" x 4" timber is equivalent to, but slightly smaller than a 50mm x 100mm timber.

B.8.2 Tolerances/deviation

No piece of timber is exactly the same as another piece: tolerance is the accepted deviation from the dimensions specified. It is normally expressed in millimetres for cross-section or percentage for lengths.

Different countries have different quality standards for acceptable deviation in structural timber and this deviation may vary for sawn or machined timber.

British Standard BS EN 336 specifies the following acceptable deviations

Cross-section size (mm)	Rough sawn timber (mm)	Finished timber (mm)
≤ 100	+ 3 to -1	+ 1 to -1
> 100	+ 4 to -2	+ 1.5 to -1.5

Shrinkage

Timber shrinks as it dries causing differential movement and warping.

Shrinkage occurs more across the width of a timber board than along its length. It occurs more across the grain than along the grain.

Timber will normally curve away from moisture and towards warmth and dryness (the sun). This is due to the moisture differential within the timber and is not generally permanent.

The amount and direction of the shrinkage of wood will depend on its species moisture content and how it is cut from the tree.

Ask the supplier about any potential problems with distortion of timber due to moisture changes during transport or in storage.

Bamboo shrinks more than wood. It particularly shrinks in cross sectional diameter and in wall thickness.

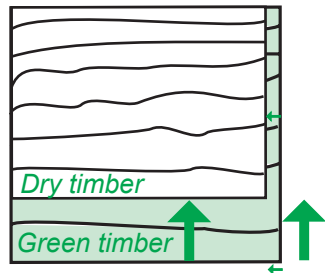

Timber shrinks more across the grain than along the grain

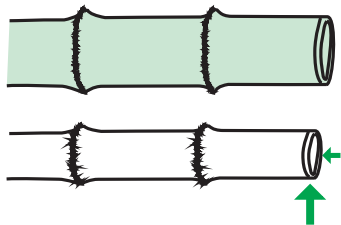

Bamboo shrinks more in the wall thickness and along the cross section than along the length

B.9 Delivery and payment

Delivery conditions

Delivery conditions should establish:

- Delivery schedule – when the timber will be delivered
- Where and how the timber will be delivered
- Cost and organisation of loading / unloading
- Cost and organisation of any on-going transport
- What unloading equipment is required / available
- How timber will be packed (do you need to be able to load and unload timber by hand?)

They said that timber would be here two months ago and we are still waiting. We are not happy.



Lead-times should realistically be agreed and fixed in the contract. Beneficiaries need to know when they can expect construction to begin.

Contracting out procurement may be one option for speeding up the process, though in a situation where the timber market is under pressure, private companies may have just as many problems as humanitarian organisations in securing timber from limited sources.

As with all supplies, the delivery should be checked in terms of quality and quantity before being accepted.

Payment

Contracts should clarify who is responsible for:

- Cost of packing materials
- Costs of delays
- Import fees
- Payment process
- Insurance
- Damages (and compensation rate for damaged goods)

It got damaged in transport! Not my fault. I want my money in full.

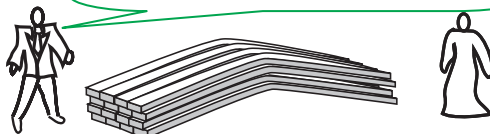

B.10 Specifications

B.10.1 Sample specification from FAO in Aceh - industrial grading

 *Ref 1.2 FAO Tsunami Documents - info note 2.*

Roofing Timber		
Dimension	No. Pieces	Volume (m ³)
5cm x 10cm x 4m	16	0.320
5cm x 5cm x 4m	18	0.180
10cm x 10cm x 2.5m	4	0.100
5cm x 10cm x 2.5m	18	0.225
Allowable species: Ampupu, Bangkirai, Bayur, Berumbung, Bintangur, Bungo, Cemara Laut, Cengal, Kapur, Keruing, Meranti batu, Merawan, Nangka, Resak, Semantok, Sentang, Sungkai, Tanjung.		
Durability Class: Class I-III, under the roof, no ground contact and well ventilated.		
All Timber		
Legality status: Must be purchased from a timber merchant licensed by the Dinas Trade and Industries.		
Treatment Required: Pressure treated CCB with topical application on ends during construction for termite resistance. Must attain hazard class II.		
Grading system / Grade: Local grading system, Class II		
Minimum timber grading standards		
Sloping grain	1 in 8	
Sound knots	1/3 dimension of face, to max of 10cm dia. 1 per meter in length	
Unsound knots or knot holes	1/4 dimension of face, to max of 7cm dia. 1 per 3 meter in length	
Decay (Rot)	None, except in an unsound knot	
Sound sapwood, including wane	1/3 sum of width and thickness	
End splits	Longest split, 15cm at each end	
Stain free from decay	Unlimited	
Twist	1 cm in 3m.	
Compression failures	None	
Brittle heart	1/4 of cross-section at ends	
Open shakes, surface checks, end checks	1/2 thickness	
Seasoning / drying	Timber should be dried to 15% or less	

B.10.2 Sample specification - visual grading of structural timberAdapted from  *Ref 1.2 FAO Tsunami Documents - info note 2.*

Specification	
Kind of defect	Acceptable limits
Sloping grain	1 in 8
Sound knots	1/3 dimension of face, to maximum 10cm diameter. 1 per meter in length.
Unsound knots	1/4 dimension of face, up to maximum of 7cm diameter. 1 per 3 meters in length.
Decay (Rot)	None (except in unsound knot)
Sound sapwood, including wane	1/3 sum of width and thickness
End splits	Longest split, 15cm at each end
Stain free from decay	Unlimited
Twist	1cm in 3 metres
Compression failures	None
Brittle heart	1/4 of cross-section at ends
Open shakes, surface checks and end checks	1/2 of thickness
Seasoning/drying	Timber should be dried to 15% moisture content or less

A - Planning
B - Specification

C - Logistics

C.1	Planning logistics	53
C.2	Reception	54
C.2.1	Local deliveries	54
C.2.2	Imported deliveries	54
C.3	Storage	55
C.4	Transport	57
C.4.1	Transport by truck	57
C.4.2	Transport by other means	57
C.5	Distribution	58
C.5.1	Delivery to construction site	58
C.5.2	Distribution of uncut wood	58
C.6	Health and Safety	59

D - Construction

C.1 Planning logistics

Timber requires special logistic considerations due to its bulk, legal controls, harvesting methods and durability. When managing the supply of timber special consideration may be given to:

- Potentially long lead times
- Phasing of deliveries of timber and other materials (nails, roofing sheets)
- Reception and quality control [C.2]
- Storage and warehousing [C.3]
- Transport [C.4]
- Distribution [C.5]
- Health and safety [C.6]

Lead times

For larger procurements of timber, there are often significant delays in delivery. Lead times for sourcing in different ways vary greatly. Be aware that in some locations or with large orders, timber may not be harvested until the orders for it are made. The suppliers of timber should be checked to see if they are really ready to ship and transport.

Purchasing from multiple sources may be necessary to get the project running from the outset and to ensure suitable quality can be found.

Programme staff and beneficiaries must be made aware of these expected delays.

C.2 Reception

C.2.1 Local deliveries

For large deliveries a professional or a trusted inspection company might be used. For smaller deliveries, grading methods in [B.7 Quality](#) might be used.

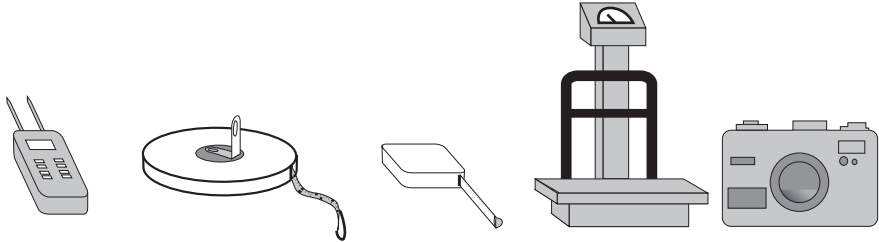

To receive timber and check specifications of timber, you will need: (left to right) moisture meter, measuring tapes, weighing scales. Also take pen, paper and a camera!

Some simple tests on the receipt of timber are:

- Measure moisture content
- Visually check for pests, damp and defects [\[B.7.3 Visual grading: sawn wood\]](#)
- Sight timber along its length to check if it is straight
- Check and photograph certification stamps on timber

Additional dry temporary storage space might be required.

Quality checks of local purchases could be carried out by beneficiary teams.

C.2.2 Imported deliveries

Where timber is being delivered internationally, it may be possible to check (either directly or through a third party validation) at the time of loading. This will help to avoid having to resolve disputes over quality once the timber has been imported.

Agree beforehand any penalties for timber that does not meet quality standards required.

Collective purchasing through a consortium of organisations strengthens the buyers' position.

Prepare transport for loading and storage space beforehand.

Check any specific handling requirements in terms of loading and unloading machinery.

C.3 Storage

Keep timber dry

Timber should be kept dry – dampness is the main reason for it spoiling. Store it on ‘bearers’ to keep it around 30cm from the ground. Store in a clean, dry, well-ventilated building. Particular attention should be paid to the stacking and ventilation of green timber. If no building is available, place the bearers on sand or ashes and cover the timber with a ventilated tarpaulin to protect from rain and sun.



Plywood and other composite boards

Plywood and other composite boards should be stored horizontally, under ventilated covers, with the edges protected and bearers placed every 600mm stretching the width of the sheet to prevent the centre warping and sagging.

Moisture fluctuation

Timber moisture content can and will fluctuate in storage. However, once it is actually to be used in construction it must be within the correct limitations for moisture content. Maintaining the correct moisture content during storage is the best way of making sure that timber will be in the right condition when it is to be used.

Check regularly

As timber and bamboo are perishable items, they should be regularly checked and moved. Checking should include at minimum visual checks and ideally checks with a moisture meter [*B.5 Drying timber*].

Wood storage shed

- *Timber can be stacked vertically*
- *or horizontally if well ventilated*
- *Dry, with timber raised from ground*
- *Eaves for rain protection*

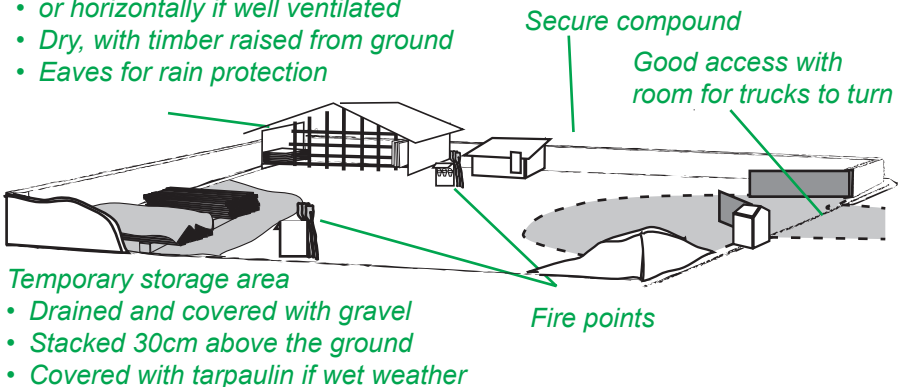

Temporary storage area

- *Drained and covered with gravel*
- *Stacked 30cm above the ground*
- *Covered with tarpaulin if wet weather*

Site

The storage site should well drained and be solid with a slope of less than 2 degrees. The ground should be strong enough for the timber and the delivery trucks.

Stacking

When stacking timber, ensure that stacks are:

- Flat and off the ground on bearers.
- Organised with gaps for access/firebreaks.
- Ventilated, with air gaps within stacks.
- No higher than twice their width in public places or on slopes; or three times their width in a warehouse without lifting machinery.
- Vertical only when storing small quantities.
- Checked after high winds.

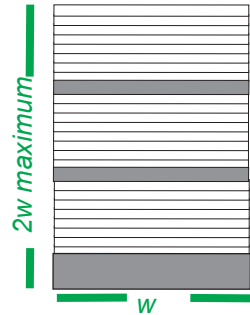

In public places, a timber stack should be no higher than twice its width (w).

Banding

Sawn wood is often bound in packs by metal bands.

Regularly inspect for weakness - in high humidity swelling timber may cause bands to snap. Wear eye protection and gloves when removing bands.

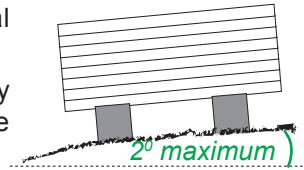

Bearers

Bearers prevent stacks from getting wet on the ground and help with lifting equipment. Bearers should be straight and uniform in size, shorter than the width of the timber to prevent people from climbing the stack and positioned across the stack (not lengthways) to prevent stacks from toppling.

Termites, pests and rot

When storing untreated, or not fully dry timber, a 1:10 solution of borax and water can be sprayed on the ground and walls of the storage area and on the timber. This should be repeated monthly. This can also be done when storing dry timber. Care must be taken during spraying [C.6 Health and Safety].

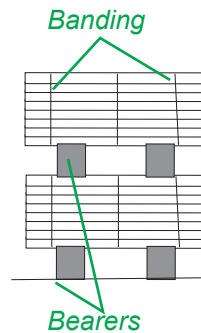

When storing timber that is not completely dry, ensure that the space is well ventilated and mark the affected timbers with stickers or spray paint.

Storage on site



When storing timber on site, timber should be kept off the ground on bearers and covered loosely with a tarpaulin or plastic sheet to keep it dry.

Ensure that any rotten timber is kept well away from other timber.

C.4 Transport

C.4.1 Transport by truck

Trucks should be loaded carefully. The diagrams below show how timber should be laid lengthways along a truck bed rather than across it. This is firstly so that it does not stick out over the sides, but also to reduce the risk of it tipping.

Basic safety in timber transport		
 <p><i>DO NOT stack timber across a truck – it is likely to fall.</i></p>	 <p><i>Timber stacked along truck with sturdy retainers.</i></p>	 <p><i>If loads overhang the truck ensure that they are clearly marked at the end.</i></p>

Loading / unloading

Timber and bamboo are commonly split and damaged in handling. When unloading, staff should be under strict instructions to place the timber rather than to throw it from the truck. Staff should be issued with protective clothing (gloves or boots) to prevent splinters and injuries [\[C.6 Health and Safety\]](#).

**DO NOT
THROW THE
TIMBER FROM
THE TRUCK!!!**

Paperwork

The transportation of timber is frequently tightly controlled. Identify and ensure that the correct paperwork is in place before transporting timber by road. Additionally, insurance may be considered.

Access

Due to timber's volume and weight, large trucks may be necessary. Check that these trucks will be able to navigate the roads leading to delivery sites.

C.4.2 Transport by other means

Floating poles down river

This is a very particular form of transport and is not advised.

By boat

Transport by boat may be required when road transport is too expensive, impractical or dangerous. Shipping of timber should generally be the responsibility of the supplier or a freight company.

C.5 Distribution

Timber can be distributed direct to a construction site or to a distribution point from where beneficiaries can collect it, though it may have to be treated first. Any site poses the challenge of access, and arrangements should be made if trucks are to be used [C.4.1].

Distribution to individuals

When timber or bamboo is being distributed, support will be needed by individuals with transport as timber or bamboo is heavy and bulky.

As timber requires strength and skill to use, additional technical and possibly physical construction support will be needed by individuals to whom it is given.

Distributed timber is unlikely to be used immediately. Beneficiaries should be given advice on how to keep the timber dry. Consider distributing bearers and tarpaulins or plastic sheet.



Wood waste

When significant construction is underway at one site, have a wood-cut waste strategy in place:

- Store: keep wood dry and off the ground;
- Centralise: have a centralised cutting area to make finding usable off-cuts easier;
- Reuse: reuse off-cuts but be careful of the dust and the waste especially if treated.

C.5.1 Delivery to construction site

The delivery of timber should be timed with the delivery of other materials so as not to hold up construction or not to spoil or risk theft before it is used.

When delivered, timber should also be accompanied by fixing materials, tools and people who know how to use them.



C.5.2 Distribution of uncut wood

Where projects involve the use of uncut logs (such as reclaim of fallen trees) or rough timber, cutting tools may need to be provided on site. In many areas these tools might need to be controlled to ensure that they are not used for illegal logging activities.

C.6 Health and Safety

Timber itself is not a health risk (though rare poisonous woods exist) but glues, treatments, inhalation of mould and sawdust and splinters can be harmful.

Dust

Some national health and safety standards give a Maximum Exposure Limit (MEL) for exposure to dust.

If significant amounts of work are taking place indoors, an effective dust extraction system should be installed and protective equipment provided.

Fire safety

Ensure fire safety procedures in warehouses and work rooms are enforced. Be aware that wood dust may present a risk of explosion. Fire-fighting equipment should be available and staff should be trained to use it. Ensure that sufficient firebreaks are present between stacks of timber.

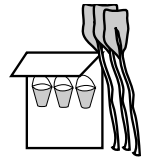

Transporting, loading and moving

Workers must be trained in lifting of heavy weights.

Ensure timber stacks are stable and put up signs to warn against dangers of climbing on stacks.

Gloves should be worn to prevent injury from splinters.



Chemicals

Always follow the advice of the chemical manufacturer. Be aware of the environmental impact of chemicals washed into surface or ground water. If in doubt seek technical advice and do not treat timber yourself.

- Do not use treated wood where it may contact drinking water
- Follow the recommendations of chemical manufacturers, read the MSDS (material safety data sheet)
- Do not distribute timber until chemical treatments are dry
- Do not handle wet, treated timber without gloves
- Wash work clothes separately from household clothing
- Excess treatments should be washed or brushed off
- Wash exposed skin after working with treatments
- Ensure the legality and safety of chemicals purchased
- ensure that work space is well ventilated
- Do not burn treated off-cuts as cooking fuel
- Do not use ash from burnt wood as fertiliser
- Train people in the use of safety equipment and the importance of hand washing and hygiene

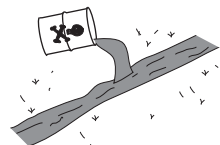

Chemicals may enter water supply.

A - Planning
B - Specification
C - Logistics

D - Construction

D.1	Terminology	63
D.2	Foundations, walls and roof	65
D.2.1	The site	65
D.2.2	Foundations	66
D.2.3	Walls	67
D.2.4	Roof	68
D.3	Connections	70
D.3.1	Making a joint	70
D.3.2	Joining bamboo	71
D.3.3	Nails / screws / washers / bolts	72
D.3.4	Pegs and wedges	73
D.3.5	Wire, string or rope	73
D.3.6	Metal strapping	73
D.3.7	Plates	74
D.4	Termites, pests and rot	75
D.5	Unseasoned timber and coconut	76
D.5.1	Green timber	76
D.5.2	Coconut timber	76
D.6	Poor quality timber	77
D.7	Construction checklist	78

D.1 Terminology

This illustration shows common English names for the components of a timber framed building.

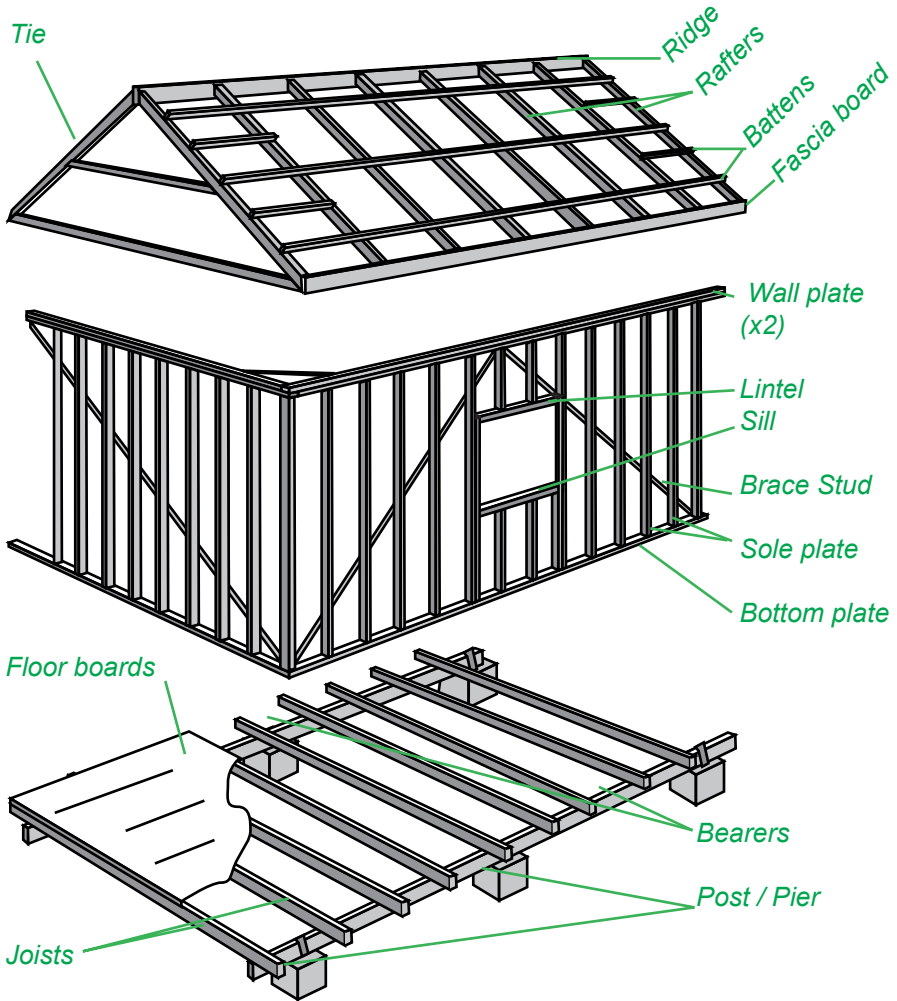

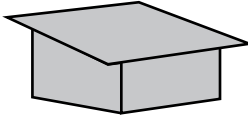

Flat

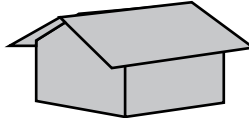

Gable

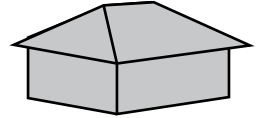

Hipped

Different types of roof. Hipped roofs are stronger and require less material than gabled roofs but can require more skill to build.

The most common types of timber structure are post and beam structures and framed structures. Framed structures lend themselves to fabricating walls on the ground and then lifting them into place.

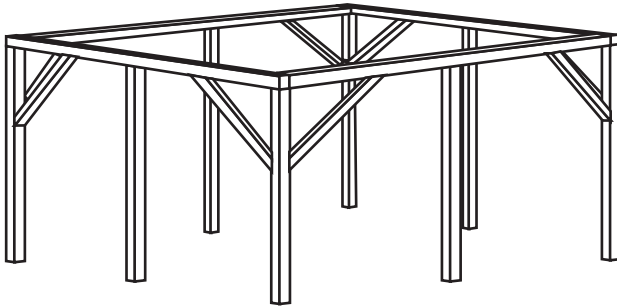

Post and beam

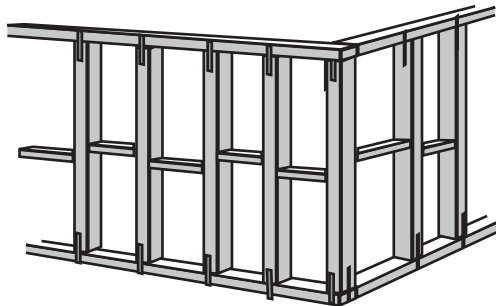

*Framed
Some types of timber structure*

D.2 Foundations, walls and roof

D.2.1 The site

Before constructing, ensure the site is suitable. Ask:

Checking the site

- Have all issues on land ownership been resolved? Has documentary evidence been obtained and signed?
- Does the site have good drainage?
- Has the site been levelled?
- Is the site safe from risks such as subsidence, flooding and landslides?
- Does the site have suitable road access?
- Is there access to essential services such as water supply, work, schools, and health care.

See planning [*A.1 Think before you build*].

D.2.2 Foundations

The point where a building meets the ground is essential for its durability and stability. Because foundations are not visible when a building is complete, monitoring quality is only possible with on-site inspection visits during their construction.

Post foundation

The simplest type of foundation is to sink a timber post straight into the ground. Post foundations are the most pest and rot prone. They also provide termites with access to the rest of the building from the ground. *[D.4 Termites, pests and rot]*

Where they are to be used, post type foundations can be protected using naturally durable species of timber, treatments or design modifications. Treatments for foundation posts should always be completed before use.

Post type foundations should be a minimum of 50cm deep, so allow extra timber for foundation poles.

Connecting walls to foundations

Walls must be securely connected to the foundations! This is true for all types of foundation.

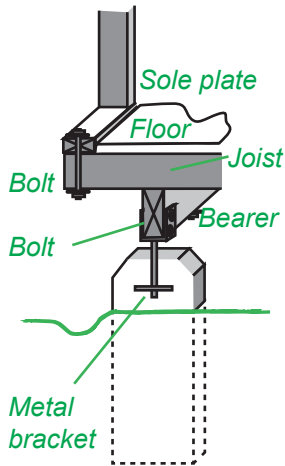

Pad foundation raised floor

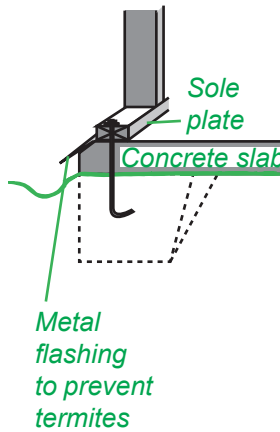

Strip foundation with a concrete slab

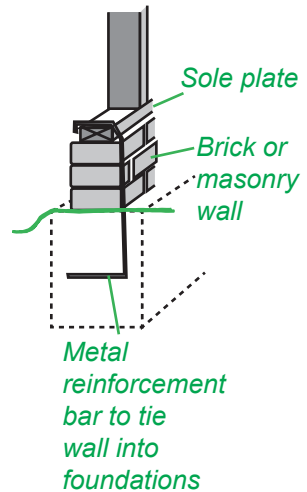

Strip foundation with half height masonry wall and a timber superstructure

D.2.3 Walls

Walls bear vertical loads (roof) and horizontal loads (wind or earthquakes). Check that walls are braced, using diagonal timbers, boards or other infill.



A rectangular structure (such as a wall frame) can deform without bracing

Triangulation: A triangular structure is inherently rigid

By bracing a wall diagonally, triangles are formed, making the wall stronger.



Bracing using diagonal timbers

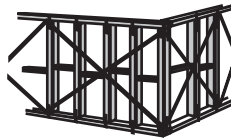

Bracing using metal strap

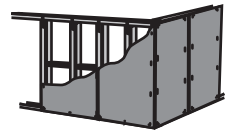

Bracing using structural plywood (minimum 10mm thick)

Examples of bracing walls. Walls should be designed so that the roof can be securely connected to them.



Timber planks side to side will leak as timber contracts



Timber walling designed for shrinkage. The nails are placed to allow the timber to shrink and move. They are also placed close to the timber below to hold it in place



Examples of timber wall cladding. As they are exposed to damp, they must be designed for shrinkage and expansion.

D.2.4 Roof

Roof frames must bear the weight of the roofing material, wind load (or lift), the weight of people to repair them, and in some cases snow loads.

In many structures the roof frame can be the single greatest consumer of timber. Bamboo, coconut timber or other alternatives can replace rafters and roofing battens.

Span tables

Span tables are used to define the maximum allowable joist and rafter spans for a given timber type, dimension and building type. Span tables for a variety of timber types are given in [Ref 8.13 Roof Structure Guide](#) or in [Ref 8.4 The Solomon Islands homebuilding manual](#).

Tie roofs down

When inspecting a roof, ensure that every component is tied down to the building walls or frame. For example, ensure that the battens are securely tied down to the rafters and the rafters are secured to the wall plate.

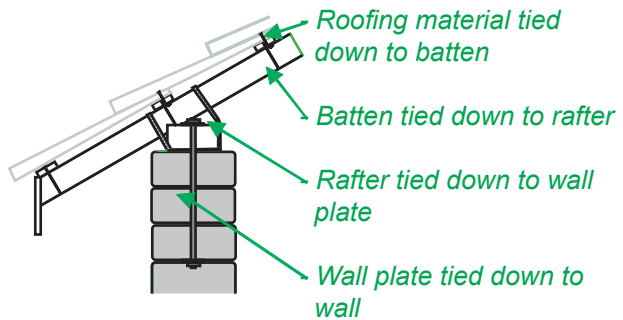

Ensure that roofs have overhangs

Ensure that roofs have significant overhangs to protect the walls. Their pitch should be designed appropriate to the wind load expected as well as the materials available for the covering.

A pitch of around 30 degrees is a common angle for a roof, allowing water to run off but reducing lift in high winds. However in some locations (often with low rainfall) flat roofs are more common, whilst in some areas (often with snowfall) very steep roofs are more common.

[Ref 10.4 Guidelines for the Storage and Erection of Trussed Rafters on Site](#).

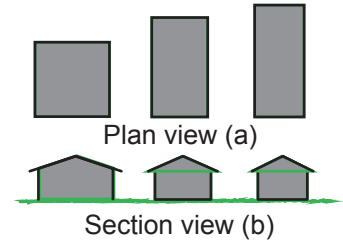

For the same covered area, a square building will have a wider roof span than a rectangular building, and so will need longer timbers.

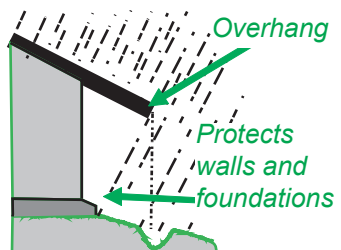

Use of an overhang to protect walls and foundations from rain.

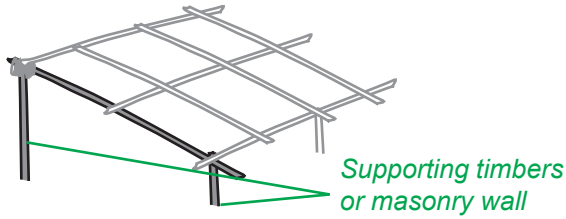

Mono pitch or lean to type roof.

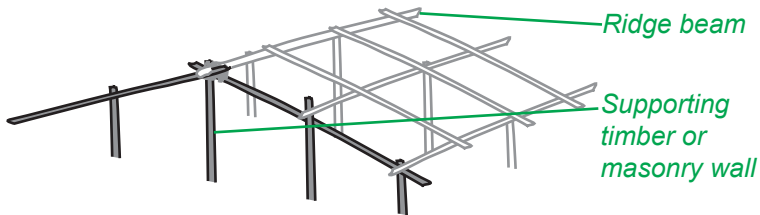

Roof with ridge beam. The ridge beam is supported by posts, and the rafters are supported by the ridge beam.

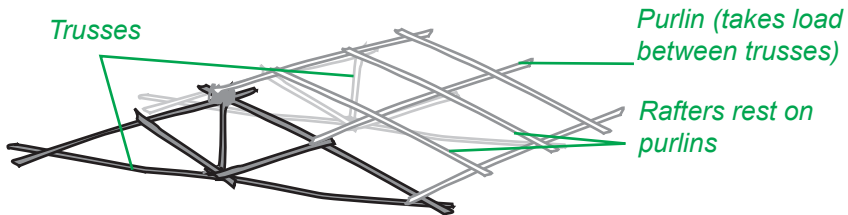

Simple truss. Trusses are triangulated timber structures. Horizontal purlins span the gap between the trusses.

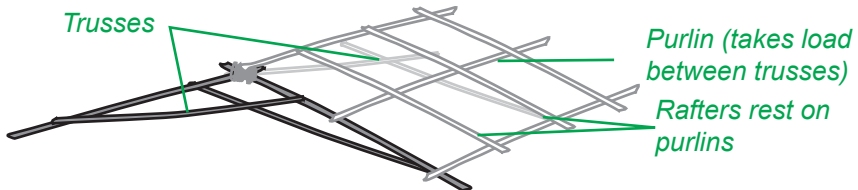

Scissor truss. Another type of truss that forms a rigid structure. As with the simple truss, horizontal purlins span between the trusses

D.3 Connections

For simple construction, timber is most commonly jointed with nails, pegs, screws or bolts. Joints can be strengthened with metal strapping or gang plates (metal plates nailed either side of a joint to provide strength).

Check that timber joints are built so that the building forces push them together rather than pull them apart.

 *Ref 8.13 Roof Structure Guide* for more on jointing and timber structure detailing.

D.3.1 Making a joint

Most joints are weak unless triangulated.

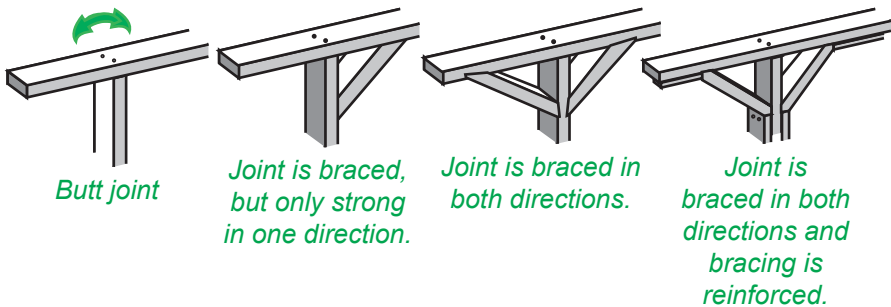

Strengthening a simple joint by triangulation (this is known as bracing).

Cutting timber can increase the contact surface area between pieces of timber and make a stronger joint. Choice of joint will depend upon the skills of the carpenters, the direction of the stresses and the fixings that will be used.

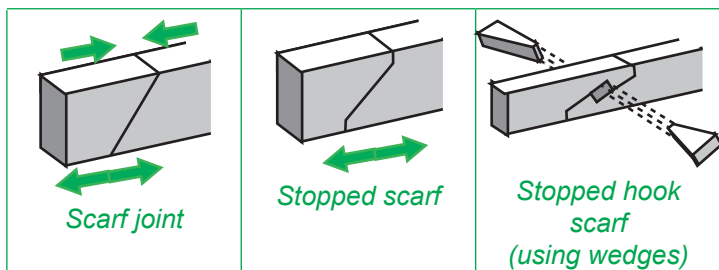

Compression	x	✓	✓
Tension	x	x	✓

Behaviour of some timber joints under compression and tension.

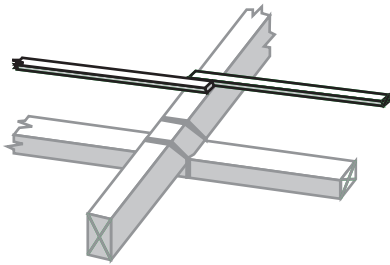

Battens end on the rafter. The joint is weaker and the battens risk splitting where they are nailed

When two pieces of timber are joined end on, the joint is stronger if the timber continues past the joint.

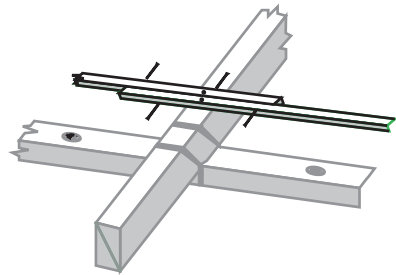

Battens continue beyond the rafter. This is stronger and they are less likely to split

D.3.2 Joining bamboo

Unlike timber, bamboo has hollow sections. When joining bamboo, the challenge is to avoid crushing these hollow sections.

Bamboo poles can be bolted, pegged, tied, wired, screwed, filled and then bolted together. Sometimes they can be nailed but great care must be taken not to split the bamboo. The method used will largely depend on local skills.

Joining bamboo: local skills and techniques

The design of joints for bamboo should consider the existing skills and construction techniques of the affected community. As there are massive variations between species of bamboo and their properties, techniques evolve regionally. These techniques are often based on a range of factors that may not be apparent at first glance.

Assess locally built structures, and identify what worked and what did not work. Promoting best practices and clarifying what was bad practice, will have the greatest long term effect.

In bamboo construction, check that elements continue past the joint to the next node and then a few centimetres further. This will provide the greatest strength.

📖 [Ref 8.10 Building with Bamboo](#) and 📖 [Ref 7.1 www.humanitarianbamboo.org](#) for more on bamboo detailing.

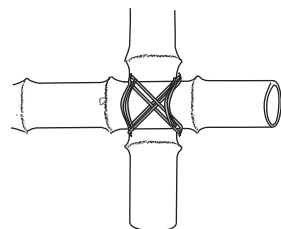
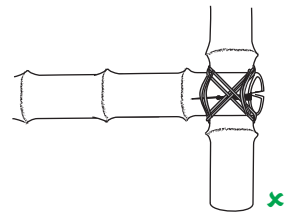

Bamboo will split if the poles do not continue past the next node after a joint

D.3.3 Nails / screws / washers / bolts

Nails only hold timbers in place. Joints should be designed so that the timber carries the loads of the building and not the nails.

Do not procure nails that are too thick as they will split the timber. If using thicker nails, check that people have tools to drill holes before nailing. Drill bits should be around 10% smaller than the nail shank.

Properly sized screws or bolts are stronger than nails. They also allow the timber to be recycled but are slower and require drills and screwdrivers or spanners.

Wood treated with copper-based preservatives [B.6 Treatments], can corrode fixings (nails, screws, bolts, brackets). To minimise corrosion fixings can be made from galvanised steel, copper or stainless steel, although these will be much more expensive than standard fixings.

 *Ref 8.5 Timber Joint Design 2 – Nails, Staples and Screws*

Bolts

Bolts need washers! Washers prevent the head of the bolt from sinking into the timber.

 *Ref 8.6 Timber Joint Design 3 – Bolts, Coach Screws and Timber Connectors*

Tooth ring connectors

Tooth ring connectors are washers with sharp "teeth" that can help to create stronger joints. However they can be relatively expensive, are less commonly available, and are not a good substitute for training people to regularly tighten bolts.

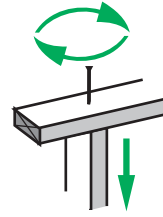

A single nail can easily pull out and the joint can twist.

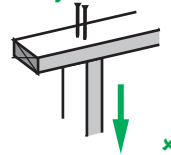

Parallel nails can pull out.



Angled (skewed or tosh) nails are strongest.

Two nails for 100mmx50mm timbers should be sufficient.

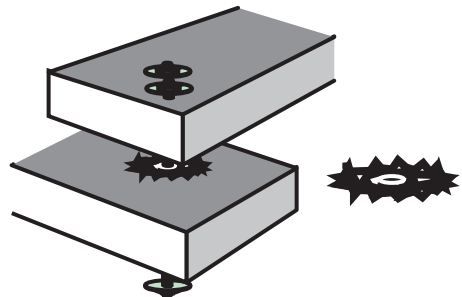

✓ When using bolts, always use washers! They help to prevent the bolt from sinking into the timber.

✓ Tooth ring connectors can also be used with bolts, but can be expensive and difficult to find.

D.3.4 Pegs and wedges

The use of pegs or wedges is most common in highly corrosive environments such as the seaside. It is also very common in bamboo construction.

Pegs or wedges should only be used if the local carpenters have the skills to build with them. Check that the geometry of the joint holds the load and not the pegs.

Pegs should be made from timber such as seasoned hardwood that will not swell or shrink. They should be positioned so that gravity will tighten them and not loosen them over time.

D.3.5 Wire, string or rope

Binding timber (especially poles) with heavy duty galvanised fencing wire or rope is a very common way of joining pieces of timber. A wire lacing tool will help to make strong joints (commonly use 2-5mm wire).

Check that lashings are as tight as possible. Each turn should be tightened as it is made. “Frapping” turns should be wrapped around the binding to further tighten the lashing.

In many cases when using natural fibres, wetting the fibres prior to binding will allow them to dry in a tighter and hence stronger configuration. Protect bindings from exposure to excessive rain or sunshine so that they last longer. Specifications for rope can be found in [Ref 5.3 Plastic sheeting. A guide to the specification and use of plastic sheeting in humanitarian relief.](#)

D.3.6 Metal strapping

Metal straps are a simple way to strengthen nailed joints. A distribution of rolls of metal strapping in an earthquake zone would be a quick and simple way to improve timber buildings. If strapping is not available with pre-drilled holes, many sheet metal suppliers can cut rolls of strapping.

Metal straps should be fixed with short galvanised nails with wide heads and high shear strength.

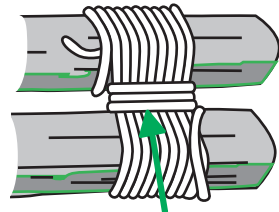

Frapping turns wound on after the main binding to tighten the joint.

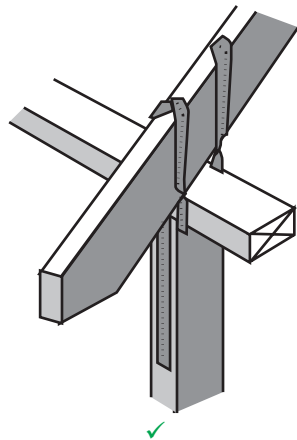

A roof tied down with a metal strap.

D.3.7 Plates

Joints are often strengthened by "fish plates" - timber or metal plates nailed across the joint. **They should not be used when** the timber has bending forces upon it. They are commonly made with off-cuts of timber, but care must be taken to ensure that the timber off-cuts are long enough and do not split.

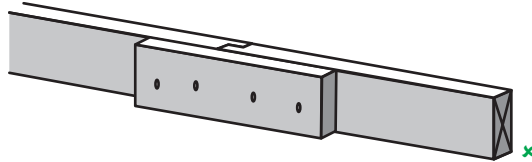

Poorly joined timber - the wooden plate is too short and is poorly nailed - it is likely to split.

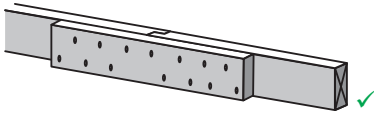

One nailed plate - the wooden plate is at least five times as long as it is tall. The nails are evenly distributed and enter at least 3/4 of the way into the timber being joined.

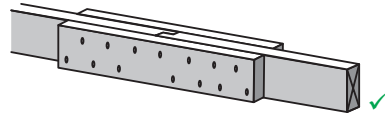

Two nailed plates - this is roughly twice the strength of a single nailed fish plate.

Timbers should not be joined by nailing a plate across them when there is a bending force on the timber.

Specialised metal plates with bolts can be used as joints, although they may be costly and difficult to procure.

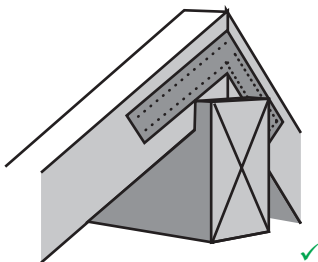

Roofing detail showing the use of a metal plate

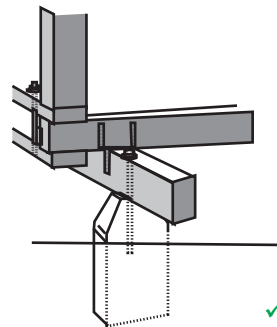

Foundation detail showing the use of both metal plates and metal straps

D.4 Termites, pests and rot

The best way to control termites, boring insects and fungal rot is by designing to keep the timber in buildings dry, well ventilated and away from the ground.

Building out termites and pests

- ✓ Design buildings to KEEP TIMBER DRY. The key is in the detailing.
- ✓ Ensure good drainage of surface water surrounding the building.
- ✓ Avoid the use of timber in areas that may get wet such as bathrooms. Provide a clear barrier between timbers and nearest water supply.
- ✓ Ensure a separation between timbers and the ground so that termites find it difficult to travel from underground nest sites into the timber.
- ✓ Train communities to reduce termite friendly habitats, by clearing fallen timber and storing timber such as firewood away from buildings.
- ✓ Clean up all timber construction waste.
- ✓ Where possible select timber types that are less susceptible to attack or decay, especially those in contact with the ground or moisture.

Treating timber

If timber must be in contact with the ground, it should be treated by beforehand. If there is no other option, use a mix of 1:2 waste engine oil and diesel. Although some timber may be pretreated, on-site dipping or painting treatments should take place after joinery work is complete as termites will bore through freshly cut timber at the joints.  [Ref 8.8 Timber Pole Construction](#)

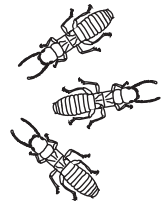

Treatment of infested timber

Termite extermination using arsenic trioxide powder is to be discouraged on safety grounds unless skilled professionals in termite control are available.

For infestations of boring insects, surface spraying or injection into the emergence holes can be considered. Fumigation is normally only successful when conducted in controlled environments on furniture.

Timber joined to foundation by metal fixings

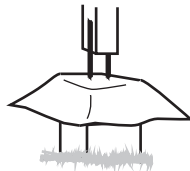

Metal cowl (from hammered sheet metal) over foundation prevents termites from climbing and allows termite tunnels to be easily removed.

Example: Separating timber from the ground using “Ant caps” – metal plates that force termites to build visible earth tunnels to access the timber. People should be encouraged to regularly inspect and clean these plates.

 [Ref 8.14 Building out Termites](#)

D.5 Unseasoned timber and coconut

D.5.1 Green timber

Unseasoned timber is known as green timber. Building with green timber is extremely common throughout the world.

All timber shrinks and swells, warps and twists as it gains or loses moisture. Wherever possible timber should be seasoned [*B.5.1 Reducing moisture content: drying wood*] before use.

The wetness of green timber at the time of construction may make it more prone to pest infestation and rot [*B.4 Durability*], so care should be taken with storage at construction sites. Green timber should not be used for building components such as windows and doors.

Green timber should be oversized as it is generally ungraded. [*B.7.1 Grading classification*]

We have always built with timber like this - but it is not good for windows or doors.

When building with green timber, ensure that the contraction and movement of the timber has been taken into account.

D.5.2 Coconut timber

Generally coconut timber has lower overall strength and durability than other timbers of similar density. However it can be very suitable for use in temporary structures, or in permanent structures if they are carefully designed.

The large size of coconut poles makes them suitable for large structures such as temporary bridges.

Building with coconut timber

- ☑ Wherever possible, coconut poles should be completely above ground, with clear termite prevention [*D.4 Termites, pests and rot*] strategies.
- ☑ Coconut timber structures should be especially well braced.
- ☑ Coconut timber should be selected and marked according to its anticipated use. The strongest timber is to be found nearer the bottom of the palm. Coconut logs are often hollow, and softer towards the middle.
- ☑ As with poor quality timber [*D.6 Poor quality timber*], structural elements should be prioritised and softer wood used for less critical components such as roofing battens.
- ☑ Allow additional overlapping at joints because the ends of coconut timber tend to be weaker than other types of timber.
- ☑ Cutting the face of the coconut pole, for example to join another timber, will significantly reduce the strength of the pole.

📖 *Ref 7.5 Coconut Palm Stem Processing Technical Handbook* provides an overview of coconut timber.

D.6 Poor quality timber

Often some or all of the available timber will be of poor quality. With poor quality timber extra care will be required to use the timber effectively and safely. Some of the tips below may help.

Sort the timbers

- ✓ Ensure that sections with large knots or splits are cut out or patched to stronger sections of materials.
- ✓ Mark the lowest grade timbers to ensure they are not accidentally used.

Design for the timber available

- ✓ Over-size, or over-design, those elements that are critical to the structure of the building if they are to be built with timber of uncertain quality.
- ✓ Ensure that spacing and spans between elements are low.
- ✓ Where only lower quality timber is available, upgrade the cross sections.

Finding the most important building elements

- ✓ Know which elements of your building take the highest forces. These elements, such as beams, lintels and purlins require the best timber. Remember in general construction, horizontal elements such as floor joists, top plates and structural beams are commonly much closer to their design limitation than vertical elements such as studs.

Working with weaker timbers

- ✓ Know which building components are subject to lower forces. Examples of these components are roofing battens, timber cladding and flooring for storage in roof cavities.
- ✓ Short lengths of timber can always be used to brace joints.
- ✓ Always sight along timbers. If they are not straight then they should be used with the bow upwards so that loads will tend to straighten them.
- ✓ Remember to over-order. Usually order 10% more timber than required. In the case of only poor quality timber being available it may be necessary to order 20% more timber than required.
- ✓ If in doubt, do not use poor quality timber for a priority application.

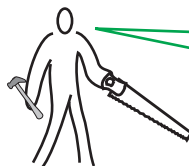

Use as a filler

- ✓ As a last resort, poor-quality timber can be used for non-structural purposes such as wattle-and-daub, fencing, furniture etc.

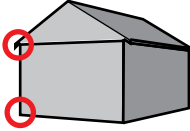
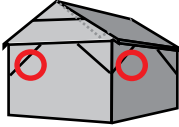

This timber is of very poor quality, but we can still use it if we are careful.

D.7 Construction checklist

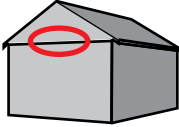
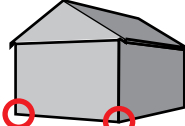
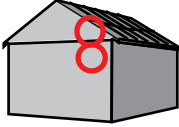
Preventing common causes of timber building collapse	
	<p>Buildings should be tied down</p> <ul style="list-style-type: none"> ✓ The roofing material must be securely connected to the roof. ✓ The battens should be securely connected to the rafters. ✓ The rafters should be securely connected to the wall plate. ✓ The wall plate should be securely connected to the wall. ✓ The wall should be securely connected to the foundations...
	<p>Buildings should be braced [D.2.3]</p> <ul style="list-style-type: none"> ✓ Walls should be braced diagonally. ✓ Roofs should be internally braced.
	<p>Timber should be sized appropriately [D.6]</p> <ul style="list-style-type: none"> ✓ Know which elements of a building take the highest forces, and size timbers appropriately. ✓ Structurally critical building elements should be over designed if timber of uncertain quality is to be used.
	<p>Avoid excessive spans [D.2.4]</p> <ul style="list-style-type: none"> ✓ Ensure that the distance between supports for timbers is at a minimum.
	<p>Foundations must be solid [D.2.2]</p> <ul style="list-style-type: none"> ✓ Foundations must be on well prepared ground. ✓ Foundations must be sufficiently deep. ✓ Foundations must be protected from moisture and insect attack.
	<p>Roof must be secure [D.2.4]</p> <ul style="list-style-type: none"> ✓ Roof must be properly connected to the walls to prevent it from lifting. (All roof components must be securely tied down to the walls.) ✓ Timbers must be sized appropriately. ✓ Structure and trusses must be carefully designed.

A - Planning

B - Specification

C - Logistics

D - Construction

Annexes

ii.1	Glossary	80
ii.2	Further references	86

ii.1 Glossary

Term	Meaning
Bamboo	A woody plant of the grass family. Can be clump-type (growing in patches) or running-type (spread out).
Batten	Timbers to which the covering materials are fixed.
Beam	Structural member which supports a load due to its internal resistance to bending.
Bearer	1) A beam below the floor to support floor joists. 2) Supports to keep stacks of timber off the ground.
Board	a) A piece of timber which is wider than it is thick. b) Shorthand for a sheet of composite timber.
Boucherie	A sap-displacement treatment method.
Bow	Curving along a board, resulting in a bridge shape.
Brace	Secondary structural member that provides stability to other members, often by completing a triangle.
Butt	The thicker end of a pole.
Cellulose	Complex sugar-based chemicals in a tree providing strength and elasticity to timber.
Certification	Awarding of an independently verified certificate of legality in terms of CITES protection and forest management.
Chain of custody	Process through which wood passes from tree to finished wood product and can be traced back to its origin through inspection.
Check	Separation of fibres along the grain and across the growth rings. The crack formed does not run from face to face.
CITES	Convention on International Trade in Endangered Species of Wild Flora and Fauna (www.cites.org)
Composites	Timber that has been reformed and glued to make various products including plywood and other boards.
Compression failure	Fracture of wood fibres across the grain resulting from compression along the grain (being squeezed).
Crook	Deviation of a timber pole from a straight axis involving more than one bend.
Culm	Stem of a bamboo plant, equivalent of the trunk of a tree.
Cup	A concave curvature across the grain or width of a piece of timber.
De-barked	See pole.

Decay	See rot.
Deforestation	The permanent clearing of forestland.
Degradation	The result of a process that reduces the value of wood (see rot and weathering).
Density	The total mass of wood and moisture in a piece of timber in kilograms per cubic metre. As moisture content can change, density is often expressed at a specified moisture content, usually 12%.
Durability class	Classification determined by how many years timber will last above ground with and without treatment (seasoned or natural durability) at a constant moisture content.
Drying	See seasoning.
Edge	The surface of a board on the longest side.
End	The surface of a board on the shortest side.
Envelope treatment	Treatment that is painted on to timber or bamboo, penetrating just below the surface and not all the way through.
Face	The surface of the board covering the greatest area.
Fasteners / fixings	Bolts, nails, screws, pegs used for joining timber or bamboo to itself or other materials.
Fibreboard	A type of composite in sheet form.
Figure	The markings on the surface of sawn timber formed by the structural features of the wood.
Finished	Sawn timber that has been planed to make its surfaces smoother.
Frame	The main timbers of a structure fitted and joined together.
Fungi	See rot.
Grading, industrial and visual	The designation of the quality of a piece of timber or other manufactured wood products in accordance with standard rules that vary from country to country. Grading systems are normally combinations of machine (industrial) and visual grading.
Grain	Direction of the wood fibres relative to the main length axis of the timber.
Grain, sloping	Deviation of grain from being parallel to the longitudinal axis of a board.
Green timber	Timber that is freshly cut or has not been seasoned (dried).

Hardwood	A general term for timber of broad-leaf trees. The term is not related to the hardness of the wood.
Harvesting	Cutting and collection of trees (felling or forestry) and bamboo.
Hazard class (Use class, Risk class)	The classification of timber by what risk it will be exposed to – e.g. whether it is to be used internally or externally or if it will be in contact with the ground or not.
Heartwood	The centre of a tree, darker in colour, providing the structural strength.
Knot	Remains of a branch embedded in the tree trunk which appears as a dark round circular shape on timber board.
Joints, jointing	A connection for joining pieces of wood.
Joinery	Finished timber fixtures such as doors and windows.
Joists	Timber beams used to support floor boards or ceilings.
Knot, sound/ unsound	A solid knot that is as hard as the surrounding wood, and shows no sign of decay. An unsound knot is decayed
LCA / Life Cycle Analysis	A way to determine a product's impact on the environment through the entire life cycle of its manufacture, transport, and disposal. More information from: http://www.unep.fr/pc/pc/tools/lca.htm
Leaching	The leaking of treatments out of timber into water.
Legality	Legality of timber is nationally defined but framed by international agreements such as CITES. The legality of timber is confirmed by its certification.
Lignin	Bonding agent in the cellular structure of timber.
Lintel	A horizontal beam spanning a door or window which may or may not provide structural support.
Lumber	American term for timber.
Milling	The processing of timber by sawing.
Moisture Content (MC)	Weight of moisture in timber expressed as a percentage of its oven-dry weight.
Mould	Fungal growth on or near the surface of the wood, not normally causing significant discolouring.
Name, Latin / common	See species.
Penetration class	The classification of treatments by how far they will penetrate timber. Note the penetration properties of timber vary between species.

Pest	Organism that attacks wood. Usually only insects are described as 'pests', but sometimes the term includes fungi.
Pesticide	A treatment specifically aimed at protecting timber from biological attack.
Plywood	See composites.
Pole, peeled / rounded	Timber poles are un-sawn logs. Rounded or peeled poles are poles with the bark removed, stripped to a regular size. Also known as ROUND TIMBER.
Preservative	See treatment.
Primary wood	Timber from slow-growing forests, usually hardwood.
Processing	The transformation of logs to timber products, including sawing, planing and treating.
Purlin	Horizontal framing timbers supporting rafters or spanning trusses that support the roof.
Rafter	Part of the frame work of a pitched roof - one of the sloping timbers that support battens and roofing materials.
Rapid environmental assessment (REA)	A process to collect, analyse and review information on environmental impacts, in order to reduce the potential negative environmental impacts of emergency assistance. More from: http://www.benfieldhrc.org/rea_index.htm
Reclaimed, recycled	Timber that has already been in use in a structure and can be reused. See salvaging.
Reduced impact logging (RIL)	A sustainable forestry management approach that includes selection of individual crop trees, and ensuring that other trees are not damaged by creating precise access to crop trees, and using appropriate felling techniques.
Resistance, natural	See durability class.
Rings, growth/ annual	The rings marking the growth of the tree seen in a transverse tree section.
Risk class	See hazard class.
Rot	The decomposition of wood by fungi, organisms that dissolve materials out of the cell walls of wood.
Rough (sawn)	Sawn timber that has not been planed to make surfaces smoother.
Salvaging	The collection and use of trees that have been felled during a disaster for timber or the collection of timber members from damaged or unused buildings.

Sapwood	Wood surrounding the heartwood. It contains the living cells and is lighter in colour and more penetrable and vulnerable to insect attack and rot than heartwood.
Seasoning	Drying of wood, by stacking and allowing it to dry in the air (unforced) or drying in an oven or solar dryer (forced), to reduce moisture content and improve durability.
Seismic risk	Construction in areas prone to earthquakes requires special techniques to make timber buildings safe.
Shake	Fracture of the wood fibres between the growth rings caused by factors other than shrinkage.
Shrinkage	Linear shrinkage is caused by reduction of moisture content below fibre saturation point and expressed as a percentage of the original dimensions or volume of timber.
Softwood	Commercial timbers of this group are nearly all conifers. The term has no reference to the relative hardness of the wood.
Spacers	Small bits of wood used to create space between stored or drying timbers to ensure they are ventilated. Also known as bearers.
Span tables	Standard tables containing allowable joist and rafter spans for given timber type, dimension and building type.
Species	Tree and bamboo species have two names. The common name varies around the world while the Latin, or botanical, name is universally accepted.
Spiral	A pole that has twisted.
Splits	Splits are cracks (fractures) that extend through a piece.
Spring	A longitudinal curvature of the edge of a piece of timber, not affecting the face, making an arch.
Stacking	Storing timber in layers separated by spacers.
Stain	a) A chemical product to colour wood (often included in treatments to show which timbers have been treated) b) Discolouration of timber by fungi
Strength	The ability of a member to sustain stress without failure.
Stress grade	Classification of timber's ability to bear stress without breaking/weakening based on its species, the part of the tree it is cut from and its quality.
Stud	Vertical framing timbers used as a supporting element in a wall or partition.

Sustainable timber	Timber from forests that are managed in such a way to ensure that they are replanted.
Sweep	Deviation of a timber pole from a straight axis with one bend (like a banana).
Swelling	An increase in wood dimensions as moisture content rises.
Taper	The thinning of a pole or bamboo towards one end.
Tension	The force of pulling or stretching.
Termite	Whitish ant-like social insect that feeds on wood.
Thinning	The process of cutting branches from trees or selectively cutting bamboo to encourage growth.
Timber	The wood of trees cut and prepared for use as building material (also known as lumber).
Treatment	A chemical used to increase the durability of timber or bamboo. It can be applied through pressure, soaking or brushing, spraying and dipping.
Trunk	The main body of a tree.
Truss	A frame made of timber members connected to form triangles and usually used for roofs.
Twist	Spiral distortion along the length of a piece of timber.
Use class	See hazard class.
Wane	The absence of wood on any face or edge of a piece of timber due to the board being cut too near to the edge of a log.
Want	The absence of wood due to some of the timber being split off in processing.
Warp	Variation of a surface from a straight axis. It includes bow, spring, cup and twist and may be due to irregular seasoning.
Weathering	Deterioration of timber due to actions of the weather e.g. sunlight and rain.
Wetting	The process of timber being exposed to water, usually rain.

This glossary is adapted from: <http://oak.arch.utas.edu.au>.

ii.2 Further references

Note that web addresses often change - if an address no longer works, then do an internet search for the document and publisher.

See www.humanitarian timber.org for many more timber-related resources

Most of the hard copy books can be found at www.developmentbookshop.com.

REF 1 KEY REFERENCES

- Ref 1.1* Wood Handbook: (Wood as an Engineering Material) *Comprehensive 500-page manual*. U.S. Department of Agriculture, Forest Service, Forest Products Laboratory, 1999, www.fpl.fs.fed.us
- Ref 1.2* FAO Tsunami Documents: *Info Note 1 covers procurement, Info Note 2 covers usage*. www.fao.org/forestry/27219
- Ref 1.3* Timber Design for Durability: *Information on how to make timber last*. National Association of Forest Industries, 2003, www.timber.org.au

REF 2 STRATEGIC PLANNING AND ASSESSMENT

- Ref 2.1* Sphere: (Humanitarian Charter and Minimum Standards in Disaster Response) *Guidance notes for shelter must be read carefully*. The Sphere Project, 2004, www.sphereproject.org
- Ref 2.2* Transitional Settlement; Displaced Populations: *Detailed advice on planning coordinated shelter and settlement programs*. Corsellis and Vitale, 2005, Oxfam/shelterproject, www.sheltercentre.org
- Ref 2.3* Transitional Settlement and Reconstruction after Natural Disasters: *Detailed advice on planning coordinated shelter and settlement programs*. 2008, UN/OCHA, www.sheltercentre.org
- Ref 2.4* Camp Management Toolkit: *Guidance for providing assistance in camp settings with sections on planning and assessment*. NRC, 2008, www.nrc.no/camp
- Ref 2.5* UNHCR Handbook for Emergencies: UNHCR, 2007, www.unhcr.org
- Ref 2.6* Practitioners' Guide to the Household Economy Approach: *Tools for making a market analysis. See Market Assessment (Annex C)*, FEG Consulting and Save the Children UK, 2008, www.savethechildren.org.uk

- Ref 2.7* Emergency Market Mapping Analysis (EMMA): *Tool for rapid assessment of markets to assist in project planning*. See www.oxfam.org.uk for updated details.
- Ref 2.8* FAO Forestry Contacts Database: *List of government forestry departments with contact details*. www.fao.org
- REF 3 ENVIRONMENT
- Ref 3.1* Life Cycle Initiative: *Still in early phase of development*. <http://lifecycleinitiative.unep.fr>
- Ref 3.2* UNHCR Environmental Guidelines: UNHCR, 2005, www.unhcr.org
- Ref 3.3* Guidelines for Rapid Environmental Assessment in Emergencies: *How to use the REA tool*. www.benfieldhrc.org
- Ref 3.4* Cooking Options in Refugee Situations: *Fuel efficient stoves to reduce firewood consumption*. UNHCR, 2002, www.unhcr.org
- Ref 3.5* Reduced Impact Logging in Tropical Forests: FAO, 2004, www.fao.org
- Ref 3.6* Revised ITTO Criteria and Indicators for the Sustainable Management of Tropical Forests: *For large-scale reconstruction and development projects*. ITTO, 2005, www.itto.or.jp
- Ref 3.7* CIFOR Adaptive Collaborative Management Program: *Resource management tools*. www.cifor.cgiar.org/acm/methods
- Ref 3.8* Destitution, distortion and deforestation: *Detailed economic and political study on the impact of conflict on the timber and woodfuel trade in Darfur and the role of humanitarian organisations*. UNEP, 2008, www.unep.org
- REF 4 LEGALITY AND CERTIFICATION
- Ref 4.1* Keep it Legal: Best Practices for Keeping Illegally Harvested Timber Out of Your Supply Chain, WWF, 2006, www.panda.org
- Ref 4.2* CITES and the Wood Products Trade - What You Should Know: UNEP, www.fws.gov/international/
- Ref 4.3* Central Point of Expertise on Timber (CPET): *Checklist and tools for verifying timber*. www.proforest.net/cpet
- Ref 4.4* Sourcing Legal Timber from Indonesia: UK Timber Trade Federation Scoping Study, 2004, www.illegal-logging.info

- REF 5 SPECIFICATION
- Ref 5.1* Timber Usage for Tsunami Reconstruction in Indonesia: (Information Note 2), www.fao.org/forestry
- Ref 5.2* Wood for Good Construction Fact Sheet, www.woodforgood.com
- Ref 5.3* Plastic sheeting. A guide to the specification and use of plastic sheeting in humanitarian relief: IFRC, Oxfam, 2007. www.plastic-sheeting.org
- REF 6 SPECIES
- Ref 6.1* Tropical Timbers of the World: U.S. Department of Agriculture, Forest Service, Forest Products Laboratory www.fpl.fs.fed.us/
- Ref 6.2* TRADA Timber species database: www.trada.co.uk/techinfo/tsg/
- Ref 6.3* Timber species summary reports: www.timber.net.au/documents/
- Ref 6.4* Timber Species and Properties: National Association of Forest Industries, 2004, www.timber.org.au
- Ref 6.5* Species selector: *Help identifying protected and 'nearly vulnerable' tree species*. www.foe.co.uk
- REF 7 BAMBOO AND PALM
- Ref 7.1* www.humanitarianbamboo.org
- Ref 7.2* Vertical Soak Diffusion handbook: www.bamboocentral.org
- Ref 7.3* Bamboo common and latin names in multiple languages: www.plantnames.unimelb.edu.au
- Ref 7.4* Bamboo As A Building Material: RWTH Aachen University: <http://bambus.rwth-aachen.de/>
- Ref 7.5* Coconut Palm Stem Processing Technical Handbook: GTZ, 1996, www.fao.org/documents/
- Ref 7.6* Palm tree species: www.trebrown.com/palms_arecaceae.php
- REF 8 USE (DESIGN AND ENGINEERING)
- Ref 8.1* National Information Center of Earthquake Engineering: *Comprehensive design information for timber frame buildings*. www.nicee.org/IAEE_English.php

- Ref 8.2* After the Tsunami - Sustainable Building Guidelines: UNEP & SKAT, 2007, www.unep.fr
- Ref 8.3* Basic Construction Training Manual for Trainers: *Can be used as a basis for providing technical support to beneficiaries.* Heini Müller, 2004, www.redcross.ch
- Ref 8.4* The Solomon Islands homebuilding manual, Ayykar K, 1990. *Construction and design manual for cyclone risk areas. Includes span tables and technical detailing.* <http://www.humanitarian-timber.org/node/172>
- Ref 8.5* Timber Joint Design 2 – Nails, Staples and Screws: Timber Data Files Series, 2001, www.timber.org.au
- Ref 8.6* Timber Joint Design 3 – Bolts, Coach Screws and Timber Connectors: Timber Data Files Series, 2001, www.timber.org.au
- Ref 8.7* Architectural Timber Trusses: Timber Manual Data File SS7, NAFI, 2005, www.timber.org.au

The following are hard-copy only:

- Ref 8.8* Timber Pole Construction: Follett & Jayanetti (2000), ITDG
- Ref 8.9* Technical principles of building for safety: Coburn, Hughes, Pomonis, Spence, 1995, ITDG
- Ref 8.10* Building with Bamboo: Janssen, 1995, ITDG
- Ref 8.11* Appropriate Building Materials: Mukerji and Stulz (1993)
- Ref 8.12* Engineering in Emergencies: Lambert and Davies (2003)
- Ref 8.13* Roof Structure Guide: SKAT (TK 24), <http://www.skat.ch/>
- Ref 8.14* Building out Termites: An Australian manual for environmentally responsible control: *Contains information on design to avoid and treat termite infestation.* Robert Verkerk, 1990, Southwood Press
- Ref 8.15* Barefoot architect: A handbook for green building, Johan van Iengen, 2008, Shelter publications.
- REF 9 TREATMENTS AND DRYING
- Ref 9.1* Dry Kiln Operator's Manual: U.S. Department of Agriculture, Forest Service, Forest Products Laboratory, 1991 www.fpl.fs.fed.us/

- Ref 9.2* Air-drying of lumber: U.S. Department of Agriculture, Forest Service, Forest Products Laboratory, 1999, www.fpl.fs.fed.us/
- Ref 9.3* Non-Poisonous Timber Protection: Practical Action, www.practicalaction.org
- Ref 9.4* Finding Alternatives to Persistent Organic Pollutants (POPs) for Termite Management: UNEP, www.chem.unep.ch/termites/GTEGGuidance.html
- Ref 9.5* Wood Treatment: www.greenbuilder.com/sourcebook/
- Ref 9.6* Pesticide Information Profiles: <http://extoxnet.orst.edu/pips/ghindex.html>
- Ref 9.7* ToxFaq: *Fact sheets on chemical contaminants*. US Department of Health and Human Services, <http://www.atsdr.cdc.gov/toxfaq.html>
- Ref 9.8* Why House Paint Fails: U.S. Department of Agriculture, Forest Service, Forest Products Laboratory, 1995, www.fpl.fs.fed.us/
- Ref 9.9* Bamboo preservation: <http://practicalaction.org/practicalanswers/>
- Ref 9.10* Vertical Soak Diffusion Treatment Manual: Linda Garland, Environmental Bamboo Foundation, 3rd ed. 2005, www.bamboocentral.org.
- REF 10 LOGISTICS
- Ref 10.1* Environmental Health and Safety Guidelines: World Bank, www.ifc.org/sustainability
- Ref 10.2* Safe stacking of sawn timber and board materials: Health and Safety Executive UK, 2000, www.hse.gov.uk
- Ref 10.3* Road Haulage of Round Timber: The Roundwood Haulage Working Party, www.ukfpa.co.uk
- Ref 10.4* Guidelines for the Storage and Erection of Trussed Rafters on Site: Trussed Rafter Association, www.tra.org.uk

This book is available for download from the following websites:

<http://ochaonline.un.org/lisu>

www.humanitarian timber.org