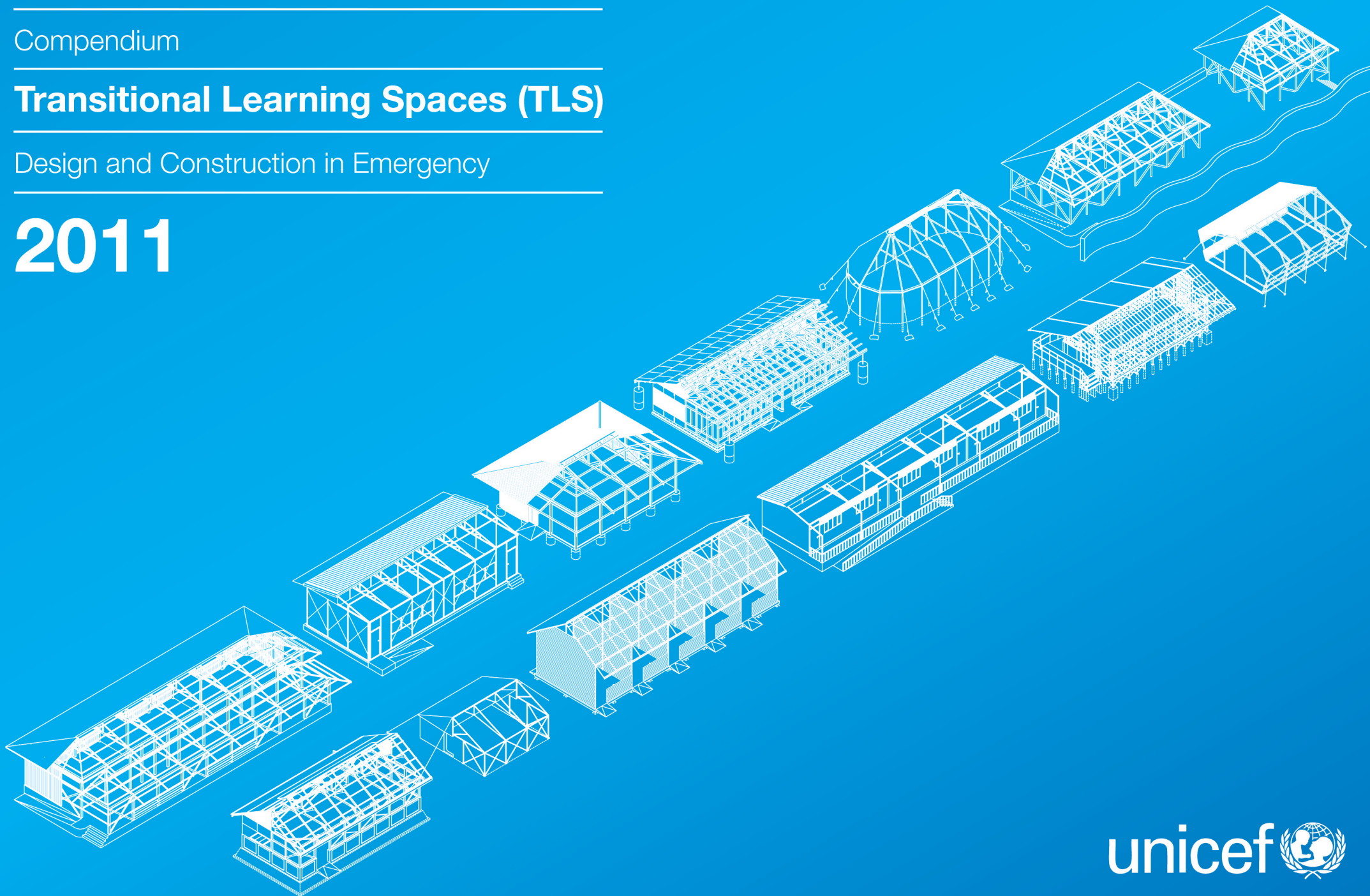

Compendium

Transitional Learning Spaces (TLS)

Design and Construction in Emergency

2011



Acknowledgements

Project leader: Carlos Vasquez, UNICEF, Programme Division/Education

Project consultant: Annika Grafweg

Project team: Hikaru Kitai, Seki Hirano, Jonathan Buckland, Rui Zhang, Sara Dabouni, Maryam Gomary

Graphic design: Darren Cohen, David Windmill

Special thanks to the following individuals who have been essential in the compilation of this compendium:

Shamima Afroz, Sriskandarajah Arulrajah, Htay Htay Aung Mario Bacigalupo, Charlotte Balfour-Poole, Tom Corsellis, Nabendra Dahal, PK Das, Simon Devine, Luca Ginoulhiac, Brenda Haiplik, Charlie Mason, Timothy Mutunga, Paul Neale, Andrew Powell, Jack Ryan, Wamidh Shammas, Dissanayake Somapala, Karel Storck, Ann Wang, Khalid Zaheer,

Photographs are reproduced by kind permission of those whose names appear next to them.

November 2011



UNICEF
Programme Division/ Education
3 United Nations Plaza
New York, NY 10017 USA
www.unicef.org/cfs

Commentaries represent the personal views of the authors and do not necessarily reflect the positions of the United Nations Children's Fund.

The designations employed in this publication and the presentation of the material do not imply on the part of the United Nations Children's fund (UNICEF) the expression of any opinion whatsoever concerning the legal status of any country or territory or of its authorities or the delimitations of its frontiers.



Bangladesh: Children in class within TLS after Cyclone Sidr

Photo: UNICEF/Carlos Vasquez



Photo: UNICEF/Madagascar

Madagascar: Women participated in TLS construction by sewing tarpaulin sheeting

Case studies have been provided from the programmes of the following organisations:

- Education for All
- NRC (Norwegian Refugee Council)
- Plan International
- Save the Children, USA
- UNICEF Bangladesh (United Nations Children's Fund)
- UNICEF China
- UNICEF Copenhagen
- UNICEF Haiti
- UNICEF Madagascar
- UNICEF Myanmar
- UNICEF New York
- UNICEF Pakistan
- UNICEF Rwanda
- UNICEF Sri Lanka

ARC	American Refugee Committee
BoQ	Bills of Quantity
CCC	Core Commitments for Children
CCCM	Camp Coordination and Camp Management
CFS	Child-friendly Spaces/Schools
DRR	Disaster Risk Reduction
ESD	Education and Sustainable Development
GCI	Galvanized Corrugated Iron
HFA	Hyogo Framework for Action
IDP	Internally Displaced Person
INEE	Inter-Agency Network for Education in Emergencies
PAP	Port-au-Prince
PTA	Parent Teachers Association
MDG	Millennium Development Goals
MSEE	Minimum Standards for Education in Emergencies
NGO	Non-governmental Organisation
NRC	Norwegian Refugee Council
RC	Reinforced Concrete
TLS	Transitional Learning Space
TSS	Transitional School Structures
UNICEF	United Nations Children's Fund
UNHCR	United Nations High Commission of Refugees
WASH	Water, Sanitation and Hygiene

Executive Summary

Introduction

Section A	Principles of Transitional Learning Spaces
A 1.0	What is a Transitional Learning Space (TLS) ?
A 2.0	When have TLS been built?
A 3.0	How soon after the disaster event should TLS be built?
A 4.0	Time / cost / quality relationship (lifespan)
A 4.1	Construction costs
A 4.2	Budgeting (labour costs and transport)
A 4.3	Construction time / process
A 5.0	Materials
A 6.0	Who is building?
A 7.0	Participation and consultation
A 8.0	Child-Friendly School Principles (CFS)
A 8.1	Cultural appropriateness, security, and child protection
A 8.2	Water, Sanitation and Hygiene (WASH)
A 9.0	Disaster Risk Reduction, School safety
A 9.1	Disaster risk reduction
A 9.1	School safety
A 10.0	Maintenance

Section B	Design Guidance
B 1.0	Site selection
B 1.1	Orientation, siting, vegetation, trees
B 1.2	Access to site, route to school
B 2.0	Basic planning and design principles
B 2.1	Floor area per child and classroom shape
B 2.2	Water, Sanitation and Hygiene
B 2.3	Outdoor space
B 3.0	Thermal comfort, ventilation, shading, passive solar
B 3.1	Lighting
B 3.2	Thermal comfort
B 3.3	Acoustics
B 4.0	Land, Sites and Services
B 4.1	Drainage
B 4.2	Services
B 4.3	Land ownership issues

Section C	Case studies Overview
C 1.0	Pakistan / UNICEF / Flood / 1
C 2.0	Rwanda / UNICEF / Earthquake
C 3.0	Madagascar / UNICEF / Cyclone
C 4.0	Sri Lanka / UNICEF / IDP Camp
C 5.0	Madagascar / UNICEF / Cyclone (Aluronda)
C 6.0	Myanmar / UNICEF / Cyclone
C 7.0	Somalia / NRC / IDP Camp
C 8.0	Bangladesh / UNICEF / Cyclone
C 9.0	China / UNICEF + UNHCR / Earthquake
C 10.0	Haiti / UNICEF / Earthquake
C 11.0	Haiti / PLAN / Earthquake
C 12.0	Haiti / Save the children / Earthquake
C 13.0	Pakistan / UNICEF / Flood / 2

Section D	Innovative Practices
D 1.0	Education in a box - container school
D 2.0	Pakistan / Proposed / TLC
D 3.0	Water Bottle Light
D 4.0	Solar Light
D 5.0	Ceramic Water Filter for Classrooms
D 6.0	Recycled Blocks
D 7.0	Banana Leaf Sanitary Pads

Annex	
1.0	Further Reading and links

*Only by being true to the full growth of all individuals who make it up,
Can a society by any chance be true to itself.*

John Dewey

The tsunami of 2004 was one of the biggest natural disasters in modern history. The devastation spanned across many borders and was economically disastrous to local communities. Thousands of people were killed and the cost of damage to and loss of infrastructure was calculated in billions of dollars.

Subsequent reports, evaluations and lessons learned showed that poor communities were affected the most. And among these communities children were the most affected, and their ability to continue their education was severely compromised. Schools were destroyed, teachers died or were relocated, families were broken apart and the process of reconstruction took years to bring some level of normalcy to their shattered lives.

Since then, organizations like CARE, Plan, UNICEF, Save the Children and the World Bank, have spent millions of dollars in school reconstruction in post-emergency situations year after year; Haiti, Japan, Myanmar, Nicaragua, Pakistan and most recently the Philippines are a few examples. Despite the many gains made in humanitarian and development assistance since the Indian Ocean tsunami eight years ago, the response from the international community in regards to transitional learning spaces (TLS) is slow and inappropriate for the well-being of children; inaccessible learning spaces, cramped spaces, mud floors, poor access to water and sanitation, unsafe structures and poor site selection are just some of the poignant issues that are ever-present in the implementation of TLS after an emergency.

This project and the idea to create a compendium of TLS that have been implemented thus far is a humble attempt to create a more effective way to respond and provide access to quality education for all children after an emergency situation. This compendium is a centralized collection of designs, pictures, technical drawings, bill of quantities and cost-effective recommendations from different case studies collected from the field. This project aims to help facilitate the job of implementing learning spaces after an emergency, with sound and clear technical information. Each case study can be adapted to local conditions after a proper technical analysis of the current emergency situation. Furthermore, the planning and response time for building TLS will be reduced by approximately four weeks compared to existing practices.

Recommendations for each case study are based on the Child-Friendly School Principles that guide the process to deliver healthy, safer, inclusive and effective learning environments for children. Community participation, access to water and sanitation, local ownership and environmental issues are also identified as key components for a more sustainable result with a greater return to children and local communities.

The frequency and devastation of natural disasters fueled by climate change have not decreased in the last eight years. Conflicts have also disrupted the lives of millions of children in many parts

of the world. Children in the most marginalized groups – such as children with disabilities, ethnic minorities, girls, the rural poor, displaced and slum dwellers – are the most affected, with the least chances for survival and a healthy recovery. We must find ways to become more effective in the work we do and be more accountable for the mandate that was placed in our hands. We must never stop placing the interest of children at the very center of every decision-making process, from the design to the construction of learning environments. This compendium is an attempt to provide a tool to help us attain these goals.

Carlos Vasquez
Education Specialist
Child Friendly School Designs

Disasters have a devastating impact on communities including physical harm, loss of life and wide-reaching psychosocial harm. Disasters have resulted in the damage or destruction of school facilities, the prolonged disruption of education, limited access to schooling and decreased education quality.

Following the 2010 floods in Pakistan, it is estimated that 1.6 million children were affected from schools being damaged or used as shelters. Mozambique recently declared a state of national emergency after flooding affected thousands and forced hundreds of schools to close. Natural disasters in Haiti, Myanmar and most recently in Japan have had similarly devastating effects. The most vulnerable and marginalised communities and children are often disproportionately affected by disasters. Disasters are therefore exacerbating the exclusion of some 70 million children out of school worldwide, and are rolling back years of progress toward attaining Education for All commitments and the MDGs.

School safety and education are both key to reducing the impact of disasters. The role of education in reducing disaster risks is enshrined in all global commitments and frameworks. Foremost among them is the Hyogo Framework for Action (HFA), which has acknowledged education as one of its five Priorities for Action. Complementing the HFA is the UN Decade for Education and Sustainable Development (ESD) (2005–2014) in which Disaster Risk Reduction (DRR) is stated a core priority. Furthermore, the Core Commitments for Children in Humanitarian Action (CCCs) constitutes UNICEF's central policy on how to uphold the rights of children affected by humanitarian crises. The CCCs promote predictable, effective and timely collective humanitarian action for its programme commitments including WASH, child protection and education.

Emergencies can, however, present an opportunity to strengthen disaster risk reduction by 'building back better'. For this to take place an integrated approach for safer school environments for all children is needed from the onset and it is important to create close links with other sector initiatives, such as WASH in schools, as well as providing clear links to other key documents that address the safety and education of children in emergencies.

This compendium of transitional learning spaces in emergencies will ultimately benefit the children and its communities who have lost their school infrastructures and learning environments due to the devastating effects of a disaster. To this end the compendium aims to equip field practitioners with a selection of documented TLSs that have been implemented in past emergencies to capitalise and pass on the knowledge that has been gained from past emergency responses. The compendium reviews and provides practical insides on how to implement TLSs that are most appropriate for various types of emergency situations with strong links to WASH in schools initiatives.

The 13 selected case studies have been chosen from different types of disasters include earthquake, floods and high winds. The compendium documents a wide selection of projects with varying degrees of structural complexity, cost, construction time, community participation, construction modalities and locations. It illustrates the distinctive nature of each emergency situation and the very specific responses.

All documented TLSs are part of the overall reconstruction efforts and an important component within the early recovery stage. They are the first step on a continuous process of school reconstruction activities to achieve durable and sustainable solutions. Several case studies demonstrate this process through upgrading of initial tent solutions or subsequent construction activities for semi-permanent learning facilities. The TLS phase (approximately six month lifespan) and semi-permanent solutions (approximately 30 month lifespan) aim to give local governments and other partners enough time to effectively plan and implement safe, permanent and user-friendly school facilities.

All case studies are documented in a standard architectural form of technical drawings, BoQs, photos and relevant information with regards to construction skill required, lifespan, cost, construction time, materials, site selection, etc. This collated information offers a solid and clear base for decision makers, field practitioners, technical staff (engineers, architects) local communities and all partners in the event of an emergency. It gives easy access to relevant information to assist rapid development of specific solutions for transitional learning spaces in accordance with the national standards and local settings.

Complementing the standard form of documentation, the compendium also offers improvements marked in blue on the technical drawings. These improvements should not be understood as a criticism of the past case studies, but rather as considerations for future implementations. The suggested improvements aim to assist in continuously improving the quality, cost effectiveness and child-friendliness of future TLS projects.

The compendium references other sector initiatives, such as WASH in schools compendium ¹ and other relevant publications such as Guidance Notes on Safer School Construction, UNICEF Child-friendly schools Manual and Minimum Standards for Education in Emergencies, Chronic Crises and Early Reconstruction. Furthermore, it gives guidance on important issues of site selection and analysis as well as Disaster Risk Reduction measures.

In addition, the compendium includes a chapter on innovations. These ideas have not yet been implemented and tested within an emergency response. However, they offer inspiration and innovative practices that may be included in future TLS projects.

The compendium project aims to raise awareness to key issues that need to be considered when implementing TLSs in emergency situations and present through the case studies the complex set of aspects that comprise a child-friendly learning environment. It aims to contribute to the understanding that a TLS is not a stand-alone structure 'classroom', but a holistic learning environment including a set of facilities, including WASH facilities, external play space, internal learning spaces, teacher/staff space and perimeter fencing. These are arranged within a well-considered site layout and are a part of the existing communities. These facilities must be complemented with adequate curriculum, learning materials and teachers, providing a safe and healthy learning environment.

¹ www.unicef.org/wash/schools/

Section A

Principles of Transitional Learning Spaces

A 1.0 What is a Transitional Learning Space (TLS)?

The documented case studies show that there is a great variety of examples of transitional learning spaces, each of them different and specific to the emergency situation they respond to and the available resources including human capacity, financial resources and available materials. A wide span of TLS examples are included that have been implemented in different contexts within the early recovery phase and consequently demonstrate significant differences in respect to their design complexity, cost, construction modality, construction time, lifespan and materials used. Some are entirely constructed by locally sourced materials and built by the local community themselves within a few days. In other cases imported or prefabricated construction systems were used that have much longer lifespans and have a higher cost.

Basic characteristics of a TLS:


- Mud floors are not recommended and should be avoided. Avoiding worm infestation is the main reason to provide a sealed floor. Heavy tarpaulin or if possible concrete slabs can provide a sealed floor.
- Materials like thatch or straw have a high degree of flammability, placing children at risk in case of fires, a second exit door is essential in these circumstances.
- All TLSs must provide access to water and sanitation. This component can be coordinated with the WASH working group or cluster.
- TLSs that are implemented within IDP camps should carefully choose the most secure and accessible space within the camp.
- Community participation is key to guarantee ownership, increase level of safety and disaster risk preparedness.
- Tents that specify a more structurally sound steel structure can be reused/recycled into a semi-permanent structure like in the case of Haiti C10.0 P142
- The planning of the TLS should be a cross-sectorial effort to increase effectiveness and quality of results for children.
- The guidance of an architect, engineer or building professional must be sought.

A 2.0 When have TLSs been built?

All the selected transitional learning spaces have been constructed as a response to various emergencies including earthquakes, floods, hurricanes, cyclones and landslides. (The exceptions are Somalia and Sri Lanka, which are conflict-related emergencies.) In all the case studies the existing school facilities were severely damaged or completely destroyed; disrupting the education of large numbers of children in each case. No other community facilities such as community halls, churches and so forth were available to accommodate schooling. To re-establish education activities as soon as the emergency situation allows is a key objective to prevent the prolonged disruption of education, limited access to schooling, decreased education quality, and rolling back years of progress toward attaining Education for All commitments and the MDGs. The documented TLS contributed to span the time gap until permanent structures can be planned and built or existing structures repaired. Moreover, transitional learning spaces cannot substitute reconstruction of education system, and proper reconstruction of the education system should remain the top priority of the state and other duty bearers.

A 3.0 How soon after the disaster event should a TLS be built?

The question when TLS activities should begin– how soon after the disaster event– is a very important issue that requires an emergency-specific solution. It requires a coordinated response in consultation with the local governments, the affected community members/children, the active cluster system (education/shelter/WASH/Protection/Health and CCCM cluster) or any other coordination mechanism that might be in place.

 [Minimum standards for Education in Emergencies](#)

Case study examples

In several case studies, Haiti C10.0 P142 and Pakistan C13.0 P192 a phased approaches were taken, whereby imported classroom tents were upgraded (Haiti) or replaced (Pakistan) by more durable semi permanent structures. Other case study document (Madagascar C5.0 P76 and Myanmar C6.0 P92) rapidly constructed (several days) locally sourced TLS, that were built by the community and gradually upgraded with reclaimed more durable materials.



Myanmar: Bamboo TLS built with local materials rapidly after cyclone Nagris.

A 4.0 Time / cost / quality relationship (lifespan)

In any construction project there is a triangular relationship between a) the time it takes to construct a building, b) the available construction budget and c) quality of the completed building. This relationship is visible in all case studies and the summary graph on page 19 (to follow) places the individual implemented TLS in relation to each other. In general it can be extrapolated that the greater the complexity of the design and the anticipated life span, the longer the construction time and greater the cost. It is therefore important to engage in a careful planning exercise to find a ‘needs-driven’ project-specific solution.

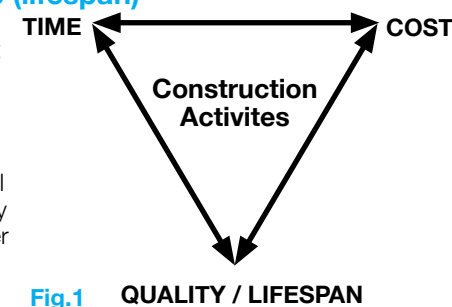


Fig.1 QUALITY / LIFESPAN

To this end, several case studies demonstrate that engaging a construction expert/engineer/ architect is important to plan, design, budget and supervise the construction project effectively. Even though the TLS structure itself may be simple or even imported and not expensive, the overall project cost for all facilities, site issues, planning and construction supervision add up to large project costs that require the same protection of investment and monitoring as permanent structures. Above all, engaging the right technical staff will guarantee the safety of children in the short and long term.

Section A

A 4.1 Construction costs

The construction cost should be reasonable within the emergency context and should be appropriate to the available budget. Several factors impact the construction cost, such as the required time scale, materials, labour/skill available, need for transportation of materials, required lifespan/quality and context (climate, urban/rural, site conditions, land purchase). In general it is important to keep a balance between the cost of the individual classroom, the number that has to be built and required quality of structures. It is important that this balance is planned from the onset. This exercise will enable the right number of facilities (classrooms, latrines, fences, teacher spaces) with appropriate quality to provide access to education for all children for a child-friendly environment.

A 4.2 Budgeting (labour costs and transport)

To be able to budget sufficiently for the construction of TLS within the context of an emergency it is important to take several interrelated aspects into consideration:

- The overall number of TLSs and other facilities that are required;
- The current market cost of the selected construction materials;
- The cost of skilled and unskilled labour (this might vary due to the impact of the disaster);
- The cost of transportation and safe storage of materials;
- Site preparation/cleaning costs
- The cost of supervision/monitoring of the construction works and overheads that may apply.

A market study should be conducted for materials and labour cost during the planning of the TLS to be able to budget and programme realistically.

A 4.3 Construction time/process

The construction time should be programmed to be reasonable within the emergency context and is also determined by many interrelated factors. In general, there are three main programme phases: the planning stage; the tender/procurement stage; and the construction stage.

Within the planning stage particularly the length of making rapid decision on a suitable design and the preparation of project documents (such as technical drawings, specifications, BoQs, construction programme) will impact the start of construction. Furthermore, the process to gain permission to access the site and obtain any required legal permission to build can be a lengthy process.

Within the procurement stage the availability and transport of the specified construction materials as well as the availability of labour is a key factor determining the timeframe. Site preparation works, such as levelling of slopes, demolishing works and site clearance of damaged school buildings, requires time and is an important aspect of the construction phase.

The main determination of the completion of the construction within the set timeframe is a rigorous construction supervision procedure and the skilled personnel to do so.

Case study examples

The documented case studies have used various strategies to respond to their specific emergency situation and to achieve the commencement of education as soon as possible. In the case of Haiti C 10.0 P142 a phased approach was taken, where the imported classroom tents were upgraded to semi-permanent structures in the second phase. In the case of Madagascar C 3.0 P50 an already field-tested locally sourced structure was erected by the community within a day and was gradually upgraded by the re-use of materials from the damaged classrooms.



Photo: UNICEF/Madagascar
Madagascar: Upgrading of a TLS tent for with re-claimed flooring from damaged classrooms

A 5.0 Materials

The choice and availability of construction materials is a major factor in the design of the transitional learning spaces (latrines, fences and external spaces). If it is possible within the emergency context, materials should be locally sourced. This depends on their local availability or easy procurement within a reasonable time frame. This could include the reusing of materials from damaged school facilities. The choice of material is also dependent on the availability of labour that is skilled to work with them. Some materials are more suitable for specific climates than others. A good indication of suitable materials can often be found in the local vernacular buildings, which predominately use locally sourced, climatically suitable materials and construction methods.

The choice of material has a direct impact on the level of maintenance activities that will be required. The associated maintenance cost should be taken into consideration as most schools do not receive or receive very little amount for maintenance operations.

Care should be taken when selecting materials on toxic or hazardous components. Toxic construction materials such as toxic paints or materials containing asbestos must not be used for TLS construction.

Case study examples: Best practise

In case study Madagascar C 3.0 P50, the material choice was determined by the lack of road access, the reuse of materials from the damaged school, the available local materials, which were given in kind contribution by the community and the participation by local women in the construction activities of sewing the tarpaulin. In case study Somalia C 7.0 P104, the material choice was predominately determined by ability to be demounted by the local community and re-erected in a different place, due to the insecurity of tenure within the IDP camp in Mogadishu. In Haiti, case study C 10.0 P142, the design concept to upgrade the first phase imported classroom tent structures determined the material selection for the second phase upgrading activities, while providing earthquake resistant construction.



Haiti: upgraded imported steel structure TLS tent

Case study examples

In the case study Haiti C 11.0 P158 a crew of young men were trained by the architect to assemble the timber structure on site. This case study is a good example of demonstrating the benefits for the project when skilled professionals leading the design and construction activities. In the case study of Myanmar C 6.0 P92 the construction cost were reduced by more than half when the local community and PTA constructed the TLS in contrast to a private construction company.



Haiti: Crew of young Haitian construct TLS

A 6.0 Who is building?

The three main types of construction modalities that have been used by the documented case studies are:

- **Community-led construction:** in the case studies C 3.0 Madagascar, C 6.0 Myanmar, C 7.0 Somalia, C 10.0 Haiti the community constructed the TLS themselves under the supervision of a skilled foreman and or architect/engineer;
- **Local contractor:** in the case studies C8.0 Bangladesh, C 12.0 Haiti, the local craftsmen erected the structures;
- **Construction companies:** in the case studies of C 4.0 Sri Lanka, C 9.0 China, C 10.0 Haiti, C 13.0 Pakistan a construction company built and assembled the prefabricated TLS models.


All three construction modalities require and benefit from the knowledge of an architect/engineer that can assist in planing construction administration and site supervision to maximise the use of resources and increase quality.

The choice of construction modality depends on the specific emergency context, the choice of material and construction method, the anticipated timeframe for completion and the availability of skilled labour. The availability of skilled labour and materials are often severely limited after disasters, due to harvest seasons cycle for construction materials (grasses), the destruction of harvests and technically skilled craftsmen are engaged in shelter reconstruction activities.

In several case studies the construction activities were part of a livelihoods and skill training programme where the construction activities offer a chance for knowledge and cash transfer to communities.

A 7.0 Participation and consultation

The participation of affected people, the community, children and staff throughout the whole project is an essential component of any successful TLS project.

 [Minimum Standards for Education in Emergencies](#)

The active and transparent participation of affected people without discrimination, the children community, and staff throughout the whole project is an essential component of any successful TLS project (MSEE: Domain one, Standard 1: Participation). The engagement of the children, community and staff in needs assessment, preparation of the design brief, appropriate construction modality, materials and construction method, implementation, monitoring and evaluation is vital to promote ownership of the structure, develop culturally appropriate child-friendly learning spaces and respond to children's psycho-social needs, especially if they have experienced the trauma of a recent emergency.

 [SEAT, Schools Environmental Assessment Tool](#)

Case study examples

In the case study of C 9.0 P132 in China a prefabricated solutions was implemented because the children in the affected earthquake area were scared to be inside buildings that were constructed from the same materials as the buildings they had seen collapsed. The prefabricated schools gave assurance to the children to feel safe within their new schools and therefore promoted their attendance and ability to learn.

In Haiti, C 10.0 P142 children expressed their fear and reservation to enter reinforced concrete buildings, as they saw much concrete building collapse and kill their inhabitants. The children preferred the lightweight timber structures as the final choice for a learning space.

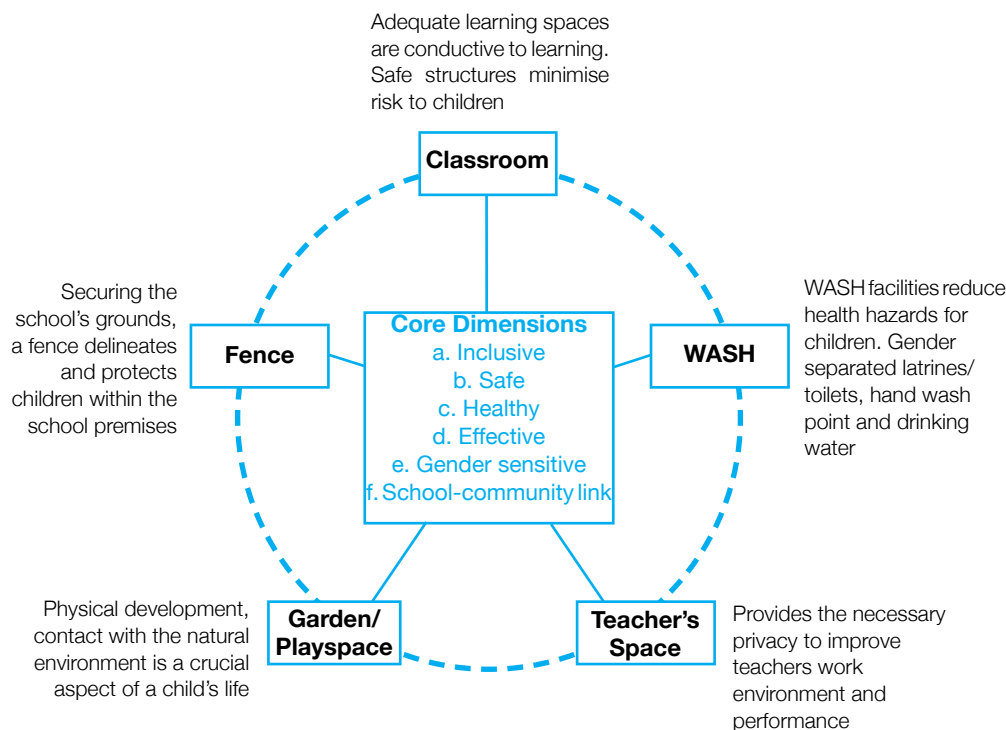
The design brief should also be developed in consultation with the local governments, the shelter/education/WASH/protection/health and CCCM cluster or any other coordination mechanism that might be in place, and must take reference to existing national building codes and standards. (if existing) or international best practises and building code. The coordination of response is required to improve consistency between organisations and between sectors of response within organisations. For example, it is essential that TLSs must not be built without the provision of adequate WASH (Water, Sanitation and Hygiene) facilities, including school appropriate gender separated latrines, hand wash points, drainage and drinking water. To this end close coordination with the WASH sector is essential.

A 8.0 Child-Friendly School (CFS) Principles

There are six key dimensions that a child-friendly TLS design should follow as a guide to create an inclusive, safe, healthy and protective learning environment for all children.

 UNICEF child-friendly schools manual

Fig.2 Core Dimensions of Child-Friendly Schools



a. Inclusive environment: Child-friendly TLSs require an inclusive school environment, where the physical environment and buildings make provisions for all children, including provision for accessibility for children with disabilities and girls in form of gender separated latrines and wash facilities. In particular: access ramps to classrooms and latrine, child-height handrails, reduced stair heights, door openings of a minimum of 850mm and special design of accessible latrines. Also the accessibility to external spaces and the route to school should be included in the analysis and inclusive design process. (UNICEF, CFS Manual, Chapter 2.3)

All case studies have as recommended ramped access to the classrooms indicated on their technical documentation. Particular attention to ramped access to all facilities has been given in the case studies of Bangladesh C 8.0 P116 and Pakistan C 13.0 P192

b. Safe and protective: Child-friendly TLS must be safe and protective environment for all children, it is crucial to design and built structurally safe with particular consideration to context and site specific hazards, such as earthquakes, floods, high winds, mud slides, fire, etc. The site layout, selection and design of facilities must contribute to creating a protective and safe child-centred environment, where children feel safe. This includes the provision of perimeter fencing, easy supervision of latrine facilities by teachers and control of entrance to the TLS grounds. The route to school needs to be part of this consideration for protection. (UNICEF, CFS Manual, Chapter 5.2.2/ 3.3.3)

c. Healthy environment: Child-friendly TLS must provide healthy and hygienic facilities , the close coordination with WASH is essential. This includes appropriate gender separated latrines, hand wash points, drinking water, site drainage and waste disposal as vital in providing a healthy learning environment. The inclusion of sealed internal flooring provides protection from vector diseases. Based on field experience a close coordinated effort between education and WASH can take place around the third week after the emergency. The WASH sector by this time has covered essential needs to the population and the clusters have been activated. Discussions between the two sectors can commence as early as the first week of the emergency. (UNICEF, CFS Manual, Chapter 5.2.1)

d. Effective with children: Child-Friendly TLS are enabling learning environments where children can thrive; therefore TLS need to be comfortable and child-centred spaces with good quality natural lighting, sufficient ventilation and comfortable internal temperature through sun shading and appropriate material use. The TLS need to be simple and open-plan spaces with flexible furniture arrangements to encourage group learning and child participation. (UNICEF, CFS Manual, Chapter 3, Table 3.1)

e. Sensitive to gender: Child-friendly TLS must give attention to the needs of girls, in particular to the provision of gender separated latrines, private space for washing within the girls toilet, clear line of sight for entrances of latrines to allow supervision and innovative design solutions to include girls in outdoor play and activity spaces. The route to school should be included within this. Additional supervision in the form of a parent/teacher on the route may be necessary. (UNICEF, CFS Manual, Chapter 5.2.2/ 3.5.1)

f. School-community link: Child-friendly TLS are vital parts of the community. Community participation and engagement of parents, children and staff into the rapid decision making processes on TLS design and location, fast erection/building works of suitable spaces, clearing of sites, setting up of maintenance and DRR operations is crucial. (UNICEF, CFS Manual, Chapter 3.6/Chapter 4)

The case study of Madagascar C 3.0 P50 gives a detailed working plan and tools that are required to erect the locally sourced tent structure in one day.



Photo: UNICEF/Madagascar
Madagascar: Tools required for TLS construction

A 8.1 Cultural appropriateness, security and child protection

The political and security situation has an immense impact on the ability to plan, implement, supervise and operate transitional learning spaces. In the case study of Sri Lanka C 4.0 P64, the access to the TLS sites within the IDP camp was very restricted and made the sourcing of building materials and the construction supervision a challenge. In the case study of Haiti C 10.0 P142 in Port-au-Prince, several of the TLSs are located within high-risk areas. The perimeter fencing, supervision points of entering the TLS grounds and the route to school are important to be considered as part of the scope of TLS. The participation of the community, parents and children in decision-making is essential to create emergency context specific solutions where children feel safe and protected.

The use of permanent school structures as temporary shelter for the displaced is not part of the scope of this compendium. However, past experiences have shown that this is often the case. Even in the best cases that education is not disrupted, the influx of a large number of people into the school grounds places strain on the facilities (latrines) and increases the vulnerability of the children.

A 8.2 Water, Sanitation and Hygiene (WASH)

Past experiences have shown that the absence of the 'hardware' component, gender separated and appropriate latrines have an immense impact on girls to continue their education after/during an emergency. The lack of coordination between education and WASH can also have less than desired results to provide access to quality learning spaces.

This compendium sits alongside the UNICEF WASH compendium, which is available on request from UNICEF.

www.unicef.org/wash/schools/

A 9.0 Disaster Risk Reduction, School safety

A 9.1 Disaster Risk Reduction

The TLS must not be designed in a way that increases risk of injury or death in case of future hazard events as long as they are in use. Example: aftershocks, high winds, flooding and seasonal winds can have serious negative consequences on structures and children if not planned appropriately. The TLS must be designed and located on the site in a way that mitigates risk of future hazard events and protects children from injury in the case of collapse or damage. In addition, a second exit from the TLS for fast escape and access to a safe place outside needs to be planned into the site layout and design.

In addition to the safety provision in the design, a construction monitoring and supervision procedure needs to be in place to make sure that the construction quality is executed to safe construction standards according to the technical specifications and construction drawings and building codes.

Fire prevention and emergency evacuation plans must be part of the design process and part of the school operations. Combustible materials should not be used for structural purposes unless treated to resist fire. In several case studies bamboo matting or other combustible materials have been used for roofing or wall cladding. In these cases a secondary exit door is important to allow for fast escape in case of fire, earthquake, etc.

A 9.2 School safety

When implementing TLSs after a disaster it is important to make sure that the surrounding school site is cleared of any hazards, such as unstable earth from landslides, fallen electrical wire, glass, sharp metals, debris, fluids and solid and gaseous wastes etc. Special prevention must be taken if TLSs are located within existing school grounds with destroyed or damaged school facilities. These must be closed off to protect children from injury. Furthermore, the TLS should not be located where future reconstruction is planned, as it would disrupt the education.

In the case of TLSs in forms of tents as in the case studies of C 5.0 P70 in Madagascar, C 10.0 P136 in Haiti and, specific care must be taken in hammering tent pegs into the ground or covering these with sand bags. Also guide ropes or wires should be made visible by flags to prevent children from being injured while moving around the outside of the tent structures.

In addition to the 'hard component' of safe construction it is very important to develop the 'soft component' of risk awareness and risk behaviour of children, staff, parents and the community. Evacuation procedures and emergency drills must be part of the children's school life and curriculum to create awareness and foster active participation in DRR.

A 10.0 Maintenance

The TLS structures should be designed and built so they can be maintained by the local community themselves. It is therefore very important to consider the available craft skills, labour, cost and availability of repair materials and the daily activities and use of the building carefully during the planning process (choice of construction material and technology).

Section A

Past experiences have proven that regularly maintained school facilities provide safer and healthier environment for its users i.e. children, teachers and parents. Especially in disaster prone places better maintained facilities will minimise risks of damage and injury to its users.

As all case studies confirm, well-maintained TLSs last longer and are healthier and safer. Hence are more economical, more child-friendly and make the learning process more productive.

Consequently, it is important to organise community maintenance plans from the earliest time possible. This should include daily routines that could be part of the children's curriculum.

 *Guidance Notes on Safer School Construction, tool for child centred risk assessment, Disaster Risk Reduction begins at school*

Fig.3 Matrix of Maintenance

Actions for Good Organisation

1. Establish school maintenance committee:
Including children, parents, teachers and community
2. Create action plans + emergency procedures, safety drills, evacuation drills
3. Establish Maintenance Budget

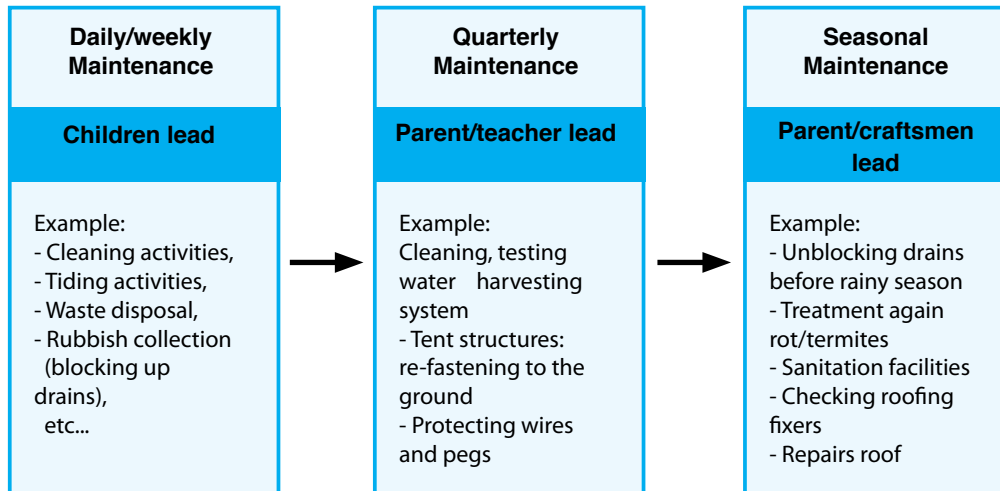


Fig.3 Extract from child-friendly maintenance manual, Myanmar

5. Routine Maintenance (Daily, weekly and monthly)

The routine maintenance consists of daily, weekly and monthly activities, e.g. lubricate the door and window hinges, cleaning of the open drainage, garbage collection in the recycle place/bunker, maintaining vegetation to provide natural retaining wall for the mount, cleaning of the gutter, cleaning the toilets and the floors, etc.

- Broom and wash the floor in the classroom, veranda, teacher room and library every day.
- Remove the furniture from the classroom and wash the floor every week.



- Wash the wall, windows and doors once a week. Remove all kind of pertinent that are generated by insect to avoid further deteriorations.
- Lock all room by the end of the schooling hour every day
- Clean the toilet every day with brush and enough water



- Clean all hand washing bins and the down pipes
- Check all the fixtures and lubricate all hinges generously with proper oil
- Trim the grass and remove the weeds every day



For complete document, please contact: Carlos Vasquez, cvasquez@unicef.org



Section B

Design Guidance

Section B

This section offers some basic design principles that should be considered when implementing TLSs. The principles are based on the best practices and past experiences from the documented case studies. As the case studies show, each individual emergency situation is very particular with its specific TLS design and implementation procedure. Not all design considerations apply to equal measure, importance and priority. To this end, a holistic design and planning process to decide on the appropriate TLS is required for each individual emergency situation.

B 1.0 Site selection

The site selection and location of TLS on the site is extremely important and often more important than the TLS design itself. The wrong site selection or location of a TLS can have a significant impact on the vulnerability of children, structures and the ability of educational systems to function properly. After disaster it is especially important that children feel safe in the transitional school and surrounding environment. Therefore, the site selection must be preparedness focused and have DRR planning emphasis.

As the case studies show, there are different site issues that should be considered during the planning process before construction starts:

The issue of security within an emergency is a significant issue for the site selection, entrance location to the site and the way children have to take to reach the TLS every day. It is therefore important to assess the surrounding area in respect to the risk they pose for children's' safety, protection and health within the TLSs and on the way to TLSs.

(MSEE domain two: Standard 2: protection and well being)

In general, it is advisable to avoid steep slopes, as they typically have the following increased risks: landslides, erosion, problems with road designs and access and maintenance, as well as difficulty with access especially by fire protection equipment and emergency vehicles. Steep slopes make it more difficult to plan for accessible spaces for children with physical disabilities and often require levelling and expensive site works.

Temporary schools, established in the immediate aftermath of an emergency, may face additional risks. For instance, where an earthquake has occurred, buildings in the surrounding areas are more fragile and continually impacted by aftershocks. Likewise, the site may be vulnerable to landslide, flood or cyclone.

Case study examples

In areas with risk of flooding, low lying sites or sites close to rivers or sea shores should be avoided if possible. If this is not feasible, the design of the TLS must take future flooding into consideration, as in the case study of Myanmar C 6.0 P92 and Pakistan C 13.0 P192



Photo: UNICEF/Pakistan
Pakistan: raised floor level to prevent flooding

Many TLSs are constructed within existing school grounds in proximity to damaged or destroyed structures. In these cases the available space may be limited, for example in urban areas. This situation can be seen in the Haiti case studies. In these situations particular attention has to be given to access and circulation issues and the spaces 'between' the individual TLSs, as well as the closing of damaged structures to protect children from unsafe structures. In addition, debris and any hazards as described under school safety need to be cleared.

TLSs that are constructed on 'new' sites should give particular consideration to protecting the school grounds. For example by a perimeter fence to create a protected space for the children and staff that can be supervised, kept safe and well maintained.

B 1.1 Orientation, siting, vegetation, trees

In addition to the site selection itself, the location and orientation of the TLS on the site can contribute to reducing the vulnerability of the structure and increasing the internal comfort of the TLS. It is therefore important to give consideration to the local climate and plan the site layout and TLS orientation to the sun accordingly. In general (on the northern hemisphere) the hottest afternoon sun comes from the south. Therefore, wide overhanging eaves or other sun protection is needed, as the timber louvers that can be seen on the TLS design for Haiti C 11.0 P152.

Case study examples

In areas with risk of high winds, such as Myanmar case study C 6.0 P92 the orientation of the short side of the TLS towards the prevailing wind direction can help to prevent negative pressure and uplift of the roof.

In the case study of Madagascar C 3.0 P50 with a hot climate, the tent structure with tarpaulin cover has its openings orientated towards the prevailing wind direction to increase ventilation and therefore reduce the internal temperature in the tent contributing to a better learning environment.



Photo: UNICEF/Myanmar
Myanmar: orientation of short side towards the wind direction window blinds

B 1.2 Access to site, route to school

The safe and protected access to the school ground and TLSs and the route the children and staff have to take very day to reach the TLS must be considered in the site layout and selection. The main entrance to the school grounds and the perimeter fencing are important site layout considerations. In general it is best to avoid locations or main entrances close to industrial areas, military camps, large road junctions or traffic interchanges that could increase the vulnerability of the children and staff.

(MSEE domain two: Standard 2: protection and well being)

B 2.0 Basic planning and design principles

All TLS projects must make careful ground condition assessments to be able to engineer foundations that are adequate to the local ground conditions and hazards, such as earthquakes, landslides, flooding and high winds. The TLSs must be designed structurally safe and not in a way that increases risk of injury and death in case of future hazard events as long as they are in use (for example aftershocks, seasonal high winds, etc).

If available, local building codes and regulations must be considered. If not, the TLS should refer to the international building codes. Expert engineering advice by an engineer or architect is required.

 [International building code \(IBC\) 2009](#)

The fire safety of TLS needs to be considered in the design by including an alternative exit to safe place outside. This is particularly important if combustible materials have been used as construction materials, such as roof thatching, bamboo matting etc.(refer to material selection). (*MSEE: Structure, Design and Construction Standard 2*)

The site layout design of a TLS should promote the principle of 'safety through transparency' to protect children of abuse within the TLS, the outside grounds and the latrines. This includes the strategic location of the latrines (gender separated), so the entrance is easily visible from the classrooms and by teachers. The distance should be within easy visibility. The classrooms have enough openings that the activities can be monitored from outside by teachers and principals.

The accessibility of the TLS, the outside grounds, latrines and other facilities by children with special needs should be taken into consideration. As in the case studies of Pakistan C 13.0 P192 and Bangladesh C 8.0 P116, ramps and handrails to the raised classrooms and latrines and wider doors (900mm) were included in the design to facilitate accessibility. Special attention to latrine design is also required in the form of increased size of enclosure and handrails. To allow for an inclusive temporary learning environment attention to the flat access to the outside activity area is required, causing a particular challenge for sites on steep slopes.

B2.1 Floor area per child and classroom shape

The TLSs documented in this compendium allow for a space allocation with a range of 1 sqm- 1.5sqm per child.

This space allocation includes the circulation space inside the classroom that is needed to allow for different furniture arrangements, various teaching styles and specific learning activities, such as group learning and frontal orientated learning activities. It also includes the space for the teacher and teaching assistance to move around freely. In general, space standards should give careful thought to who uses the learning space, and how. Spaces allocations need to be appropriate to these age, physical ability and cultural considerations of all users. A locally realistic standard should be set for maximum class size and keep the local cultural practices in mind. In general it is advisable to increase the square metre per child for younger children and ECD.

(*MSEE: Domain two: standard 3: Facilities and services*)

The documented TLS case studies are predominately rectangular in shape with openings on both sides of the longer elevations. In general a clean open space without internal columns has been

preferred to avoid 'blind spots' and have flexibility within the TLS. The various case studies show culturally different uses of furniture, such as sitting on chairs and tables or sitting on the floor.

Case study examples

As a overall site layout, three main types have been used by the documented case studies: a. individual TLS placed next to each other in a row as in the case study in Myanmar C 6.0 P92, b. multiple TLS arrangements of 2- to 5 classrooms as in case study Haiti C 10/12 P142/170 and c. a 'mixed use' arrangement of TLS with teacher space and outdoor activity space within one structure. The case study in Bangladesh C 8.0 P116 is a good example for this arrangement.



Photo: UNICEF/Carlos Vasquez
Bangladesh: Temporary learning environment with classrooms, office, protected play space

B 2.2 Water, Sanitation and Hygiene

The provision of WASH facilities alongside the TLS is essential. TLS cannot provide healthy and child-friendly learning environments without the adequate provision of school appropriate WASH facilities. These include clean gender separated latrines or the rehabilitation of existing toilet facilities, with adequate water for personal hygiene, hand wash points close to the latrines with water and soap or other cleaning agents for children to wash their hands, clean filtered drinking water and solid waste disposal facilities, such as containers and waste pits.

Privacy, cleanliness and safety are major considerations when planning the location and design of facilities. The latrines for boys and girls should be located in clear line of sight for teachers to have good visibility of the facilities and in not to far distance from the TLS (within 20m). The facilities for girls should provide privacy for washing.

On average, where numbers were given, the case studies provided one latrine per 30 girls and one latrine per 60 boys. (As to sphere guidance for school toilets)

[Sphere project](#)

The accessibility of latrine facilities by children with special needs should be given consideration to contribute to an inclusive learning environment.

Learning environments should have a safe water source. Sphere guidelines for minimum water quantities in schools call for 3 litres of water per student per day for drinking and hand washing should be provided for. (see Sphere standards on water supply / Water Supply, Sanitation and Hygiene Promotion for details)

In addition to the 'hard component', promotion and implementation of soft components; Hygiene education, etc is an essential element of a healthy learning environment.

Section B

The UNICEF WASH compendium gives detailed analysis of WASH facilities in different case studies.

 www.unicef.org/wash/schools/

B 2.3 Outdoor space

Additionally to the internal transitional learning spaces, child-friendly outdoor spaces should be made available for play, physical activities, recreation and for alternative learning activities. It is important when planning the site layout to include outdoor spaces that are hazard free (debris, glass, etc.) safe and protected and fenced.

Case study examples

In the case study of Haiti, existing trees for shading and filtering the sun, dust and noise were planned into the external play spaces as good places for play and gathering.

In the Bangladesh C 8.0 P116 case study, a raised and covered external activity was provided to shade from the sun and possible flooding

Planning the outdoor spaces, such as gardens and vegetable patches, are good ways to involve children in the realisation of a child-friendly school.

B 3 Thermal comfort, ventilation, shading, passive solar (heating)

B 3.1 Lighting

Natural, even and sufficient natural lighting is essential for TLSs. Children should be able to have enough light to see the blackboard and be able to study, read and write.

As shown in almost all case studies, windows or openings are located preferably on opposite sides of the long elevation to achieve even lighting. Approximately 15-20% of floor area should be window area. It is very important that these openings have sun shading in hot climates through blinds, shades, trees and vegetation.

Case study examples

In the case study of Haiti C12.0 P170, timber wooden louvers on the outside diffused the sunlight to give even filtered lighting condition.



Photo: Save the Children/Andrew Powell
Haiti: Louvres protect from sun

B 3.2 Thermal comfort

The TLS needs good fresh-air circulation to avoid heat to build up and excessive humidity. The design of good ventilation through windows or openings particularly in hot climates is important to keep children alert and comfortable. The type and amount of ventilation (wind) can be controlled through window shading, flaps, roof rafter gaps, orientation on site (prevailing wind and vegetation/trees).

Case study examples

In the case study of Madagascar C 3.0 P50 has tent structure has a tarpaulin skin. To avoid overheating of the inside space, a double layer of tarpaulin creates an air gap to cool down the space.

In the case study of Haiti C.12 P170 a roof ridge ventilation gap was used to allow the hot air (which rises) to escape and draw in fresh air through the window openings. This system keeps a continuous natural air exchange.

In the case study of Myanmar C 6.0 P92, it was particularly mentioned that the use of natural local roofing material, such as thatch is a much better insulation than CGI roofing or tarpaulin and recommended the upgrading of roofing material as soon as it is possible.



Photo: Save the Children/Andrew Powell
Haiti: roof ridge ventilation detail

B 3.3 Acoustics

If possible, the TLS should not be located close to sources of excessive noise like traffic, railways, industries etc. as described in site selection and orientation.

In general, some roof coverings are more prone to noise transmission than others. For example, CGI or other metal roof covering is very noisy during heavy rain if it is not insulated. If possible the roof should be insulated with a sound absorbing material. (As part of upgrading activities)

Transmission of noise between adjacent classrooms can be a noise disturbance. In many case studies a half-high partition was built to separate the classroom spaces. It can be considered to extend the partition as part of upgrading activities to a semi-permanent structure.

Case study examples

A successful design solution was found in Somalia C 7.0 P104 by placing an office/store room in between two classrooms to create a sound buffer.



Somalia: storage space in between classroom as acoustic separation

B 4 Land, sites and services

B 4.1 Drainage

External drainage channels around the TLS and particularly around entrances should be part of the site layout consideration. The external drainage channels should drain excess rainwater away from the structures to soak pits drainage channels to avoid flooding. Particularly on sloped or terraced sites, external drainage channels are needed to prevent flooding and erosion.

B 4.2 Services

If available, the connection to the local service grid, such as electricity, drainage and drinking water is an advantage, particularly if located within existing school grounds. This can improve the TLS and could contribute to upgrading it to a semi-permanent learning space with an extended life span.

B 4.3 Land ownership issues

Finding a suitable land aftermath of a natural disaster can be a major challenge, especially in situations where schools are built on community provided land.

Land ownership issues are very important aspects that need to be addressed prior to the start of construction. It can cause significant delay to the start of construction, as well as disruption to construction activities.

Several case studies stated land ownership disputes, particularly in urban areas (Port-au-Prince, Haiti). These case studies had professional legal advice to deal with the land ownership issues. In some circumstances, as in the case study of Somalia, where the TLS is within an informal IDP settlement with no security of tenure, particular design emphasis was given to the easy demountable building technology, the re-use of materials and the use of local craft skills to build the TLS.



RWANDA C 2.0



MADAGASCAR C 3.0



SRI LANKA C 4.0



MADAGASCAR C 5.0



MYANMAR C 6.0



SOMALIA C 7.0



BANGLADESH C 8.0



CHINA C 9.0



HAITI C 10.0



HAITI C 11.0



HAITI C 12.0



PAKISTAN C 13.0

HUMAN INTEREST STORY – TRANSITIONAL SCHOOLS ALLOW CLASSES TO CONTINUE

“I like the school because it’s comfortable.” – Rupa, 10

Sonotonia Government Primary School in Bagerhat district was completely destroyed by Cyclone Sidrin November 2007. While classes resumed within two weeks in a Government-operated club, the single-room was inadequate. Different grades operated in different corners of the room, and most learning materials had been lost in the storm. “It was very hot. There were hardly any chairs or tables and the ones we did have were falling apart,” says class three student RabyaBosree.

The learning environment was so poor that it was impossible for teachers to provide quality education. Students began to drop out, or shift to madrasas or other schools. While community members were concerned, they felt powerless to change the situation



UNICEF, Bangladesh

As part of UNICEF’s Education in Emergencies project a transitional school was constructed, bridging the gap between the disaster and a new permanent building. While UNICEF provided the school design and a grant of 191,000 BDT (2700 USD), the community was actively involved in planning and building the new school. They donated land, labour and money (totalling 15,000 BDT) and bought timber from the local market. With this passionate community involvement the school construction was completed in just 28 days.

Today Sonotonia GPS is brightly coloured and has a child-friendly environment decorated with posters and paintings by children. “I like this school because it’s comfortable and it looks good,” says Rupa, 10, a class three student. There are adequate benches, books and pens, and each grade has a separate classroom. With the new surroundings, enrolment has also begun to bounce back. The number of children enrolled in the school fell from 250 before Sidr to just 52 one year later. Today enrolment stands at 130 students.

The community is proud and has ownership of the school, which is also positively impacting student attendance. “It’s not just that the community have a feeling that it is their school, they know it is their school. They built it themselves. If their children don’t want to come to school on a particular day, parents bring them in and stay with them,” says LuftorRahman, a school management committee member. According to the head teacher NiteshBiswas, attendance rates are about 88%, higher than the national average of 81%¹.

¹Government of Bangladesh, Directorate of Primary Education, Annual Sector Performance Report, 2009.



UNICEF, Bangladesh

HUMAN INTEREST STORY – EMPOWERING EARTHQUAKE AFFECTED COMMUNITIES

By Jenny Clover

Rusizi District, Rwanda, October 2011: It was just after 9am on a Sunday morning three years ago that a devastating earthquake ripped through two of Rwanda's most south-westerly districts, injuring 464 and killing 29, most of whom were praying in church at the time. The communities of Rusizi and Nyamasheke districts, which are just across Lake Kivu from the Democratic Republic of Congo, were badly affected by the earthquake. Across the two districts, 21 schools and three health centres were destroyed or badly damaged. A total of 20,000 children suddenly found themselves unable to attend school.

After an emergency appeal launched by UNICEF, the Government of Japan donated \$7.5million to not only to rebuild the damaged infrastructure, but to "build it back better". Now, just three years on, as UNICEF's reconstruction and improvement project nears its end, the area has been transformed.



Across the two districts a total of 25 schools have been rebuilt, and 200 classrooms, 21 new offices for headteachers and 49 new blocks of toilets have been constructed. A total of 34 water tanks have been installed at schools. All rebuilt schools now adhere to UNICEF's child-friendly schools model, meaning they take a more holistic and child-centred approach to education. In addition, the three health centres have been rehabilitated and 500 new public toilets have been constructed across the districts.

The progress is obvious at the school Sainte Augustin de Giheke, in Rusizi, which was badly hit by the earthquake. UNICEF built a temporary school of tents so classes could continue, while work began on rebuilding the school. Now it boasts new buildings including six classrooms, an administration block, three blocks of latrines, five water tanks and a playground. Headteacher Marcelline Mumpundu, explained the progress: "We were very badly affected by the earthquake and many of our buildings were destroyed. We had to spend three years

teaching from tents. But now we have brand new buildings that are far better than we had before and we are a child-friendly school, which is much better for the children. We also have fantastic facilities, like our new playground, water tanks and latrines. It's made a real difference to how our children are taught."

Vice Mayor of Rusizi, Marcel Habyarimana, said: "Even before 2008 we didn't have enough classrooms in our schools, so when the earthquake happened it was really devastating for the district. The support we were given has made a huge difference to us and to the children. Now we not only have schools which were repaired but we have schools that are even better than they were before and our pupils have improved ways of studying. Lots of important work has been done and our district is very grateful for it."

Just as important as the rebuilding of infrastructure are the social and cultural changes that have been brought about in the communities. As part of the wider rebuilding project, a One Stop Centre against gender based violence was set up in Rusizi in September 2010. It has so far received 203 cases, including 112 children. Victims are given holistic and comprehensive support, including medical treatment, forensic interviews and psychological support.



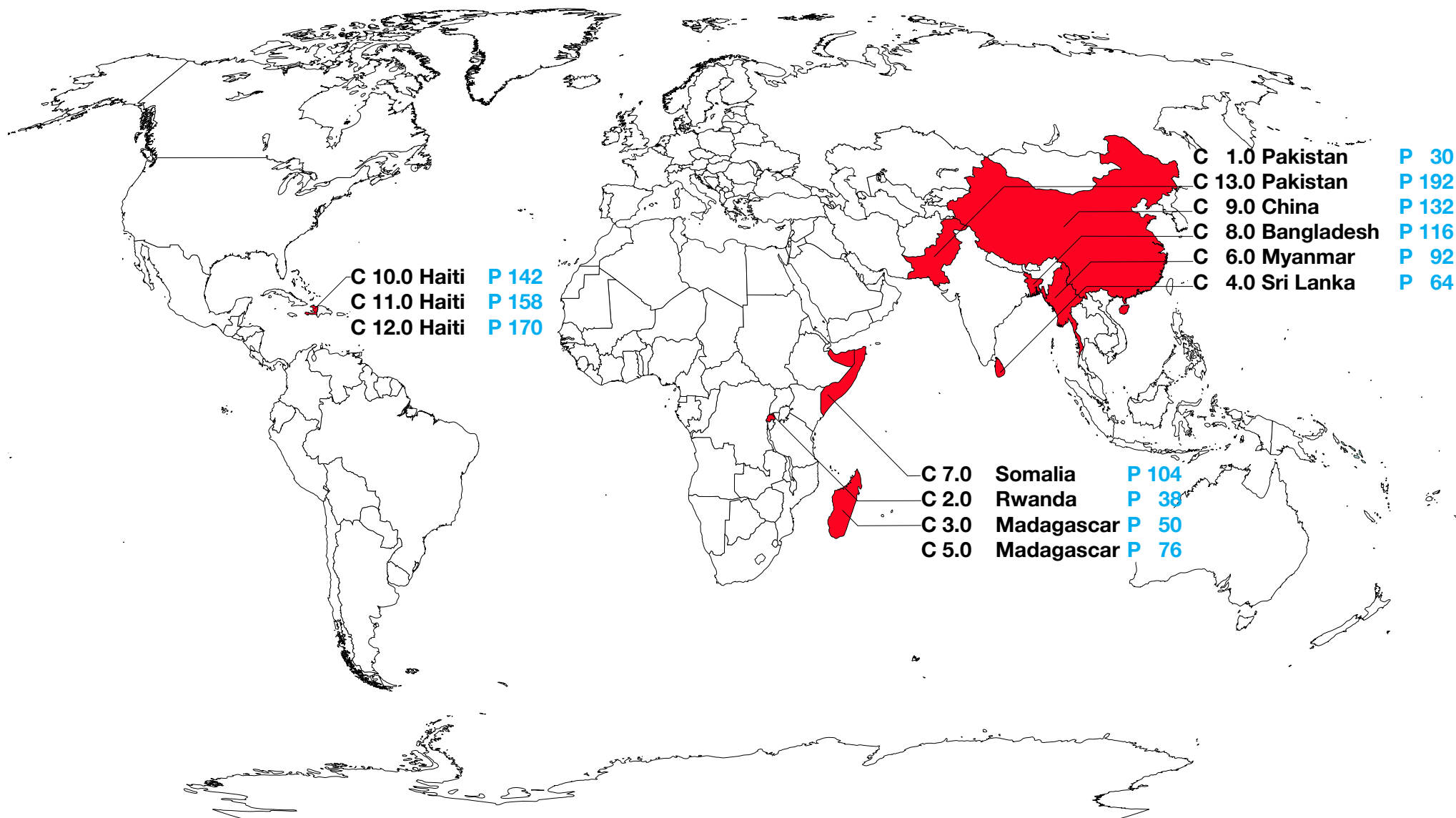
An assessment carried out by UNICEF showed that young people in the south-west region were not sensitised to the issue of HIV and in response the Rusizi child-friendly centre and library was opened in May 2010. It sees around 143 children aged 7-18 coming through its doors every weekend. They have access to games, toys and books and take part in regular group discussions and workshops on topics like sexual health, life-skills and HIV. Children also produce a weekly radio programme which goes out to the local community, discussing issues like child protection, drugs and HIV. A similar centre was built in Nyamasheke.

In a similar vein, the Rusizi Youth Network was formed to empower young people by teaching them about their rights, sensitising them to HIV and sexual health and trying to reduce violence against children. Around 30 different associations and cooperatives make up the network, with more than 1,000 members in total. Lambert Shema, Youth, Sports and Culture Officer for Rusizi District said: "This part of the project is not about rebuilding schools and clinics but it is just as important. We are trying to empower our youth and give them the strength to teach each other important things about health and their rights. The regeneration project after the earthquake is so good because it is so wide – it is about more than repairing buildings." The Network received initial funding for a year, but Mr Shema hopes they will be able to continue the project.

In the three years since the earthquake, the communities within Rusizi and Nyamasheke have been rebuilt and strengthened. In just 40 seconds the 2008 earthquake managed to uproot families and buildings in these communities. It has taken three years of hard work, but now the area has not only recovered but is flourishing.

Section C

Case Studies



Overview

Section C documents thirteen case studies with a set of standard technical drawings, project description, photographs and Bills of Quantities. In addition the technical drawings are annotated with recommended improvements to the design in blue boxes. The case studies are arranged in an order from the simplest TLS project towards the most complex and long lasting semi-permanent structures.

In the matrix below and on the following page, a comparative study has been made to place the documented TLS in relation to each other. The matrix aims to give the reader an overview of all case studies and their specific characteristics. It illustrates the interdependency between the different components of the TLS projects, for example the relationship between the constructions cost, construction time, and material choice and construction modalities. The matrix shows the case study in the left column and the individual project components in the top row.

	Country:	Agency:	Location	No. of Users	Anticipated Lifespan	Actual Lifespan	Facilities provided	No. of Facilities	Construction Time
C 1.0	PAKISTAN 1	UNICEF	Flood affected area in Pakistan	30 children per classroom	3 months	1 month	Classroom structure	-	2 days
C 2.0	RWANDA	UNICEF	Earthquake-affected areas of Rusizi and Nyamasheke district	50 children per classroom	1 year	Lasted for more than 1 year, (tarpaulin required replacing)	Classrooms, portaloo latrines (mobile toilets), WASH facilities (by WASH section)	212 classrooms	4-6 days
C 3.0	MADAGASCAR	UNICEF	Saranindona in Antsiatsiaka	Approx. 50 children per classroom	6 months, (tarpaulin change each 3 or 4 months)	Remain in place since 2008,(upgraded by local materials)	Classrooms, WASH facilities, "School in a Box" ,"Recreational kit", school furniture	250 classrooms	8 hours
C 4.0	SRI LANKA	UNICEF	Northern and eastern provinces, IDP camp of Manik Farm in Vavuniya, Jaffna and Trincomalee district	28-35 children per classroom	1 year (for prefabricated GI pole construction/ thatched roof)	-	5 classrooms per block, outdoor activity/play space, WASH facilities (WASH sector)	Approx. 283 classrooms	3 months for 35 TLSs
C 5.0	MADAGASCAR	UNICEF	Northern region of Sofia, Diana, Sava, Analanjirifo, Vato-vavy, Fitovinany	45 children per classroom	25 years for tarpaulin Stabilised mud block walls/ thatched roof: regular maintenance required	e.g.: Afghanistan's tent version in good condition after 5 years	Classrooms, latrines	90 classrooms	Tent: 4 hours Stabilised mud blocks/ thatch version: 10-14 days
C 6.0	MYANMAR	UNICEF	10 townships in Yangoon region and 7 in Ayeyarwady region	50 children and 2 teachers per TSL	1 year	1 year (lasts up to 3 years when renovated annually)	Classrooms, WASH facilities, furniture	923 classrooms	2 days

Main Construction Materials	Material Sources	Approx. Project Cost	Approx. Material cost/unit	Size of Units	Size of Construction Team	Construction Skill Required	Who Built the Facilities	Site Information
Wood poles, bamboo mats, tarpaulin roof	Locally sourced	500 USD	n/a	18sqm	2 workmen	Basic construction skills	Local craftsmen	No site work
Wood poles structure with tarpaulin covering and wooden window shutters	Tarpaulin by UNICEF, timber poles locally sourced	550 USD	390 USD	48sqm	6 workmen per class-room	Basic carpentry and construction skills	Local carpenters and unskilled community members	Within existing school grounds
Wooden poles and pegs/ tarpaulin sheets/galvanised steel wire	Locally sourced, Tarpaulin (250 gr/m ²) imported	174 USD	174 USD	48sqm	Approx. 9 community members, 1 foreman	Basic carpentry and construction skills	Local craftsmen and community/school community members	Within existing school grounds
Timber poles or prefabricated GI steel structure, CGI sheets, cadjan roof thatching, cement for flooring	Locally sourced	-	-	29.5sqm	-	Basic carpentry and construction skills	Implementing NGO, contractors, School Development Societies	Within IDP camps (limited accessibility), land scarcity particularly after tsunami
Aluminium structure, polyester/PVC tarpaulin, thatch, brick/palm tree mats, screed	Tent imported, walls, roof and floor material locally sourced	8000 USD	Tent : 3600 USD	50sqm	5-6 people for aluminium structure, 1 foreman	Tent: no construction skill needed Stabilised mud blocks/thatch version: skills in thatching/ carpeting/concrete/masonry works	Site foreman and local community members (e.g.: Zambia built by local women)	In rural community provided the sites
Bamboos, betel posts/hard woods, tarpaulin, concrete foundations	Locally if available, nearby townships	Contractor: 1,245 USD Community: 500 USD + tarpaulin (in kind) + latrines	Contractor: 1,035 USD Community: 420 USD	42sqm	10-15 workers, 2 local carpenters	Carpentry and basic construction skill	Local contractor, PTA and local community	Existing school grounds

Case studies matrix

	Country:	Agency:	Location	No. of Users	Anticipated Lifespan	Actual Lifespan	Facilities provided	No. of Facilities	Construction Time
C 7.0	SOMALIA	NRC	Mogadishu and Afgooye corridor, Somalia	40-45 students per classroom	4 -5 years	Those constructed in February 2010 are still intact	Classrooms, head teachers office and stores, WASH facilities	13 classrooms and 5 stores /offices	1 week
C 8.0	BANGLADESH	UNICEF / Local NGOs	Cyclone Sidr affected coastal areas	40 children per classroom	10 years	Schools still in use	Classrooms, 1 outdoor activity/play/ extended class space, front veranda, office, WASH facilities	142 schools a 3-5 classrooms	30 days
C 9.0	CHINA	UNICEF / UNHCR	Wenchuan County, Sichuan Province	50 children per classroom	8-10 years	Not known	Classrooms, WASH facilities	100 classrooms	-
C 10.0	HAITI	UNICEF	Countrywide coverage in earthquake-affected areas (phase 1/2)	50 children per classroom (double shift)	Phase 1: 6 months, Phase 2:15 years, (Phase 3: 40 years)	Phase 1: canvas replacing of tent approximately 2 years, Phase 2: 25-30 years	Phase 1: Classrooms (tents), Administration offices, Chemical latrine, Phase 2: Classrooms (TLS), offices, WASH facilities, fence	Phase 1: 2000 tents +1 office Phase 2: 1200 TLS + 1 office	Phase 1: 2-3 days Phase 2: 21-60 days
C 11.0	HAITI	Plan International	Croix-des-Bouquets, Jacmel,	Approx. 50 children per classroom	20-30 years with proper maintenance	not known yet	Classrooms in twin module, WASH facilities , external play space	152 classrooms	15 days per double classroom
C 12.0	HAITI	Save the Children	Haiti, Port-au-Prince (PAP), Leogane and Jacmel	40 children per classroom	All timber frame : 5-10 yrs +, timber and masonry: 10 yrs +	not known yet	Classrooms, WASH facilities, playground, office, fence	45 schools with average of 4-6 classrooms	6-10 weeks
C 13.0	PAKISTAN	UNICEF	Flood affected areas	40 children per classroom	30 years	not known yet	Classrooms, Child friendly school furniture, WASH facilities, play space, fence	100 Transitional school structures with 3 classrooms	30 days

Main Construction Materials	Material Sources	Approx.Project Cost	Approx. Material cost/unit	Size of Units	Size of Construction Team	Construction Skill Required	Who Built the Facilities	Site Information
CGI sheets, timber, nails, cement, gravel and sand for flooring	Locally sourced	2,500 USD	1,750 USD	48sqm, 12sqm (Office)	6 construction workers	Carpentry and basic construction skill	Local craftsmen/ labour from IDP community	Secure land tenure main challenge
Local brick, bamboo, CGI sheets, precast concrete posts or local timber posts	Locally sourced	3,000-4,982 USD per school	2,040 - 3390 USD	48 sqm; school: 146 sqm,	4 skilled masons + 4 unskilled labourers , 1 carpenter	Masonry, RCC, carpentry skills	NGO, Local craftsmen, local community	Existing school grounds
Sandwich panels, steel frames, CGI sheets	Imported from within China	-	-	Twin classroom : 72sqm	4 workmen with knowledge of the assembly procedure	Assembly knowledge needed	Prefabrication by manufacturer, assembled by contractor	Remote mountainous area with difficult access
Phase 1: Imported tents, Phase 2: Steel structure of imported tents, cement, sand, gravel, steel reinforcement bars, concrete blocks or stone, CGI sheeting	Phase 1: imported Phase 2: locally sourced	Phase 1: 3,000 USD Phase 2: 175,000 USD per school	Phase 1: 2,200 USD (tent) Phase 2: 96,250 USD per school	Phase 1: 42/72sqm, Phase 2: 42sqm	Phase 1: 11(supervisor with 10 unskilled workers), Phase 2: 30 people (10 skilled workers and 20 unskilled)	Phase 2: Concrete + masonry + steel works, plastering, sanitary works	Phase 1: Community Phase 2: Local contractors + Community	Land ownership by Ministry of Education (public schools)
Reinforced concrete, timber structure, coated exterior grade plywood cladding, corrugated asphalt roofing	Predominately locally sourced	20-30,000 USD	10-15,000 USD	52sqm	8-10 crew members: 1 foreman , 3 carpenters with moderate experience;4-6 labourers	Basic carpentry skills required	Timber structure: local men (18-25 years old) trained by architect Concrete works (contractor)	Varied site conditions
Mountain stone foundations, concrete ring beams, cement blocks, timber structure and Zinc sheet roof	Locally sourced	12-18,000 USD	-	52sqm	20 people (1 x program manager, 1 x deputy program manager, 2-6 Engineers, 1-4 DRR mobilizers)	Basic carpentry skills required	Local contractor	Built within existing school grounds
Prefabricated insulated steel wall panels on steel substructure, masonry	local manufacturers and installed	35,000 USD	30,000 USD	40sqm	Monitoring: 2 internationals, 15 national staff (Professional Engineers and support staff) Construction: Contractor depending	Basic construction and assembly skills	Local contractors and suppliers	Varied site conditions



Photo: Carlos Vasquez, UNICEF

PAKISTAN

2010 / Flood / UNICEF 1

Agency:	UNICEF
Location:	Flood affected area in Pakistan
No. of users:	30 children
Anticipated lifespan:	3 months
Actual lifespan:	1 month
Facilities provided:	Only classroom structure
No. of facilities:	1 classroom
Construction time:	2 days
Main construction materials:	Wood poles, bamboo mats, tarpaulin roof

Material sources:	Locally sourced
Approx. project cost per unit:	500 USD
Approx. material cost per unit:	n/a
Size of units:	4m x 4.7m , 18sqm
Size of construction team:	2 people
Construction skill required:	Basic construction skills
Who built the facilities:	Local craftsmen
Site information:	No work was done to the site

Background

The 2010 Pakistan floods began in late July 2010, resulting from heavy monsoon rains in the Khyber Pakhtunkhwa, Sindh, Punjab and Balochistan regions of Pakistan and affected the Indus River basin. The floods were the worst floods in its recorded history experienced by Pakistan, affecting nearly 20 million people, over half of whom were children. According to World Bank estimates, the floods caused damage worth USD 9.7 billion, with about 1.9 million homes damaged and key social services - including water, sanitation, health care, and education - all suffered serious damage and will take years to restore. With about 10,000 schools damaged by the floods, and displacement affecting students and teachers, the education system came under severe strain. School enrolment and completion are likely to fall, especially for girls, as families keep their children at home due to economic reasons. Existing girls' enrolment is low due to low education of parents, poverty, lack of women teachers and inadequate sanitation facilities at schools.

The 2011 floods have had a compounded effect on an already weak system at all levels. This type of recurrent situation is becoming more the norm than the exception in many parts of the world.

Project Description

By December 2010 UNICEF and implementing partners had embarked on an effort to restore the education system as a way to bring a sense of normalcy to the communities affected by the floods. The massive amount of standing water and damaged roads made this task very difficult to deliver materials and resources in general. Local materials, craftsmen and construction systems were of low quality standards and very limited.

TLS Summary

Due to the very large number of children that needed to be covered by the initiative, there was insufficient time to properly plan and achieve the desired outcome.

Main results:

- There was a low level of coordination and planning between WASH and Education sector. The result was that most of the child-friendly spaces (CFS) did not provide access to essential water and sanitation services, placing children at risk.
- The limited access to materials resulted in many CFSs having a dirt floor or mud floor. Other spaces used extra tarpaulin to provide a "sealed" floor, with greater benefits to children.
- Most of all the CFSs were built on the existing low ground level, exposing the interior to floods in case of water movement or rains.
- Basic structural elements and designs were absent, creating very unstable structures. The improvements marked on the architectural drawings show very simple action points that would greatly improve the stability and quality of the structural system.
- The lack of maintenance instructions and activities had a great impact on the structures. The main timber posts deteriorated very fast. The treatment against rot is required.

Maintenance

Basic maintenance activities were not implemented, impacting the already fragile structures. Many spaces were used to house animals at night or as storage. These are fundamental issues that need to be avoided and maintenance instruction should clearly stipulate the use of spaces (the do's and don'ts). The recommendations on the drawings address these issues.

DRR

The site location is probably one of the most important steps when planning construction activities.

In this case, due to the massive extent of the floods the available spaces were limited. This site in particular was implemented within the existing damaged school grounds and therefore with a good degree of safety and community oversight. In terms of the material selection, non-flammable materials are always better than highly combustible thatch or bamboo mats. Preventing fires and guaranteeing children's safety must be at the centre of the design and material selection process.

Improvements

- Improvements to structural stability and wall substructure with cross bracing
- Increase to 1sqm per child
- Improvements to roof structure and tarpaulin cover, as well as roof overhang for shading
- Raising floor level from ground level to protect from flooding, sealing internal floor by screed/tarpaulin and floor mats
- Including additional entrance/exit for emergency
- Including accessibility ramp



Photo: Carlos Vasquez, UNICEF

Impact on schools



Photo: Carlos Vasquez, UNICEF

Unsafe and unhealthy latrines within camps



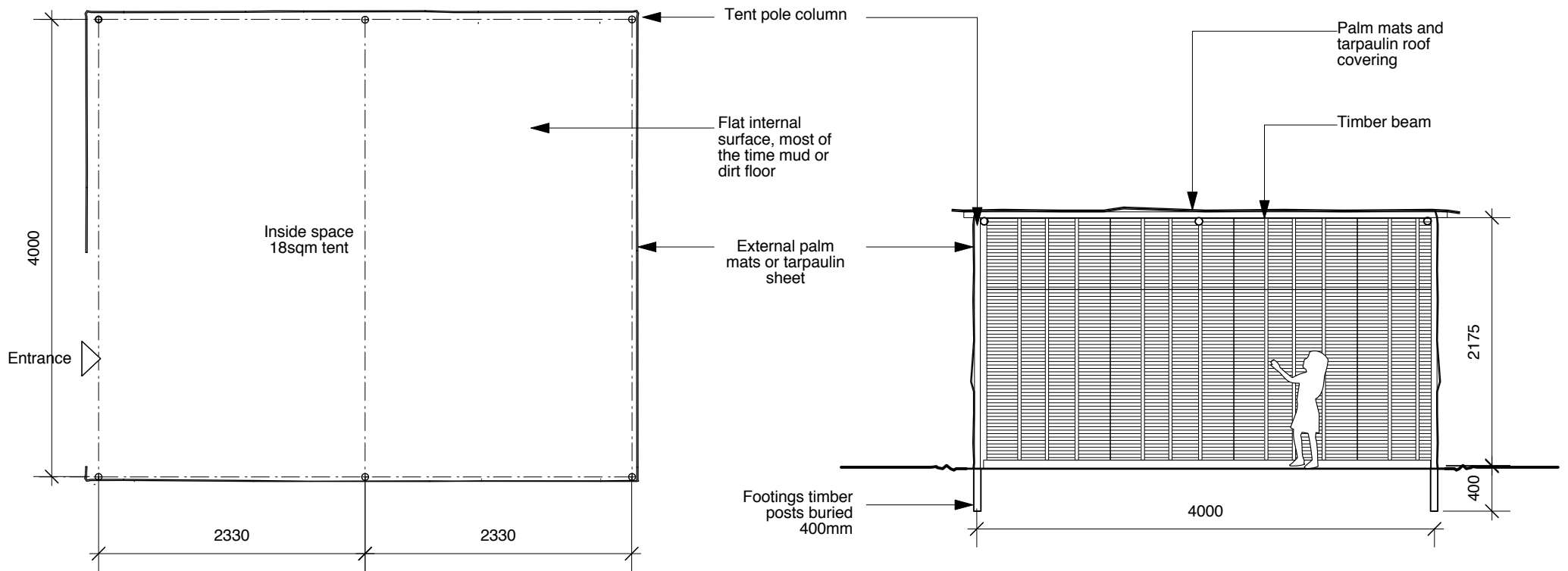
Photo: Carlos Vasquez, UNICEF

Interior of TLS with mud floor



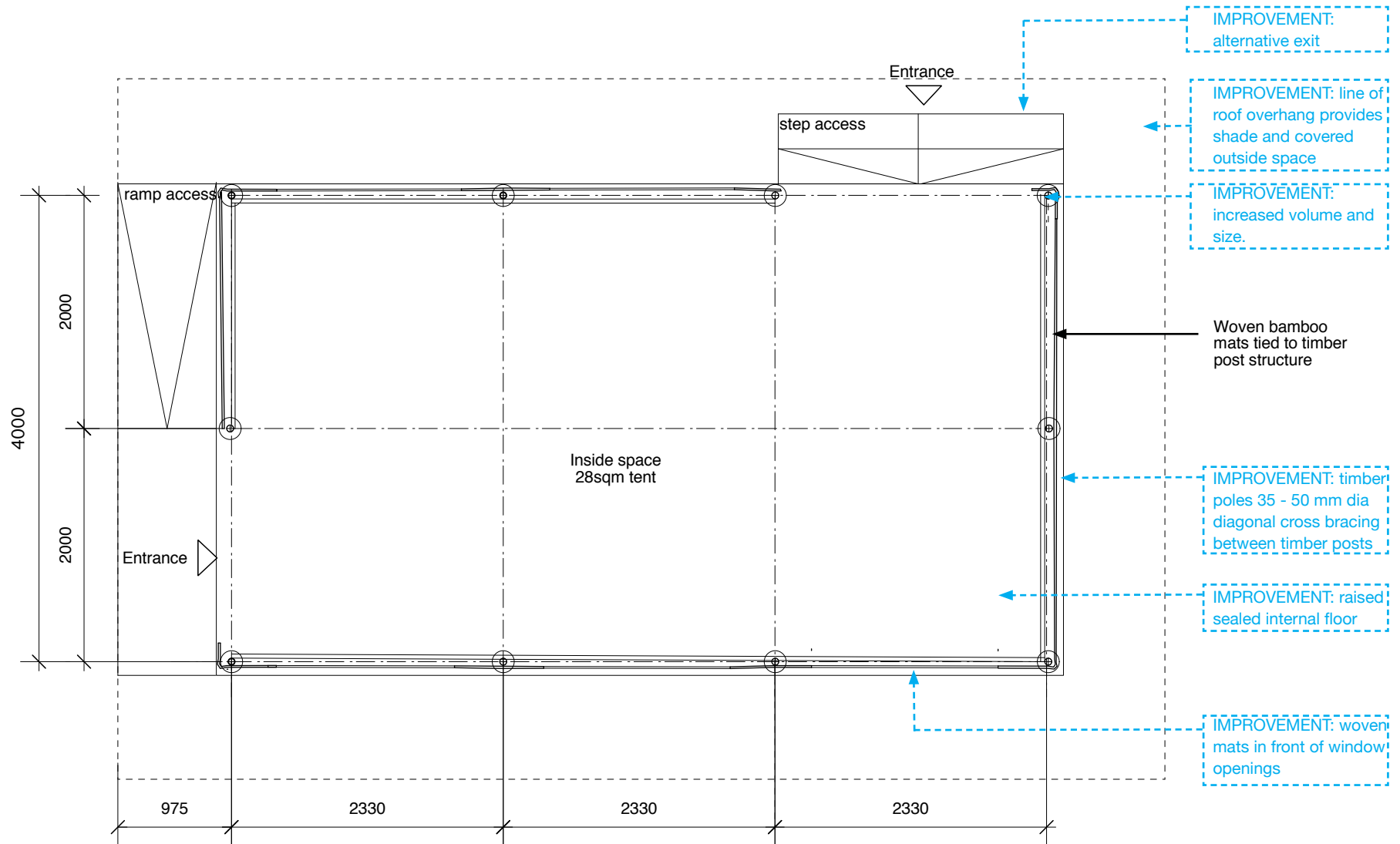
Photo: Carlos Vasquez, UNICEF

Internal view of bamboo clad structure with tarpaulin floor

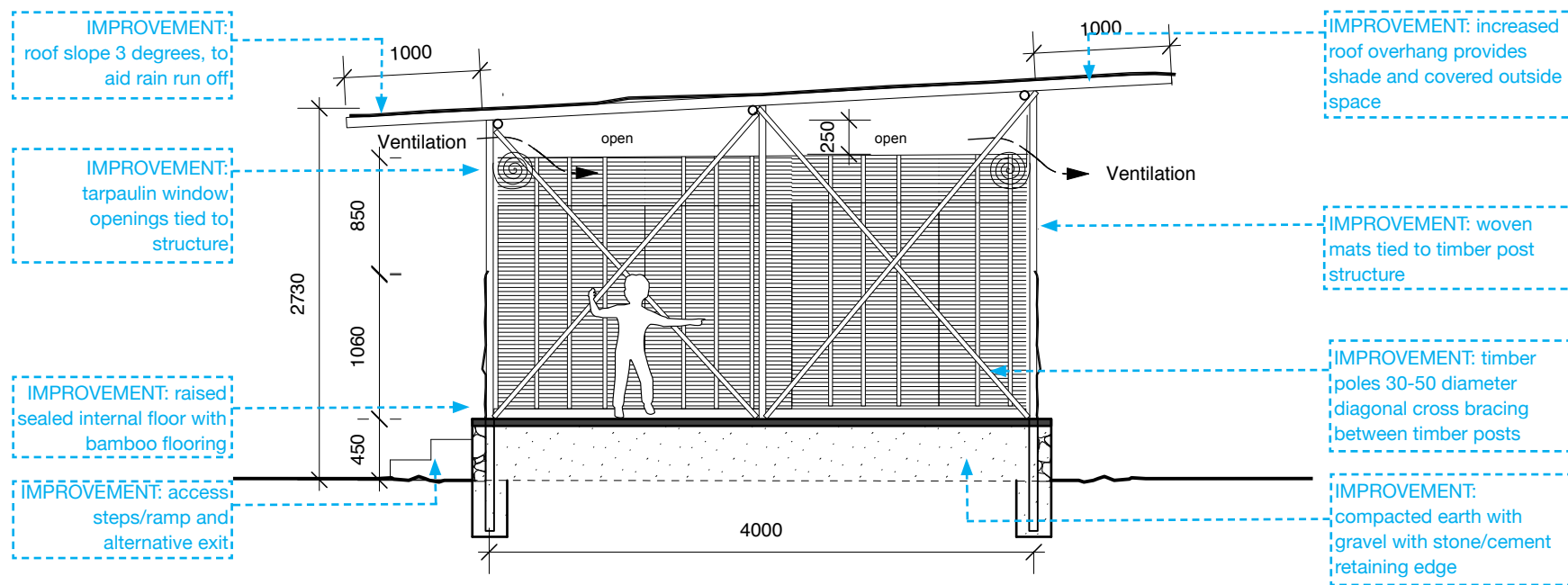


Scale 1:50

Proposed Ground Plan



Scale 1:50



Scale 1:50

Quantities for one unit of 28sqm		
Elements	Unit	Quantity
Foundations		
Compacted earth and gravel	m ³	13
Concrete	m ³	1
Walls		
Timber pole column	no.	10
Woven bamboo mats (2330x2000mm)	no.	3
Woven bamboo mats (2330x1000mm)	no.	5
Dagnoal cross bracing timber poles	no.	16
Bamboo blinds window (2330x1000mm)	no.	5
Roof		
Timber beam (7000mm)	no.	3
Timber beam (6000mm)	no.	4
Timber beam (9000mm)	no.	3
Tarpaulin sheets roof	m ³	54

Section C 1.0

Field Notes:

This is space for individual field notes, documentations and observations.



Photo: UNICEF Rwanda, Luca Ginoulhiac

External view of TLS in Rusizi

RWANDA

2008 / Earthquake / UNICEF

Agency:	UNICEF / Rwanda Office in collaboration with local district government
Location:	Earthquake-affected areas of Rusizi and Nyamasheke district
No. of users:	50 children per classroom, (double shifting 80-100 per classroom) total children number 17000
Anticipated lifespan:	1 year
Actual lifespan:	Lasted for more than 1 year, the tarpaulin was damaged by the sun, required replacing
Facilities provided:	Classrooms, portaloos latrines (mobile toilets), drinking water and water storage (by WASH section)
No. of facilities:	212 classrooms

Construction time:	4-6 days (materials on site) per classroom, total 1,5 months for 212 classrooms
Main construction materials:	Wood poles structure with tarpaulin covering and wooden window shutters
Material sources:	UNICEF provided tarpaulin, timber poles locally sourced
Approx. project cost per unit:	550 USD (including labour cost, transport, indirect costs)
Approx. material cost per unit:	390 USD
Size of units:	Classroom size 8m x 6m, 48sqm
Size of construction team:	Crew of 6 workmen per classroom, total: 30 carpenters, 25 labourers, 2 technicians, 2 supervisor
Construction skill required:	Basic timber construction skills
Who built the facilities:	Local carpenters and unskilled community members were trained by American Refugee committee (ARC) to built classrooms
Site information:	Various sites within existing different school grounds, sites are predominately on hilly locations

Background

On Sunday 3rd February 2008, a series of earthquakes struck Rwanda and Democratic Republic of Congo (DRC). The most powerful earthquakes occurred within hours of one another with magnitudes of 6.1 and 5.0 respectively. It was followed by aftershocks of magnitude 5 on Monday 4th February. The earthquakes affected mainly two districts, Nyamasheke and Rusizi, Western Province, which are at the border of DRC, Bukavu and along Lake Kivu.

As churches, homes and buildings, including one hospital collapsed. Figures provided by the Rwandan Disaster Management Task force (DMTF) indicate that 37 people died, 643 injured, including 367 traumatized. Individual houses were also destroyed in these two districts, leaving 1,201 families without shelter (7,206 people including 5,000 children). These last days, heavy rains have contributed to the destruction of additional houses.

Twenty primary schools are reported to be affected in both districts, which affect a total of 30,000 children. Four secondary schools were damaged. With regard to primary schools, one was destroyed and 19 have suffered structural damage. The Government reported that 134 classrooms need to be rebuilt and 240 can be rehabilitated. All affected primary and secondary schools have been closed.

(Source: UNICEF Rwanda – Request for emergency programme funds – 10 February, 2008)

Project Description

The main objective of this project was to facilitate the resuming of education at the earliest date possible with two months after the earthquake in May 2008. All schools had been closed after the earthquake and classes discontinued.

Soon after the events UNICEF promptly intervened by providing tents followed with the construction of temporary classrooms and Early Childhood Development (ECD) facilities to allow in the short term the normal development of lessons in damaged primary schools while finalizing a project proposal presented to the Government of Japan. This project envisaged the sustainable reconstruction and rehabilitation of Educational and Health Infrastructures through an integrated approach focused on capacity building and community empowerment. The Government of Japan had accepted to finance the construction and rehabilitation activities with a grant and is part of the current child-friendly schools (CFS) construction and rehabilitation activities that are led by the government of Rwanda in partnership with UNICEF. In some instances the transitional learning spaces were in use till 2010-11 while permanent child-friendly school construction was underway.

To give emergency assistance to the affected district governments UNICEF provided technical assistance through 4 technical experts to support in the establishment of transitional learning spaces constructed from locally sourced timber poles and plastic sheeting. As well as help the local district governments with the mobilization and training of local carpenter and provide tarpaulin and the required finances. For each of the damaged schools, the American Refugee Council (ARC) trained 25 local carpenters by building with them one classroom as demonstration. The carpenters then completed the construction of the school under the supervision of the technicians. In some cases where the material was readily available the construction of 7 primary schools classified as priority was completed within 2 weeks. To aid the fast construction of the TLS the already trained carpenters were employed as trainers for other sites. A monitoring procedure was established where the ARC Karongi Camp Manager visited the sites twice per week to give orientation and help solving problems.

As the TLS project was integrated within a larger countrywide child friendly construction project it was important to find appropriate temporary sites that would allow for the permanent construction works to take place without endangering the continuation of classes and the children's safety.

In addition to the classroom construction, the WASH section provided plastic mobile latrines (100 units of portaloos) for boys and girls, safe water storage facilities (30 units of 10m³) and rain water harvesting.

TLS Summary

The timber pole construction of the classroom structures is based on the Rwandese vernacular building technology, the readily availability of construction materials and the necessary construction capacity in the local communities. The classroom structure is 6m wide and 8 m long rectangular space of 48sqm in total accommodating approximately 50 children per class. The overall structure for roof and walls is made of 75m-100mm locally untreated sourced timber poles that are nailed together into a lattice framework of approximately 800mm spacing. The timber poles are dug into the ground approximately 600-800mm. No foundation has been used. The whole TLS timber pole structure is covered by tarpaulin sheeting for roof and walls and nailed to the main timber poles. The TLS has window opening to both long sides with timber shutters and a lockable timber door. The existing classroom furniture was used within the TLS.

Maintenance

Due to the fact that some TLS were used for a few years until permanent structures had been completed, the plastic sheeting was destroyed by the sun after one year and needed replacement. It is important to mention that better quality tarpaulin sheeting was required.

In addition the site drainage and water harvesting require maintenance especially before and during the rainy season.

DRR

The site location is one of the most important considerations, as most sites in Rwanda are on slopes and prone to mud slides after heavy rains.

Challenges

- Sourcing the required timber poles at short notice
- Short time available before reopening of the school
- Availability of good quality plastic sheeting at short notice

Improvements

- Consideration to raising the internal floor level from the ground level to prevent flooding during rainy season
- Sealing the internal floor through reuse of materials from damaged classrooms, heavy duty tarpaulin sheeting, or gravel/ screed flooring (more durable)
- Drainage channels around the TLS to allow site drainage on sloped sites
- Enlarge the openings to allow better ventilation within tarpaulin structure, or high level openings at eaves to encourage hot air to be drawn out
- Include additional exit door for emergency escape
- Extra cross bracing of lattice wood pole structure, especially at corners to be more earthquake resistant



Photo: UNICEF, Rwanda

Wooden pole lattice structure, TLS under construction



Photo: UNICEF, Rwanda, Luca Ginoulhiac

Demolishing of TLS after child-friendly permanent school to the left was completed



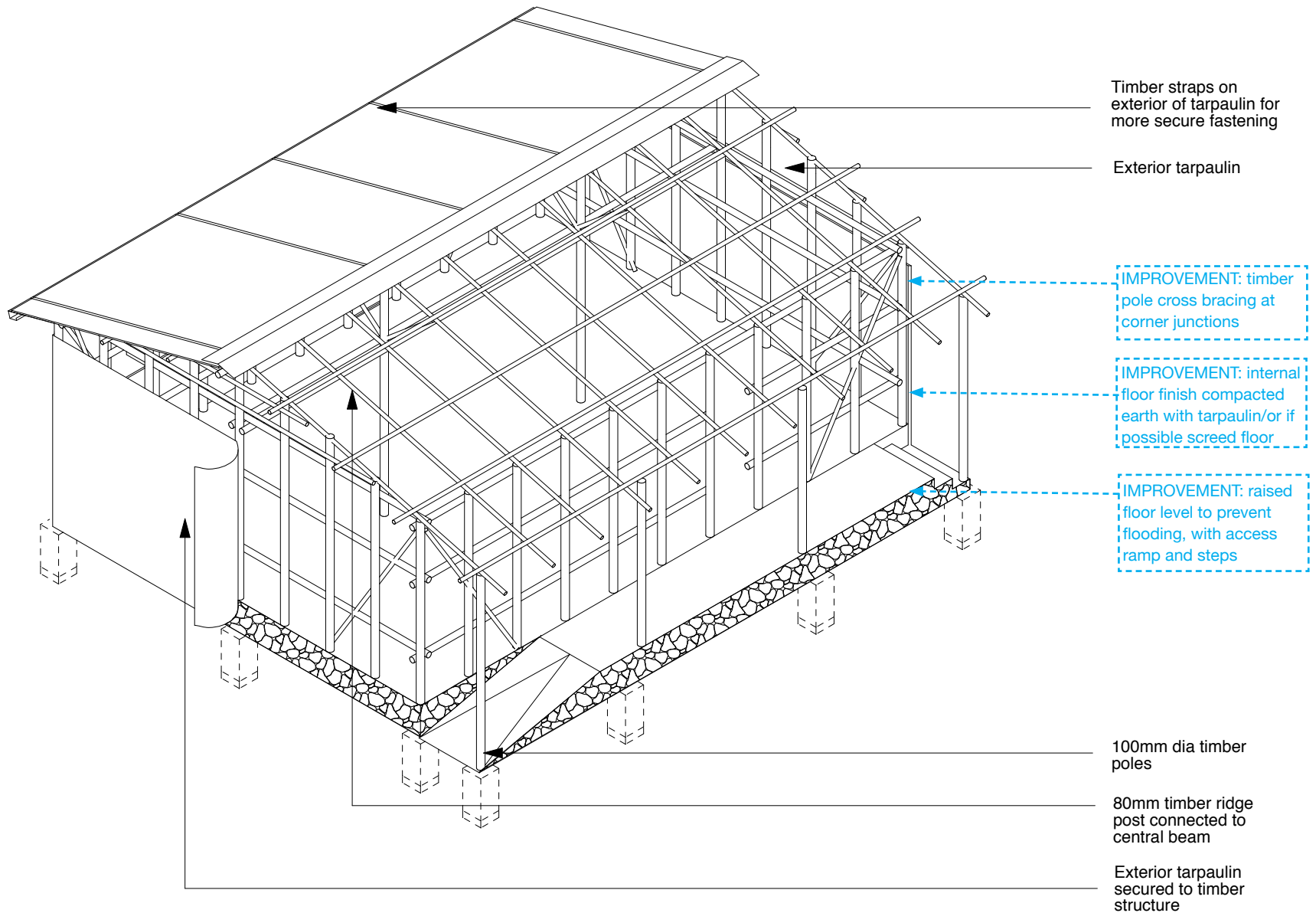
Photo: UNICEF Rwanda, Luca Ginoulhiac

Internal view of TLS

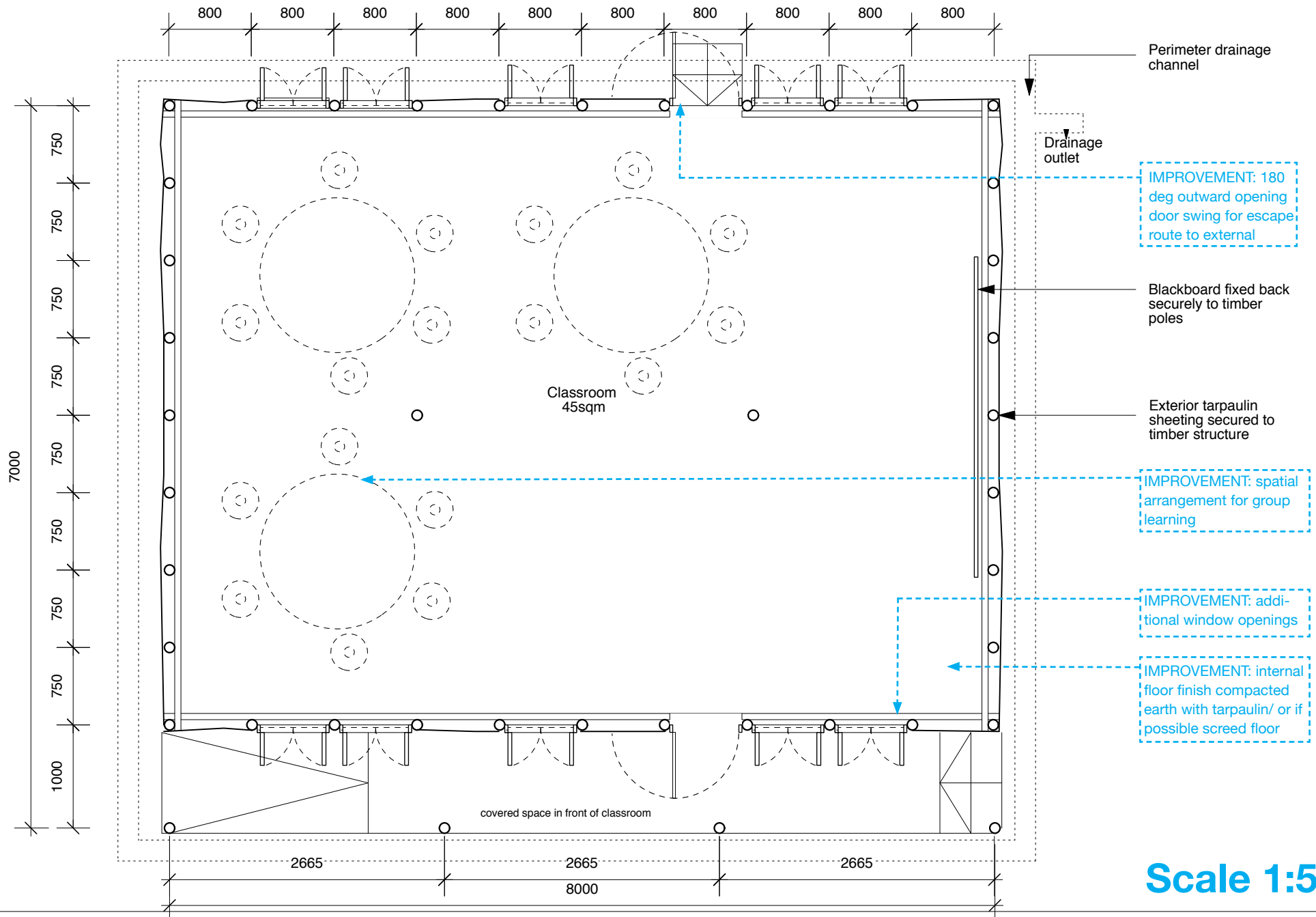


Photo: UNICEF Rwanda, Luca Ginoulhiac

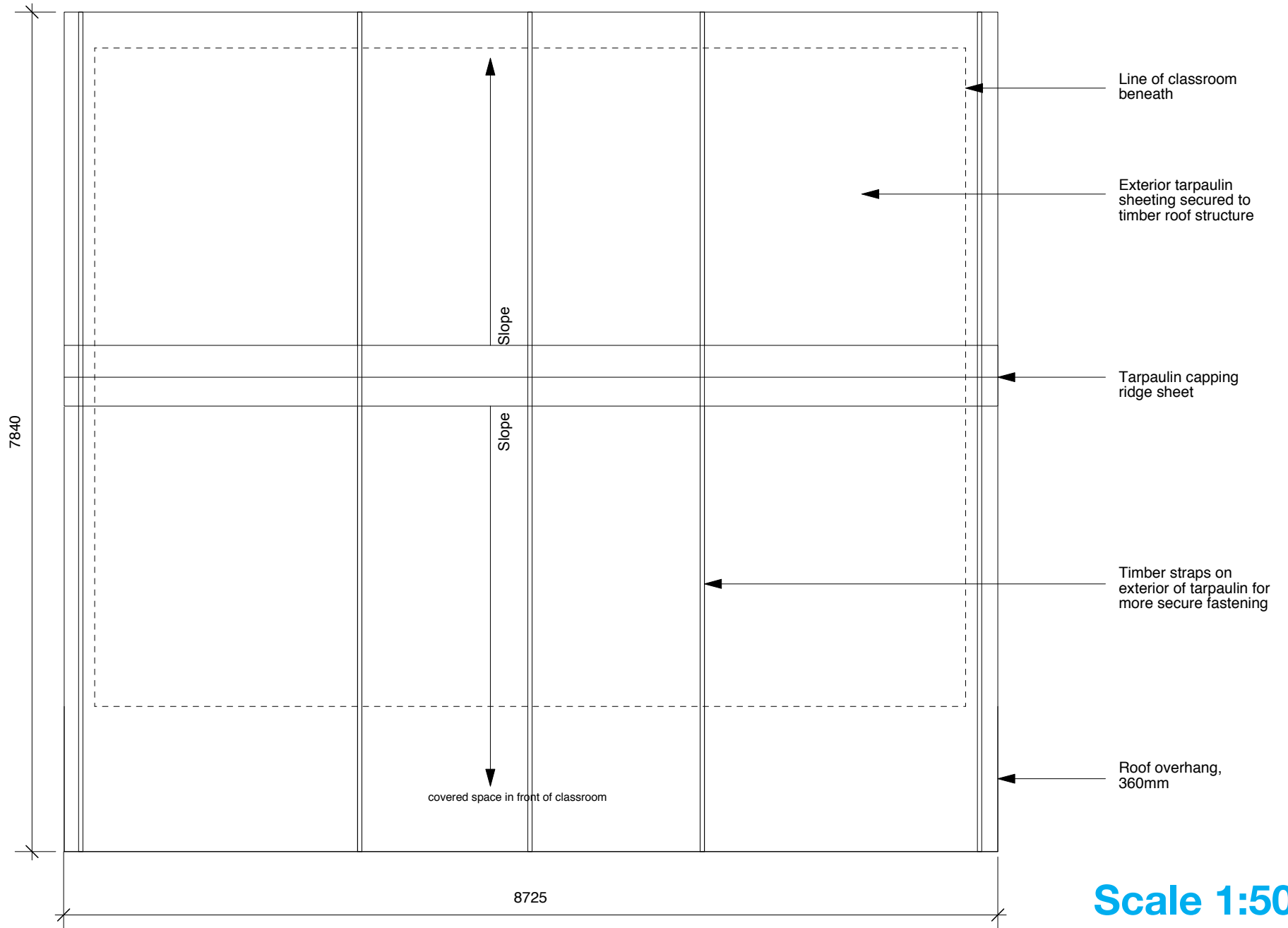
Earthquake damage on school buildings



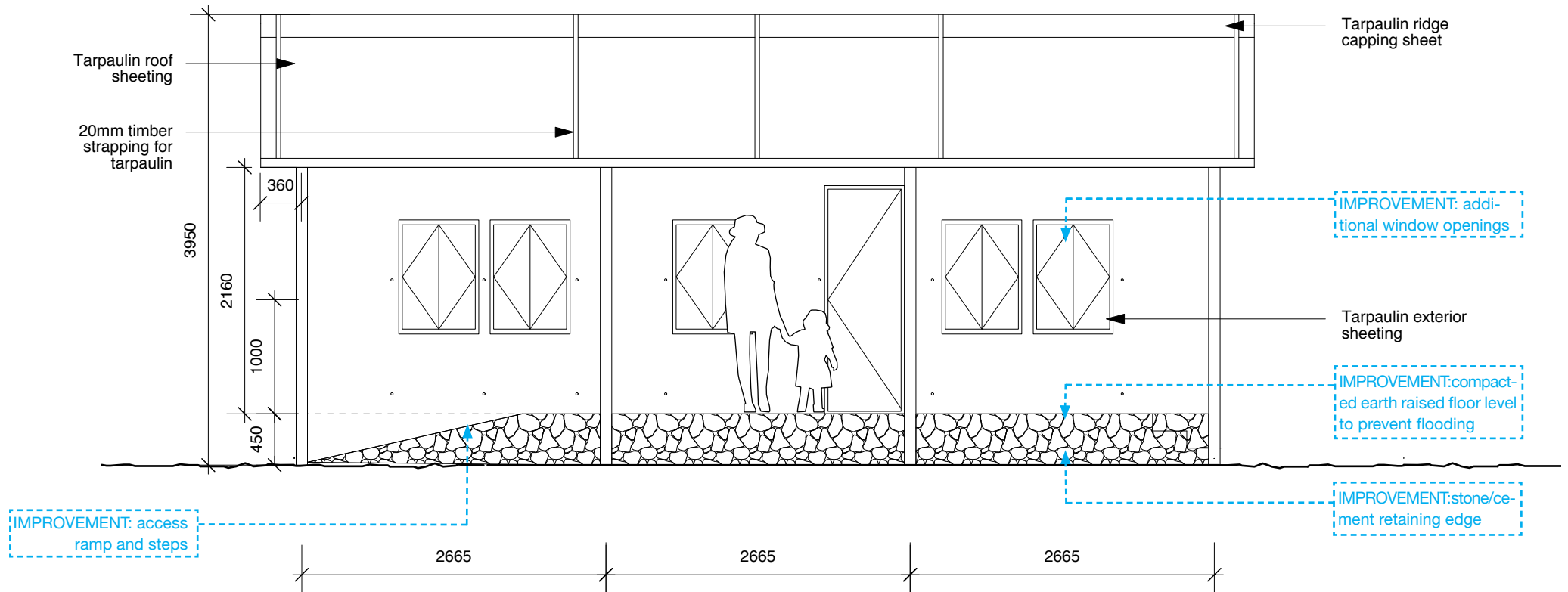
Note: drawing not to scale, for illustrative purpose only



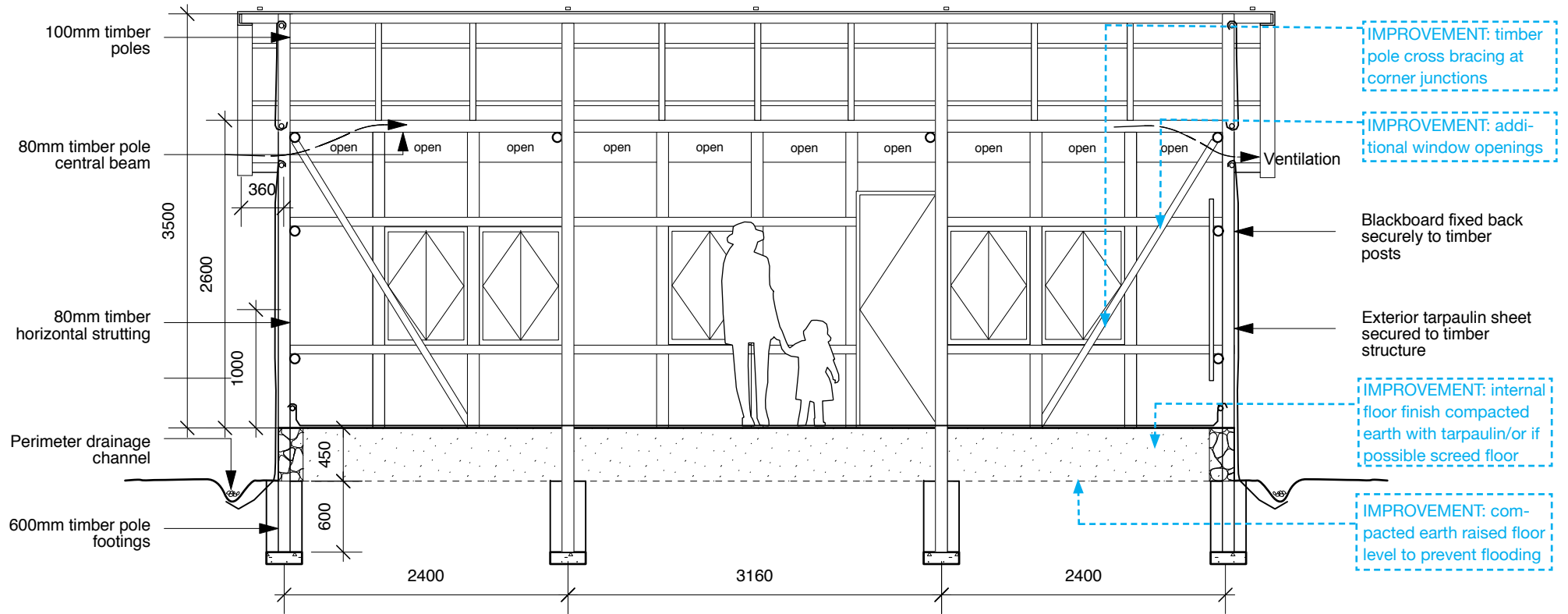
Scale 1:50



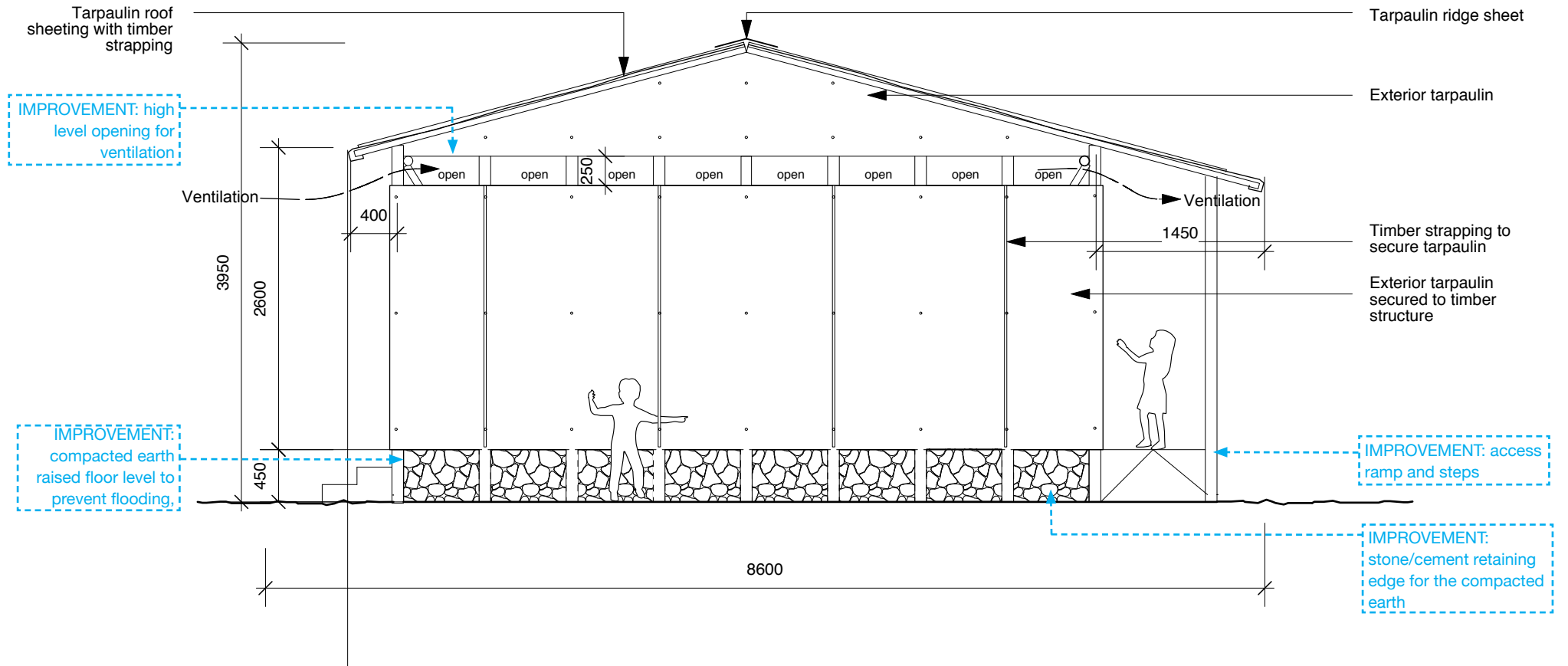
Scale 1:50



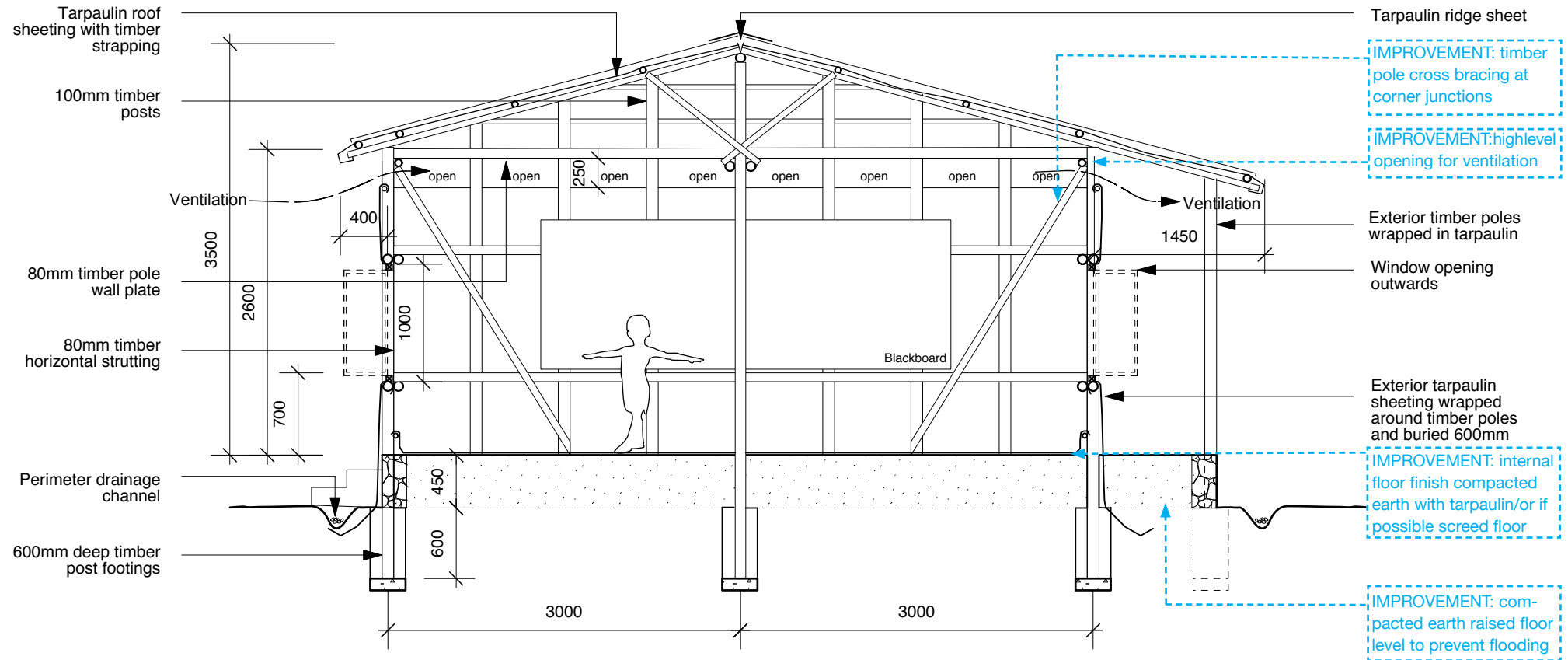
Scale 1:50



Scale 1:50



Scale 1:50



Scale 1:50

Quantities for single unit of 45sqm		
Elements	Unit	Quantity
Foundation		
Compacted earth	m ³	35
Stone/ cement (for wall)	m ³	1.5
Stone (for footing)	m ³	0.2
Tarpaulin sheeting for floor	m ²	50
Wall		
100mm timber poles (5200mm)	no.	4
100mm timber poles (3400mm)	no.	4
100mm timber poles (3000mm)	no.	22
100mm timber poles (3300mm)	no.	4
100mm timber poles (3500mm)	no.	4
100mm timber poles (3700mm)	no.	4
80mm timber horizontal strutting (6100mm)	no.	4
40mm timber horizontal strutting (4600mm)	no.	2
40mm timber horizontal strutting (2400mm)	no.	2
80mm timber wall plate (6100mm)	no.	2
80mm timber horizontal strutting (2500mm)	no.	4
80mm timber horizontal strutting (4900mm)	no.	4
80mm timber wall plate (8000mm)	no.	2
60mm timber pole cross bracing (2900mm)	no.	8
Planks for doors & windows	m ²	7
Timber for doors & windows	m	40
Triplex for black boards	m ²	4.5
Reinforcing laths for black boards	m	10

Tarpaulin exterior sheeting	sqm	95
Timber strapping for tarpaulin sheeting (2300mm)	no.	8
Roof		
80mm timber central beam (7100mm)	no.	2
80mm timber ridge beam (8700mm)	no.	1
60mm timber rafter (4300mm)	no.	11
60mm timber rafter (4600mm)	no.	11
60mm timber purlin (8700mm)	no.	7
60mm timber truss cross bracing (900mm)	no.	4
Tarpaulin ridge capping sheet	m ²	5.5
Tarpaulin roof sheeting	m ²	81
Timber strapping for tarpaulin roof sheeting	m	45
Others		
Roofing nails	box	15
150mm ordinary nails	box	6
120mm ordinary nails	box	8
100mm ordinary nails	box	5
80mm ordinary nails	box	5
60mm ordinary nails	box	3
50mm ordinary nails	box	3
Black paints (for black boards)	litre	2
Fuel for implementation & supervision	litre	5
Nylon strings		

Section C 2.0

Field Notes:

This is space for individual field notes, documentations and observations.



Photo: UNICEF, Madagascar

External view of completed TLS in Saranindona

MADAGASCAR

2008 / Cyclone / UNICEF

Agency:	UNICEF
Location:	Saranindona in Antsiatsiaka
No. of users:	12,500 students to return to school, approx. 50 children per classroom
Anticipated lifespan:	6 months, but sometimes the tarpaulin has to be changed each 3 or 4 months.
Actual lifespan:	Remained in place since 2008, eventually upgraded by local materials for the roof and woven bamboo for the walls
Facilities provided:	In some regions with severe flooding and contaminated water WASH facilities, including latrines, hand wash points, drinking water; "School in a Box" and "Recreational kit", school furniture

No. of facilities:	250 in 2 months
Construction time:	8 hours
Main construction materials:	Wooden poles and pegs/tarpaulin sheets/galvanised steel wire
Material sources:	Locally sourced, Tarpaulin (250 gr/m ²) imported
Approx. project cost per unit:	174 USD (no overheads as community constructed)
Approx. material cost per unit:	174 USD
Size of units:	48sqm
Size of construction team:	Approximately ten community members, including one foreman
Construction skill required:	Basic carpentry skills and basic construction skills
Who built the facilities:	Local craftsmen and community/school community members
Site information:	Within school grounds at safe distance from damaged classrooms, located not on reconstruction allocated site

Background

In February 2008, Cyclone Ivan hit the mainland of Madagascar and left more than 200,000 people homeless. It destroyed more than 2,000 classrooms. There was great need to provide immediate temporary education infrastructure for 40,000 children whose education was suspended. Over 60% of the affected schools were located in rural areas, which made access difficult by the subsequent flooding. As many as four cyclones strike Madagascar each year, damaging or destroying on average 1000 classrooms and disrupting the education of about 150,000 students.

Project Description

The project aim was to design effective, low-cost and easily transportable emergency educational units to remote rural areas where the flooding made transportation of any structures or bulky material very difficult and expensive (Saranindona in Antsiatsiaka, 40km by car, 15km by canoe and 23km walking). Instead of transporting a traditional tent (400kg each), the trained local technicians have to transport just 28kg. UNICEF key criteria for building these transitional learning spaces including the following aspects: to be erected very quickly, ease in transport, maximise use of local materials, strong enough to withstand a second cyclone, cost effective, maximum community participation and community maintenance. Therefore, UNICEF Madagascar erected tents from locally available materials (wooden poles), which enabled the quick assemble of these temporary structures by ten community members within approximately eight hours. The plastic sheeting cover (tarpaulin 250gr/m²) and other accessories that can't be found in the field, such as nails, cord and galvanised steel wire, were provided by UNICEF. After two months 250 transitional learning spaces had been installed, ensuring the return of almost 12,500 students to school.

TLS Summary

The temporary learning tent is based on the circus tent concept. It is a lightweight timber pole framed structure that measures 6m x 8m on plan and is 3.7m in height to the ridge beam and 2.1m to the eaves. The TLS consists of five pentagonal frames made from 3" thick and 4m long wooden poles fastened together by nails and galvanised steel wire of three mm thickness. Steel wire straps are used to tense the overall structure together and it is secured to the ground by wooden or steel stakes. Each structural member is stiffened by diagonal tensioning of three mm galvanized steel wire and the frame joints are stiffened through triangle corner bracing for cyclone resistance. The roofing plastic sheeting (tarpaulin 250gr/m²) provides cover and is fixed by nails to the timber pole frames. There is a continuous opening along both long sides of the tent to provide cross-ventilation and lighting. The openings are protected from rain or direct sun by tarpaulin flaps.

To facilitate a fast construction process the community participated in all activities, such as transportation of the materials (tarpaulin and accessories) to the school areas, approximately 60kg, erection of tarpaulin tents with the technical support of trained local construction/emergency teams, purchase of wooden poles (50 poles of 4m x 3" thickness), eventual disassembly of the tarpaulins once damaged or destroyed classrooms/schools have been rebuilt, training of other communities and maintenance practices.

Maintenance

The structures were locally maintained. The tarpaulin requires changing every three to four months. The community decided to upgrade with improvements of timber flooring (from damaged classrooms) and palm mat walling and local materials for roofing to improve the temperature inside the structure.

DRR

The main aspect to be considered is the location on higher ground if possible to protect the structure from repeated flooding.

Challenges

- Giving clear instructions to the community of sourcing the right length, thickness and quality of poles for the structure.

Improvements

- A double layer of tarpaulin for the roofing allows a ventilation gap to reduce the internal temperature and cool the space. This design is particularly suitable for hot, dry, windy and dusty climates.
- Consideration should be given to include a sealed floor for children's health reasons. In some cases the community installed reclaimed wood flooring from the damaged classrooms
- Consideration to locate the structure on higher grounds (450mm) to protect from flooding



Photo: UNICEF, Madagascar

Existing vegetation providing shadow



Photo: UNICEF, Madagascar

Protection from rain (provide ventilation)



Photo: UNICEF, Madagascar

Structure with wooden poles and pegs



Photo: UNICEF, Madagascar

Double layer of tarpaulin can be introduced inside to provide insulation

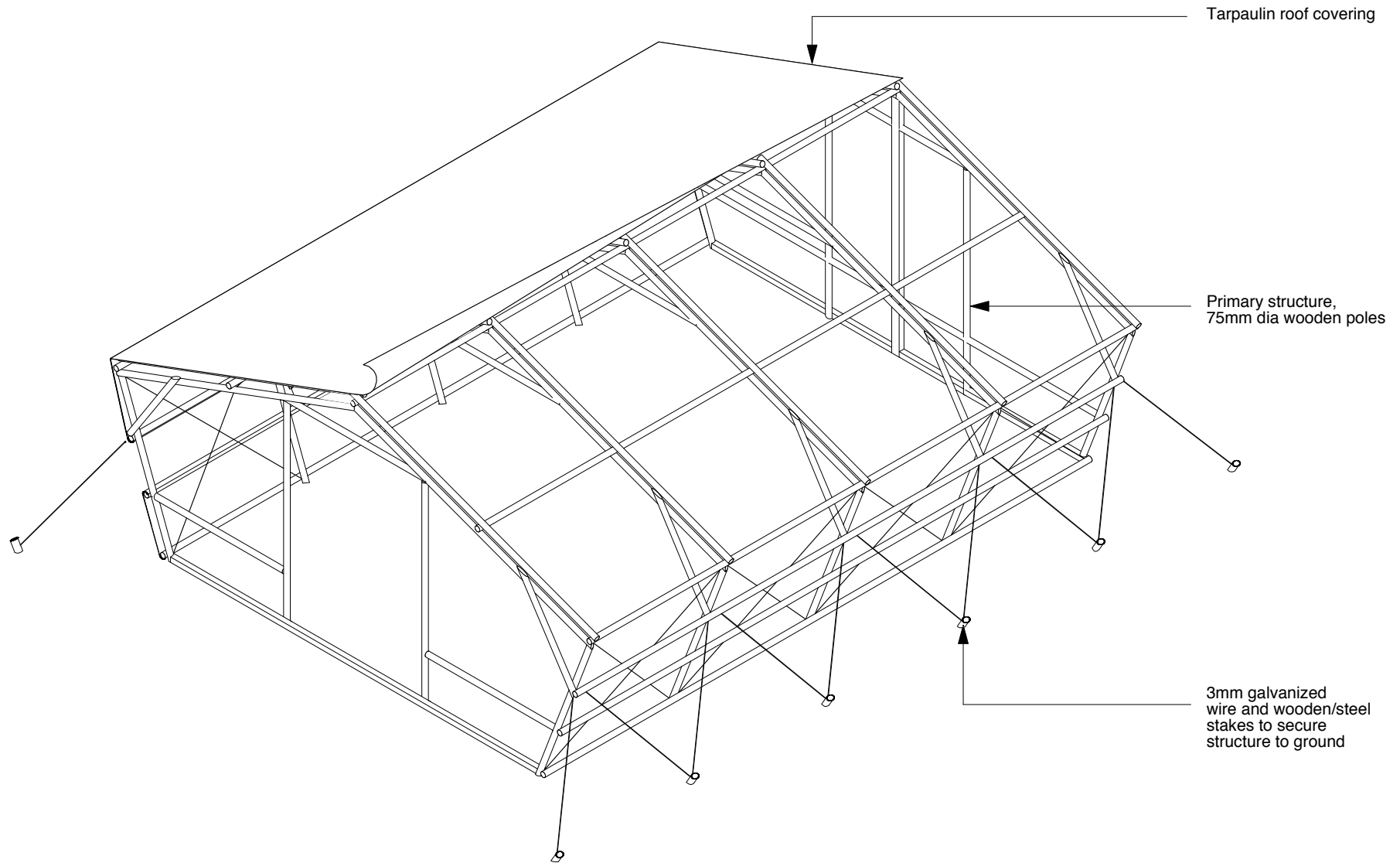


Photo: UNICEF, Madagascar

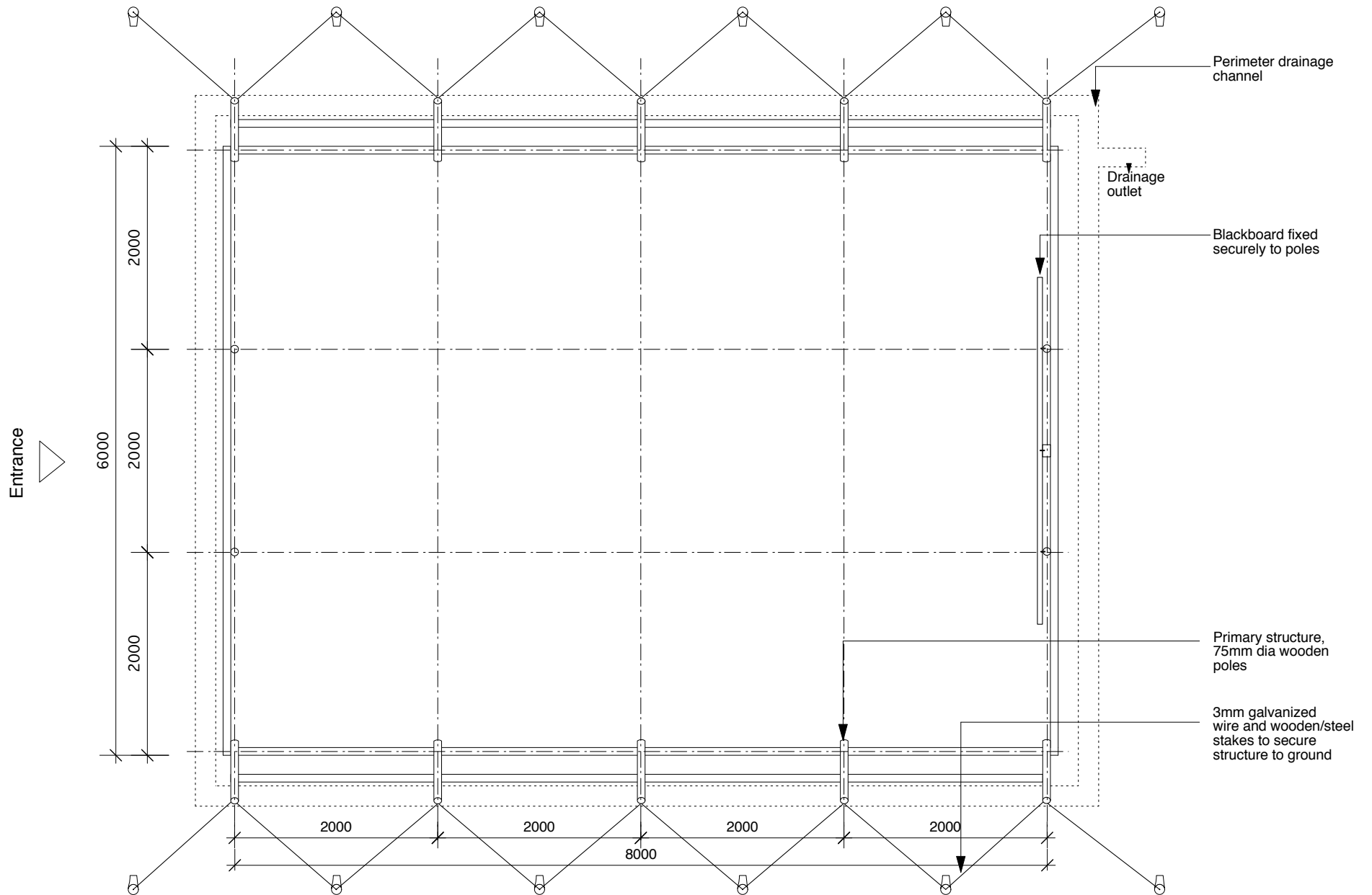
Large openings to guarantee good ventilation



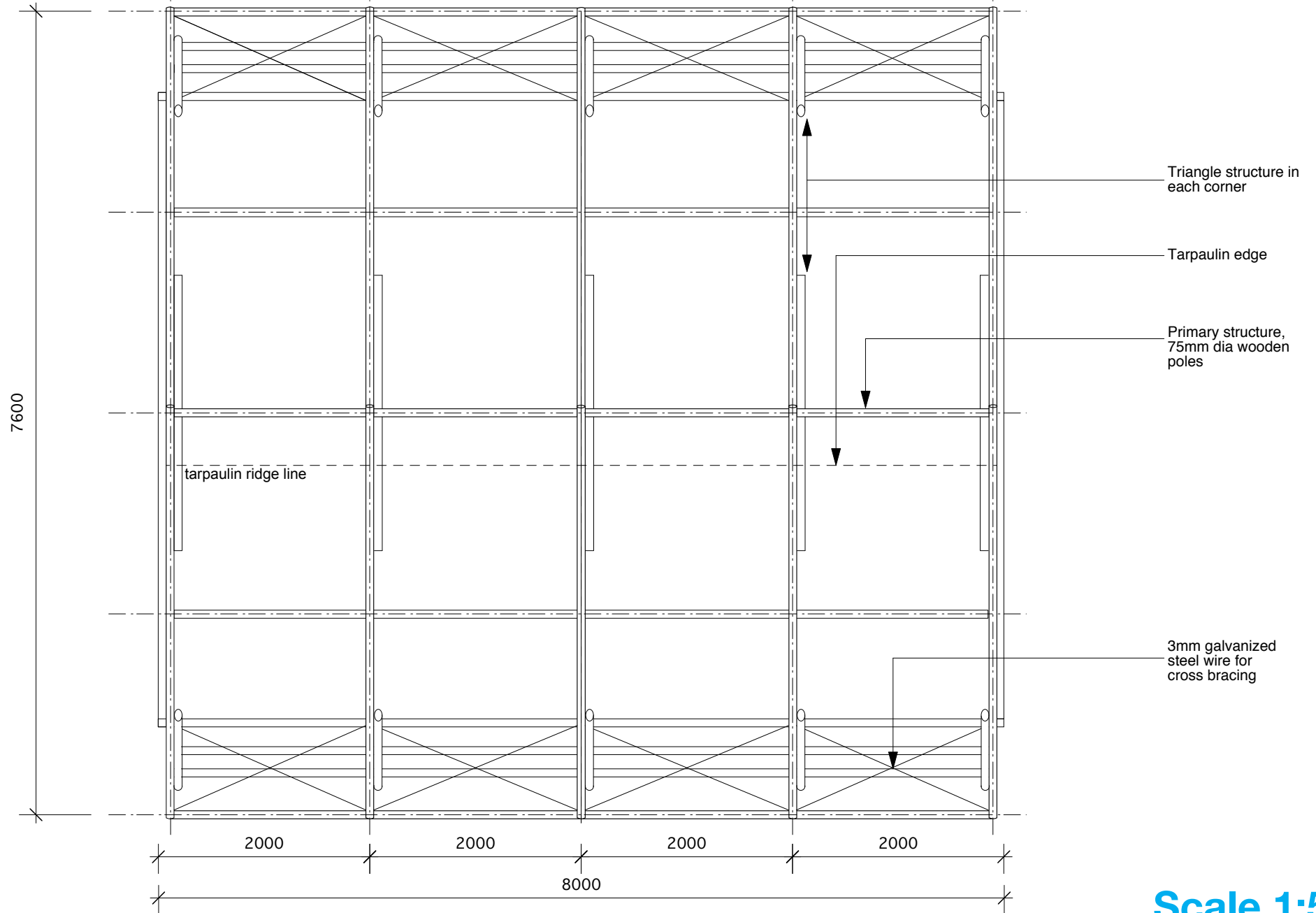
Photo: UNICEF, Madagascar



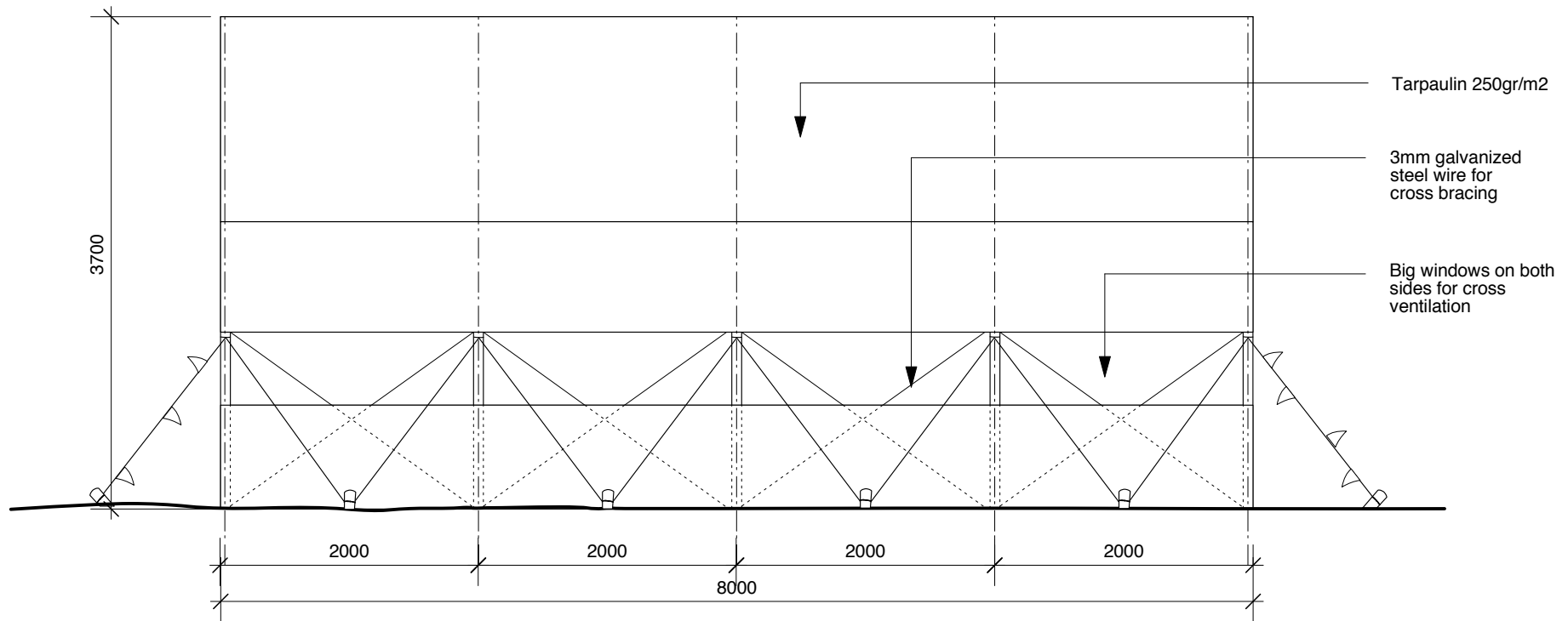
Note: drawing not to scale, for illustrative purpose only



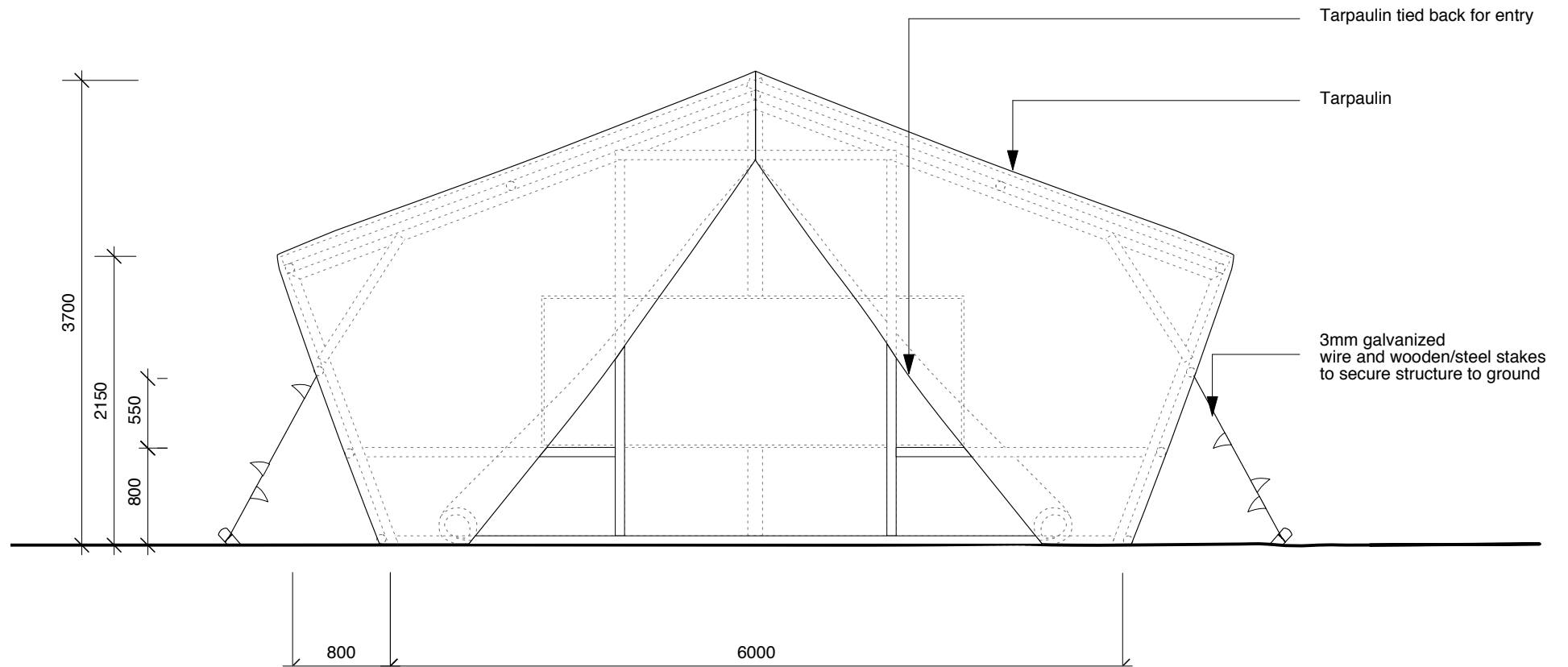
Scale 1:50



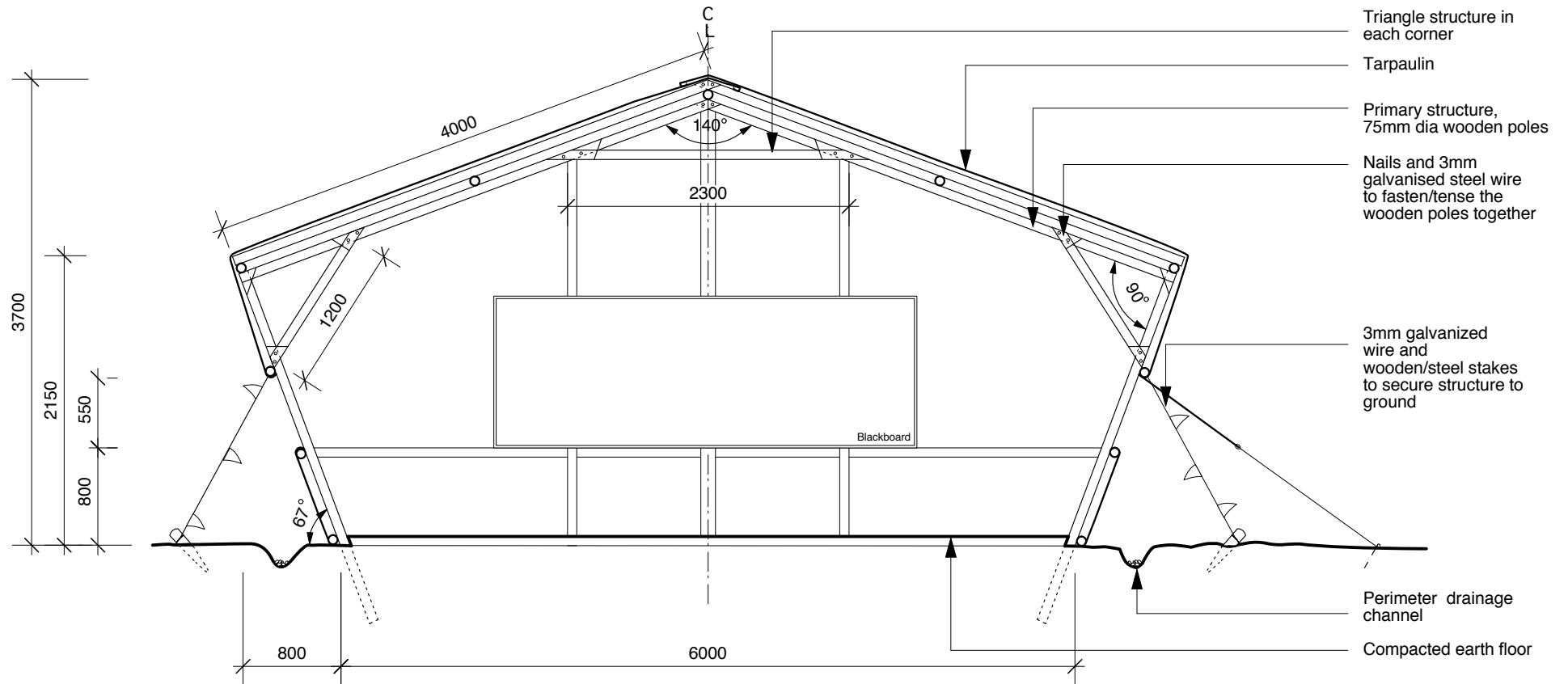
Scale 1:50



Scale 1:50



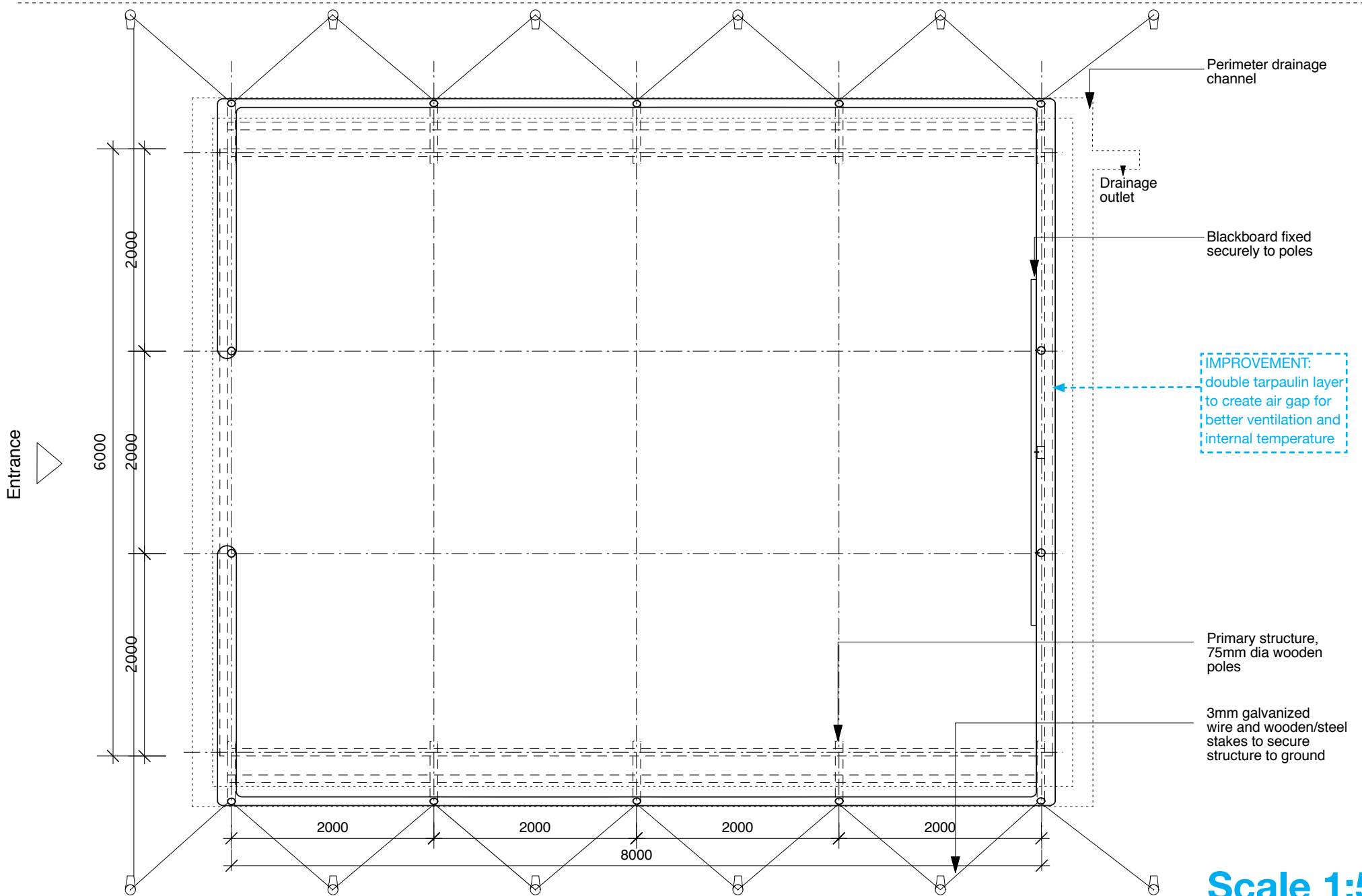
Scale 1:50



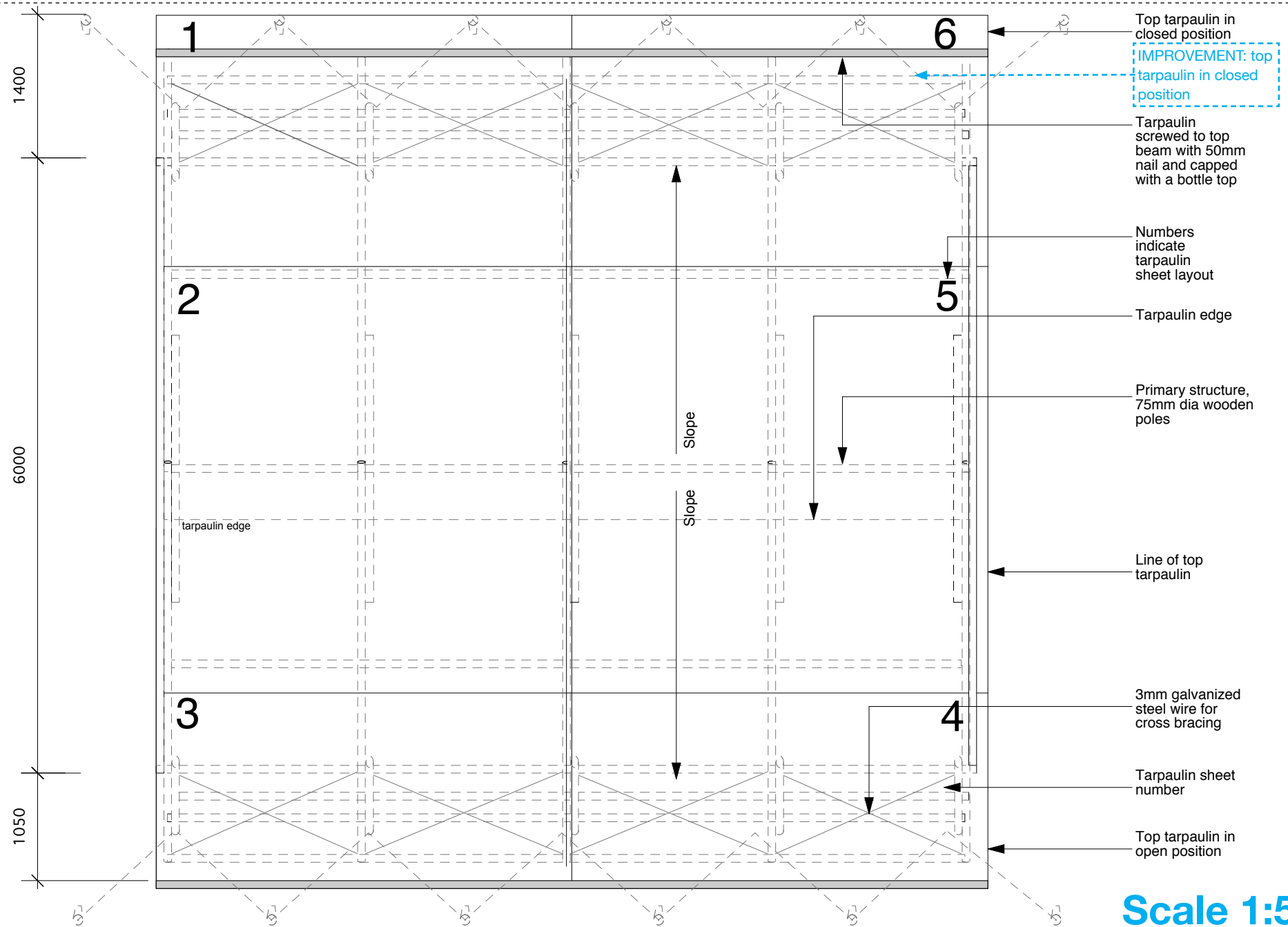
Scale 1:50

Quantities for single unit of 48sqm			
Element	Unit	Quantity	Utilisation
Primary Structure			
80mm wooden poles (8.00m length)	no.	11	The tent's structure is in wood, so that once the tarpaulins deteriorate with time (3/4 months) the community can build walls and roof in local materials. Wooden poles come in 4m lengths
80mm wooden poles (4.14m length)	no.	20	
80mm wooden poles (3.57m length)	no.	2	
80mm wooden poles (3.08m length)	no.	4	
80mm wooden poles (3.07m length)	no.	10	
80mm wooden poles (2.30m length)	no.	5	
80mm wooden poles (2.21m length)	no.	4	
80mm wooden poles (1.20m length)	no.	10	
Wooden stakes	no.	12	To improve the adherence of nails to the tent and expand the area of the nail with less chance of tearing of the tarpaulin. Can be collected in drinking points that sell refreshments (attached to the fridge there is a collector of caps)
Aluminium bottle caps	no.	100-150	
Basic Tarpa Kit			
Tarpaulin (5.0mx4.0m)	m ²	10	To cover roof, walls
Sawing needle for shoes	no.	4	To saw 4 tarpaulin sheets together folding the sides in 4 so that water will not pass through, and to form the tent roof 10m x 8m. 4 persons needed. Good opportunity for women to participate.
3mm galvanised steel wire	kg	10	To secure poles, and the structure
Plastic rope (100mx3mm)	no.	1	To create the door handle of the tent, and other minor things (i.e. reinforcing the roof)

Nylon wire (1mm)	no.	1	There are 4 in the construction kit, however 1 full roll is used to saw tarpaulin for the tent roof
Nails/ screws 5cm	kg	2	For the windows
Nails/ screws 10cm	kg	2	For the roof and structure
Construction Kits			
Measuring tape (20m)	no.	4	Long measures
Plumb line	no.	4	To place the poles structures straight
Level	no.	4	To place the poles structures horizontal
3mm plastic rope (100m roll)	no.	4	
Pliers	no.	4	
Cutter	no.	4	
Axe hammer	no.	4	
Iron lifting	no.	4	
Wood saw (with handle)	no.	4	
Metal meter (5m)	no.	4	Small measures
Training			
Travel plus DSA for central		1	Calculate travel days plus 2 days per each community where 1 tent will be constructed (4 days for 1 tent)
Per diem for 2 community members (trainers)		2	Calculate 2 days x each tent
Food for 4 trainers+ 1 driver + a local construction team of 8		13	Calculate for 2 days Involve women for sowing the roof (2 women will take 1 day), hammering nails, preparing nails with bottle caps

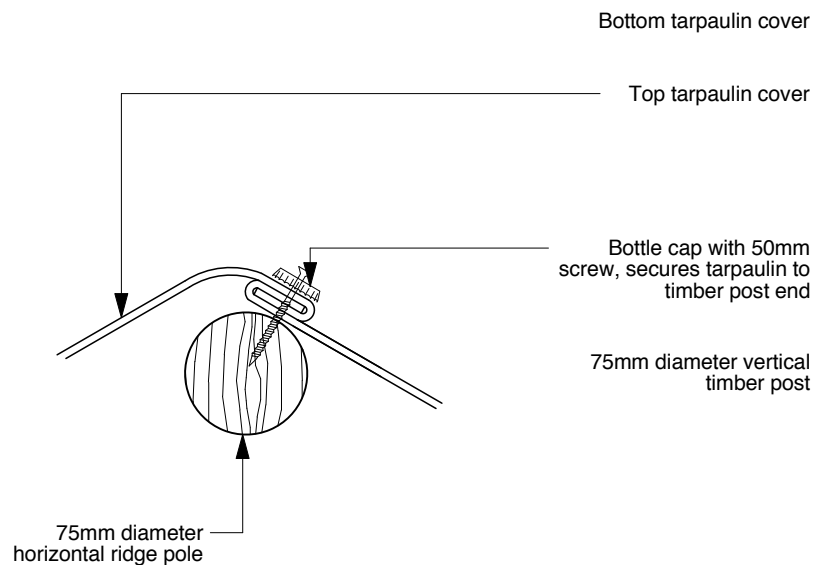


Scale 1:50

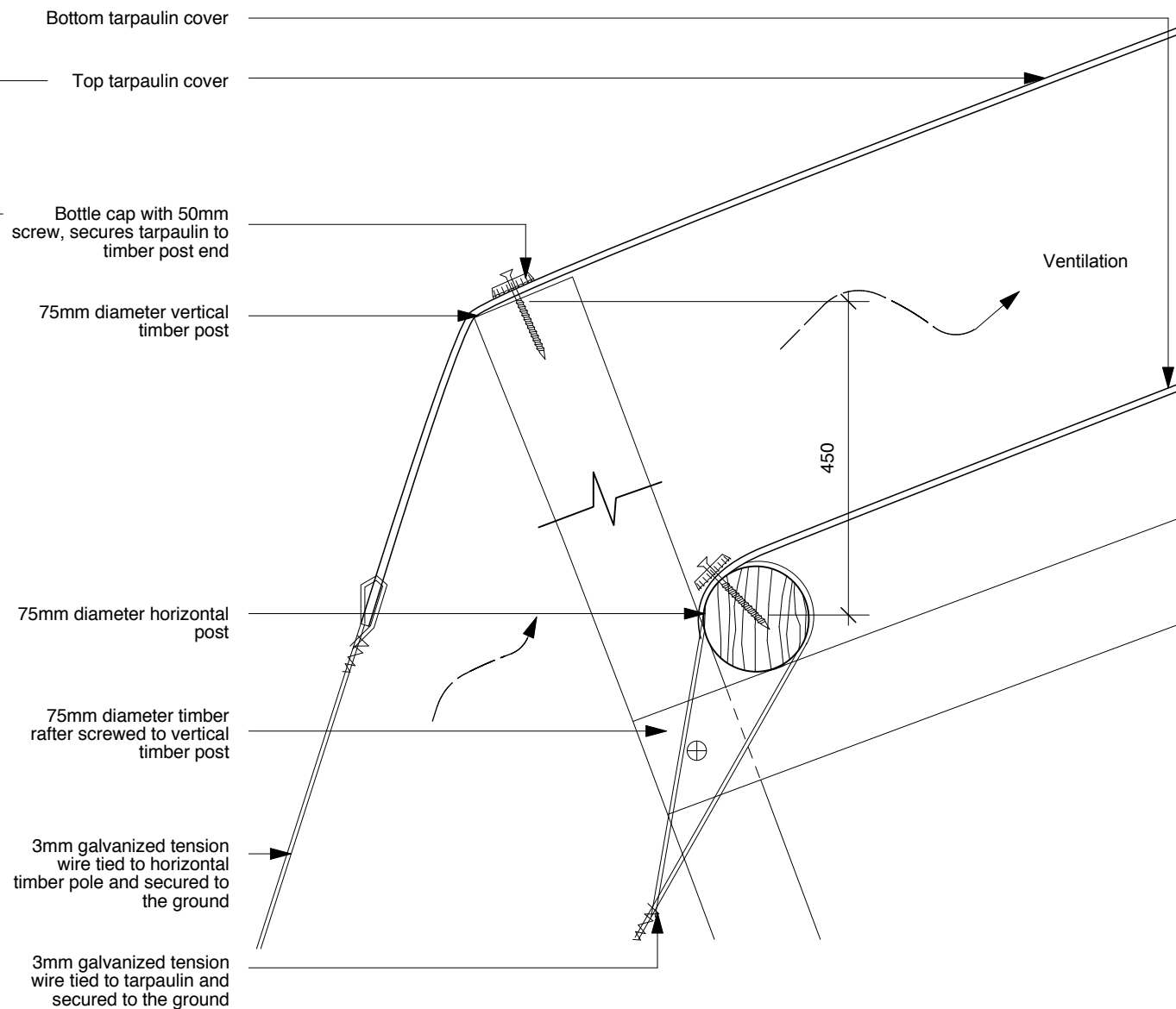


Scale 1:50

Detail 1



Detail 2



Scale 1:5



Photo: UNICEF, Sri Lanka

External view

SRI LANKA

2006-Onwards / IDP Camp / UNICEF

Agency:	UNICEF in collaboration with Sri Lanka Government School Works Unit
Location:	Northern and Eastern provinces, IDP camp of Manik Farm in Vavuniya, Jaffna and Trincomalee district
No. of users:	Approx. 28-35 children per classroom
Anticipated lifespan:	One year (for prefabricated GI pole construction/ thatched roof)
Actual lifespan:	-
Facilities provided:	5 classrooms per block, outdoor activity/playspace, WASH facilities through the WASH sector initiatives

No. of facilities:	7 blocks of 35 TLSs in the Batticaloa, 38 TLSs in Mullaitivu, Kilinochchi and surrounding villages (this is not a complete number)
Construction time:	3 months for 35 TLSs in the Batticaloa
Main construction materials:	Timber poles or prefabricated GI hollow steel section structure, corrugated galvanised 0.45 mm thick iron sheets, cadjan roof thatching, cement for flooring
Material sources:	Locally sourced
Approx. project cost per unit:	-
Approx. material cost per unit:	-
Size of units:	Classroom: 29.5sqm; block: 150sqm
Size of construction team:	-
Construction skill required:	Basic construction skills, carpentry works
Who built the facilities:	Implementing NGO, contractors, School Development Societies
Site information:	Sites had various conditions with risk of flooding, limited accessibility in IDP camps, land scarcity particularly after tsunami

Background

Still recovering from the massive destruction caused by the Indian Ocean Tsunami of December 2004, Sri Lankans faced fresh challenges in 2006 brought about by a resurgence of civil conflict. Three million people were affected and half a million forced to abandon homes, schools and medical facilities. The end of the 30-year war in Northern and Eastern provinces in May 2009 resulted in a total of about 300,000 IDPs living in the large IDP camp of Manik Farm in Vavuniya. Other IDP camps in Jaffna and Trincomalee district were set up in 2009 by the government to accommodate additional IDPs.

Manik Farm was originally barren land belonging to the government. From the camp's inception the Sri Lankan Army managed the camp but IDPs remained in the camp. Shelters were made with tarpaulin sheets, cadjans (coconut leaves) and tin sheets. One shelter often accommodated more than one family. The movement of all IDPs within Manik Farm was closely monitored by the Sri Lankan Army. Access to the camp for service providers was also monitored closely.

Project Description

The prolonged conflict and limited development activities in the northern and eastern parts of Sri Lanka resulted in the long-term functioning of schools in TLSs. The TLSs were part of UNICEF's education in emergency response providing access to education for affected children. TLSs have provided classroom facilities for children to continue with their learning when the schools were damaged or communities displaced by man-made and/or natural disasters. Some children have spent their entire school life only in TLSs for more than ten years.

TLSs were identified by the government education authorities, UN agencies and NGOs as a means to meet the urgent need for learning spaces. In Sri Lanka there has been no government financial allocation to put up TLSs even in emergency situations. Therefore, donor funds were utilised throughout the conflict situation. The setting up of TLSs was very fast and cost effective and provided access to education for vulnerable children.

Depending on the situation and location of the TLS, different types of structures were put up by implementing partners. Longer lasting TLSs (with a one year lifespan) were renovated periodically by re-thatching roofs over time.

The Government School Works Unit attached to government education departments at the zonal level prepared TLS designs and estimates. During construction, the technical officers attached to these offices supervised and monitored the work done by contractors. Contractor selection was done as per the Sri Lankan governmental standard system. The construction works and the quality of works were monitored through site visits by the implementing agencies.

WASH facilities including drinking water points and latrines and external play/recreation spaces were included. School-in-a-box kits, blackboards, uniforms, schoolbags and stationery are distributed in order to accelerate the integration of conflict-affected children into learning environments.

TLS Summary

In general, one block of TLS was 30.5m long and 4.9m wide (100x16 feet) accommodating five classes. Each individual class space was 29.5sqm and 6m long x 4.9m wide (20x16 feet). The blocks were either arranged in a U shape to form a courtyard arrangement or alternatively in a linear arrangement, where the spaces in between blocks were used as 'spill-over' classrooms.

There were four variations of the same basic Transitional Learning Space structures adopted during different periods:

Firstly, a very basic timber pole structure with tarpaulin sheet roofing without side covers or sealed flooring. Secondly, a timber pole structure, timber roof structure and cadjan thatched roof cover were constructed. Floors were made with compacted earth and covered with tarpaulin sheets.

Later on, this structure was modified with prefabricated GI pipes which allowed for the reusing of TLSs in new locations, such as student returnees' home villages. It had a cadjan thatched roof or GCI sheeting cover, 900mm high side covering and class dividers made from tarpaulin, corrugated iron sheets or cadjan according to local availability. This design had sealed raised cemented flooring. The cement flooring was mainly used after the 2004 tsunami.

Different construction process modalities were used depending on the individual situation: a) direct payment to contractors upon request of government partners; b) fund transfer to government partners who contracted TLS construction; c) Small Scale Funding Agreements with School Development Societies (SDS) who subcontracted construction. This method provided benefits directly to school communities. Lastly, implementing NGOs constructed TLSs directly by using their own employees.

Maintenance

At least once per year the cadjan roofs needed to be re-thatched. There was no government allocation to maintain TLSs. Donors were sought frequently by education authorities to get funds for maintenance of TLSs. In the IDP camp Manik Farm, additional funds were provided to buy basic tools such as mammoties, shovels and motor-pans for draining rainwater from TLSs.

DRR

The main aspect to be considered is the location on higher ground if possible to protect the structure from repeated flooding.

Challenges

- The demand for TLSs was very high in Manik Farm due to the huge number of IDP children. The restricted movement environment of Manik Farm made mobilising labour/materials extremely difficult.
- Land scarcity, particularly after the tsunami. The education authorities and school principals had to get consensus from landowners prior to construction.
- The situation in Manik Farm was unique as the selection of land rested with Camp Management (military). This system limited the selection of the best pieces of land for construction.
- The monsoon rains and accompanying floods damaged TLSs and temporarily disrupted education. IDPs remove parts of the TLSs to improve their own shelters while other IDPs occupied TLSs since they were built better than their living shelters. Remarkably, IDPs returned borrowed pieces of TLS each morning during the monsoon before the commencement of school in order for their children to be able to study in a safe place.
- Initially, the TLSs were constructed by the ZDE (Zonal Director of Education) only. Instead of constructing them through a competitive bidding process, the Government asked ZDEs to build TLSs through SDSs (School Development Societies) at estimated prices. This led to poor accountability and monitoring of work executed on the ground.

Lessons Learned

- Different designs are suitable for varied locations and conditions. There is no one prototype of a TLS that suits all circumstances. The basic structure should allow some form of adaptability to respond to the different conditions, hazards, wind directions
- The site selection is crucial. It is important to choose places on elevated land or raise the floor plate to minimise flooding and disruption of education. In these cases the access to the raised areas need to be taken into consideration
- Ownership of TLSs should be properly handed over to beneficiaries immediately after construction is completed to avoid the perception that the structures are the property of different implementing agencies
- Competitive tender process (such as obtaining three quotations) allows for better control and construction quality

Improvements

- Adequate foundations with above ground connection to timber poles to prevent deterioration of timber poles
- Strengthening timber pole uprights to roof trusses connected by metal plates, binding wire or well-crafted interlocking timber joints
- Consideration to alternative access for emergency escape and circulation
- Consideration to raising the floor level to protect from flooding
- Additional timber substructure to wall cladding required
- Raised gable ends with CGI sheeting to help enclose the classrooms, increasing shade and acoustic isolation



School children playing on external play space of upgraded TLS in Haiti

Photo: UNICEF Haiti



Photo: UNICEF, Sri Lanka

External view of timber post structure TLS in Kodikamam area, Jaffina



Photo: UNICEF, Sri Lanka

External view of prefabricated steel posts TLS



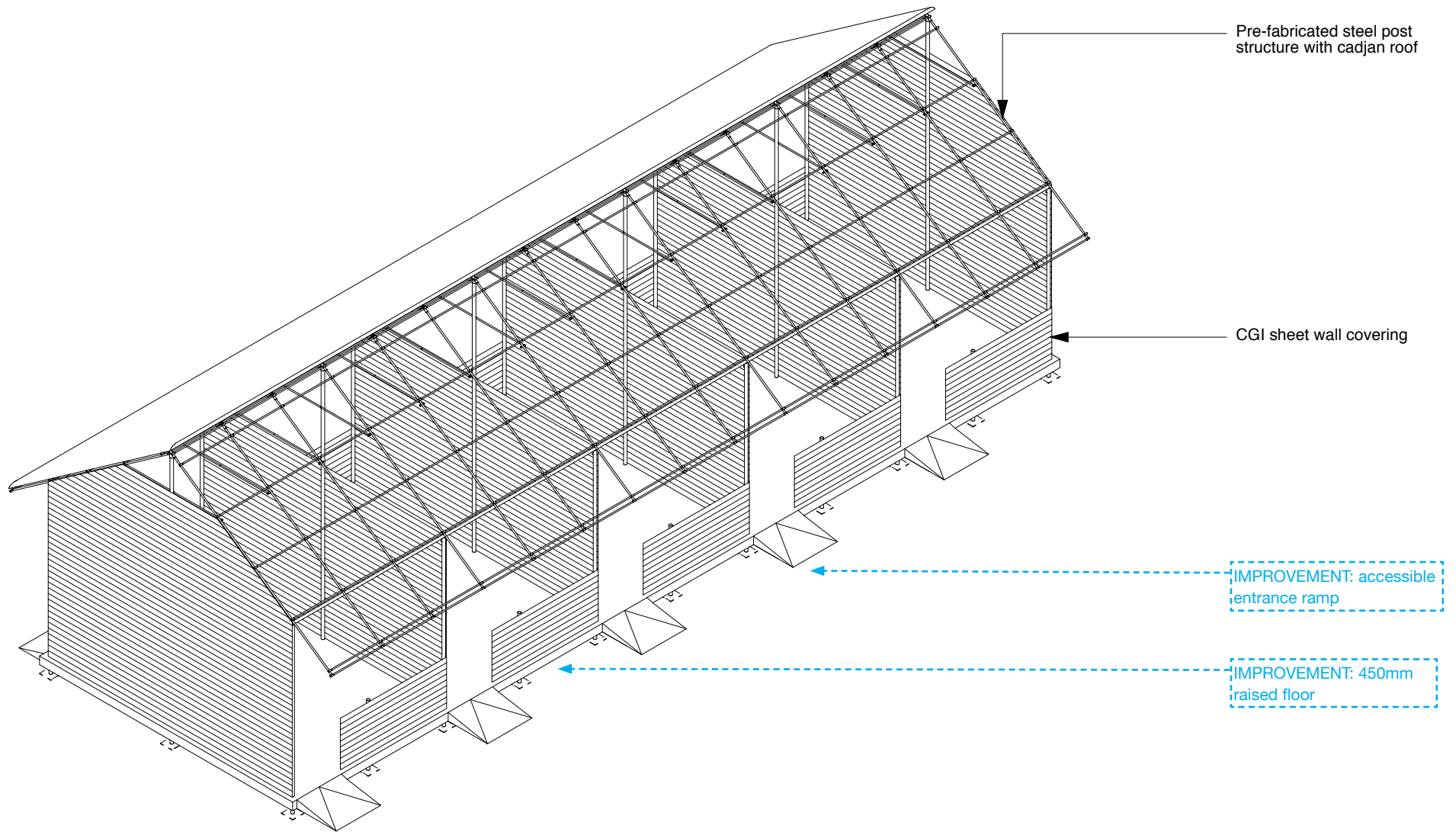
Photo: UNICEF, Sri Lanka

Internal view of prefabricated TLSs in Batticaloa

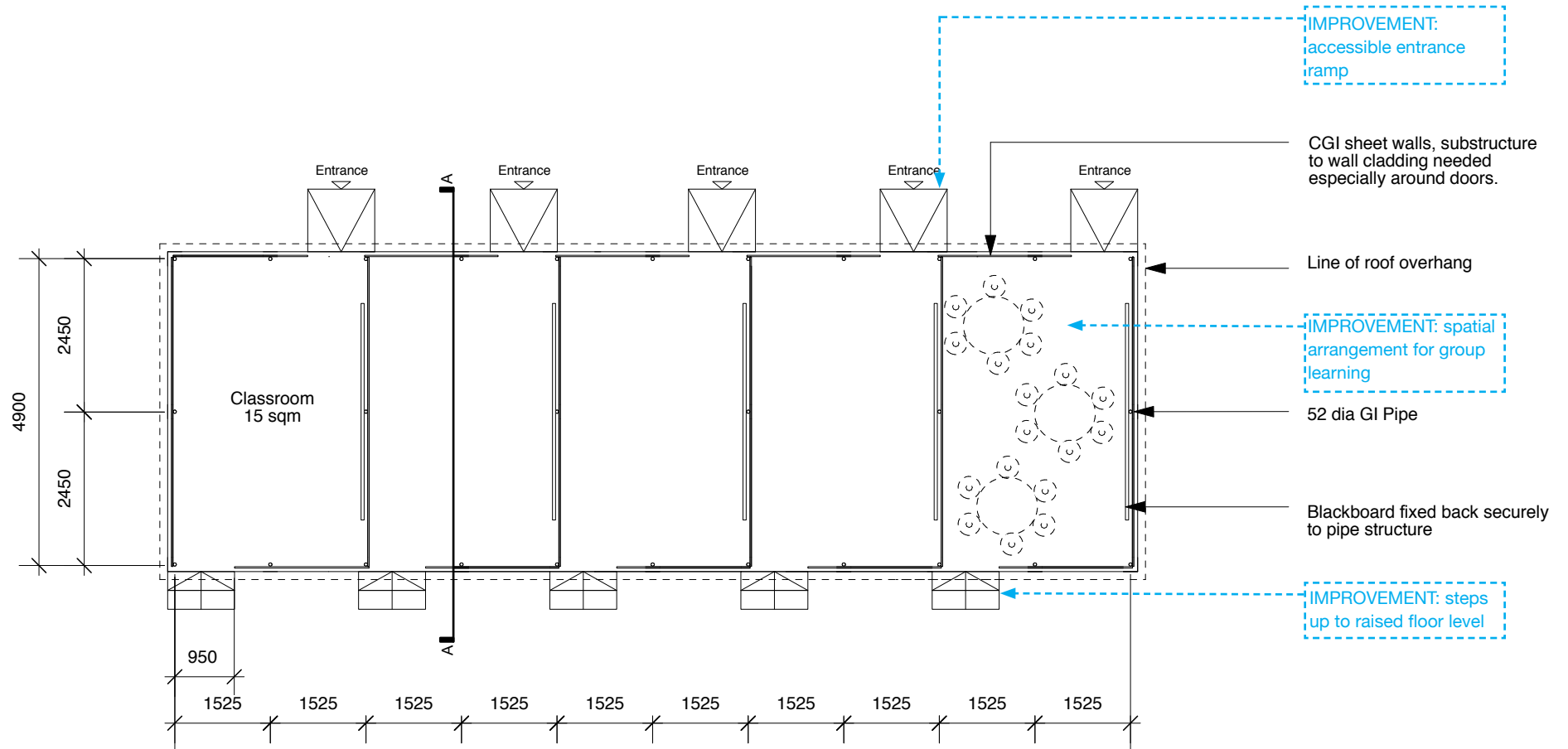


Photo: UNICEF, Sri Lanka

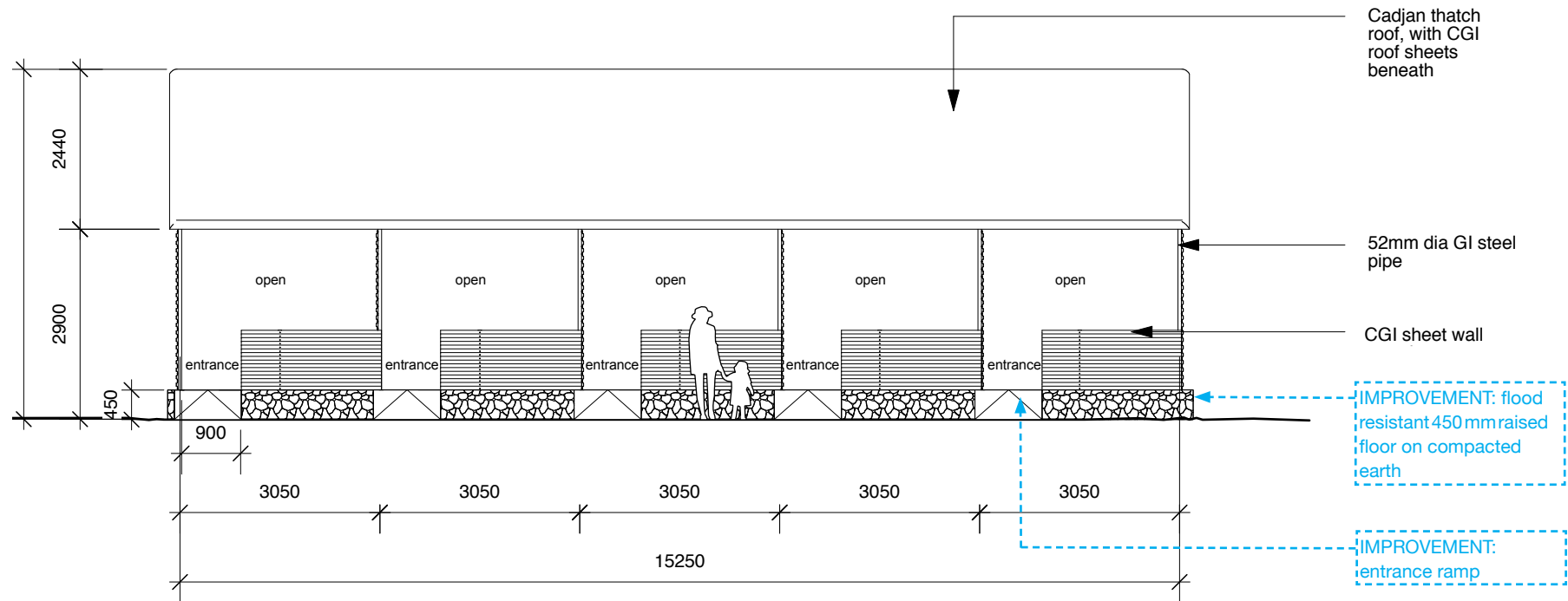
Internal view of timber post TLS in Jaffina



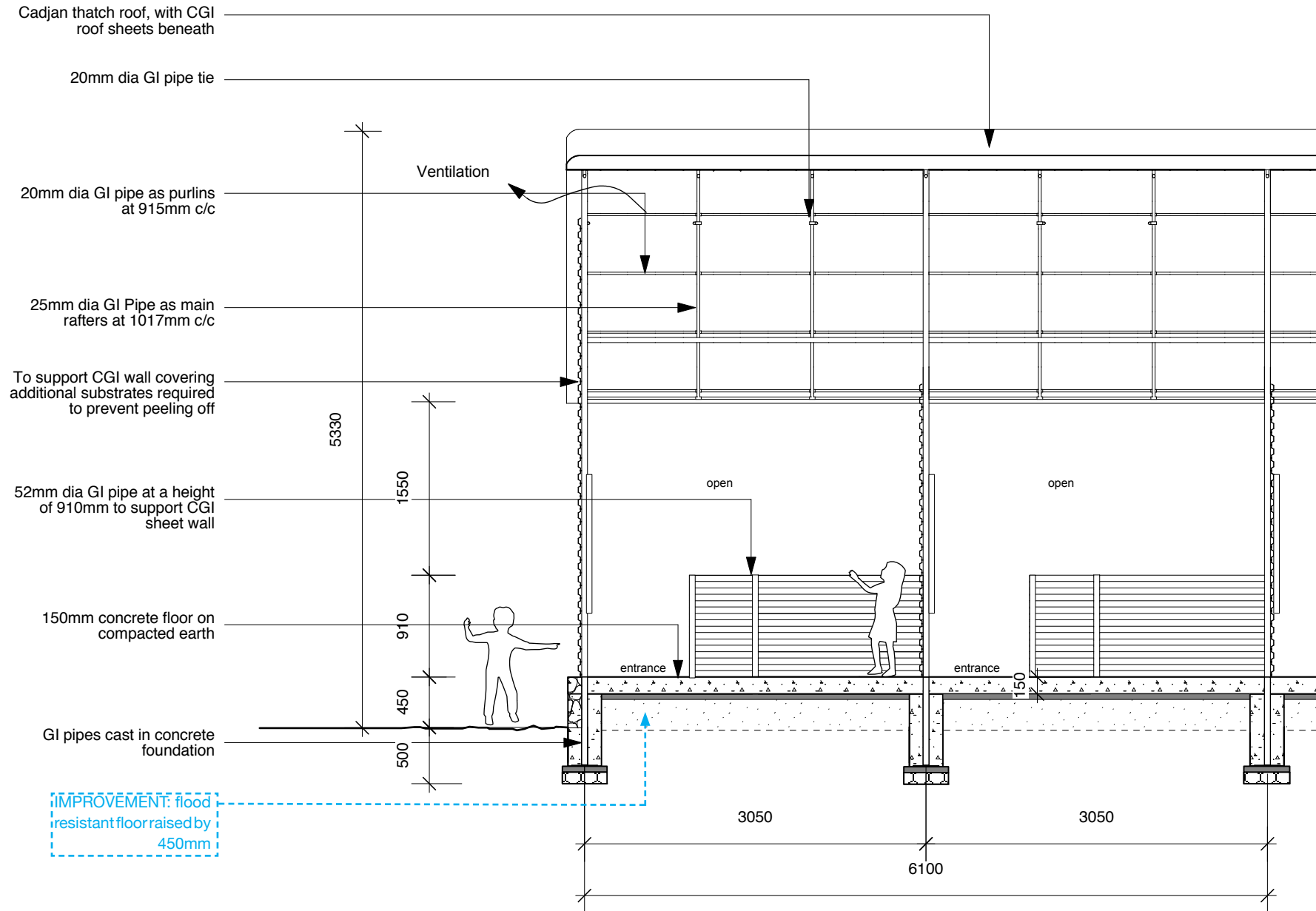
Note: drawing not to scale, for illustrative purpose only



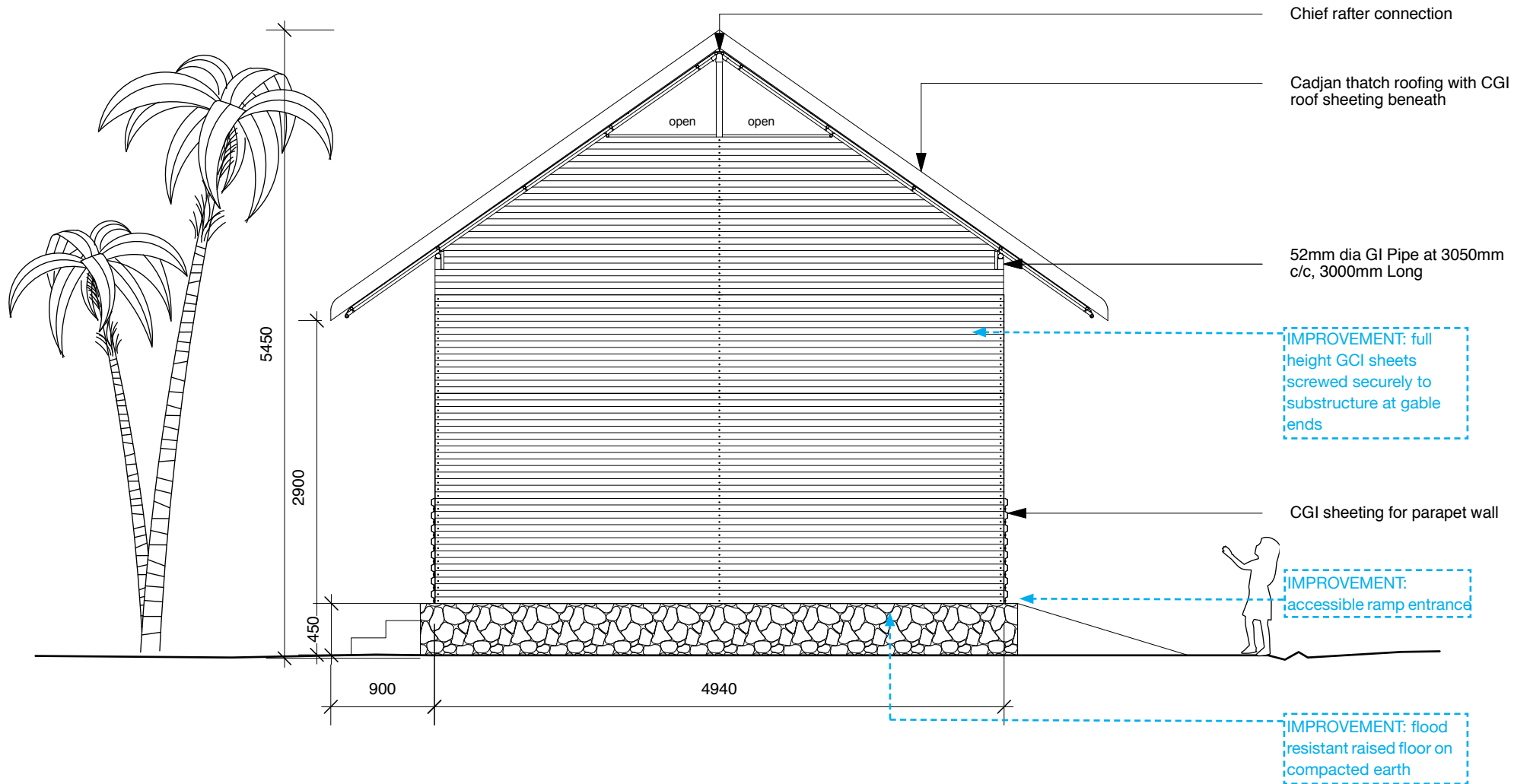
Scale 1:100



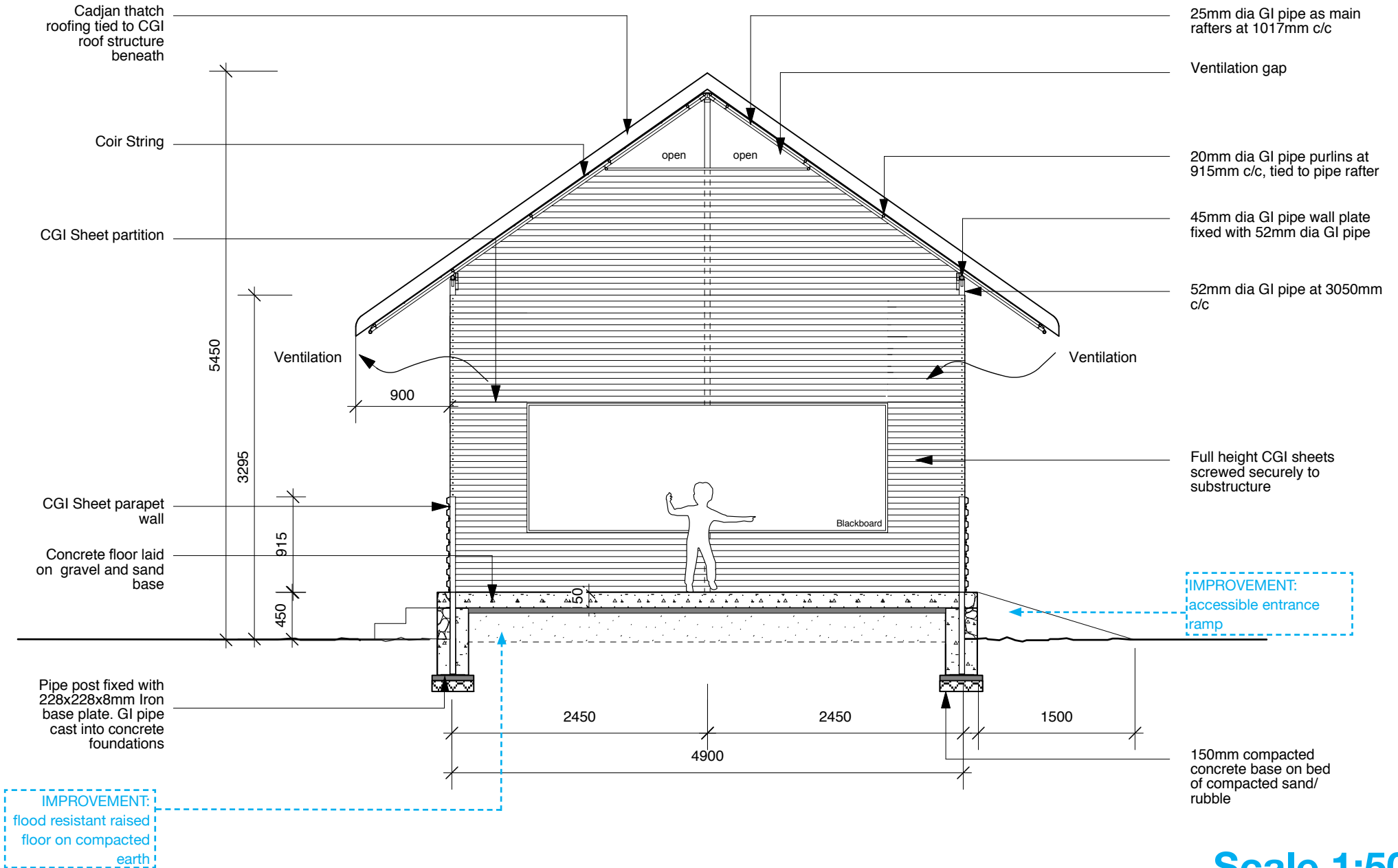
Scale 1:100



Scale 1:50



Scale 1:50



Scale 1:50

Quantities for five unit block, 75sqm

Elements	Unit	Quantity
Foundations		
Concrete	m ³	12
Walls		
CGI sheeting	m ²	100
GI pipes (52 dia x700mm)	no.	10
GI pipes (52 dia x1100mm)	no.	10
GI pipe posts (52 dia x 3900mm) at 3050mm c/c with welded iron base plates 12 x (225x225x6mm) buried 800mm underground	no.	12
GI pipe posts (52 dia x5500mm) at 6100mm c/c with welded iron base plates 12 x (225x225x6mm) with sockets needed to fix with ridge buried 800mm underground	no.	6
GI pipe wall plate (45 dia x3050mm) fixed with pipe post, sockets required for junctions	no.	10
Roof		
GI pipe rafters (25 dia x3900mm) at 1000mm c/c	no.	32
GI pipe purlins (20 dia x3050mm) at 900mm c/c tied with rafters, sockets required for junctions	no.	70
GI pipe tie beams (20 dia x1925mm)	no.	16
Bolts & nuts	no.	600
Sockets (between rafter and purlin)	no.	224
Sockets (ridge)	no	6
Cadjan thatch	m ²	123

Field Notes:

This is space for individual field notes, documentations and observations.



Photo: Karel Stork

External view of upgraded structure with bamboo matts, thatched roof and sealed screed flooring

MADAGASCAR

2007 / Cyclone / UNICEF/ Aluronda

Agency:	UNICEF
Location:	Northern region of Sofia, Diana, Sava, Analanjirifo, Vatovavy, Fitovinany
No. of users:	0-45 pupils per classroom, 9000 students total and 200 teachers
Anticipated lifespan:	25 years for tarpaulin Stabilised mud block walls: regular maintenance last a long time Roof thatching: with regular maintenance approximately 20 years
Actual lifespan:	e.g.: Afghanistan's tent version in good condition after 5 years
Facilities provided:	Classrooms, latrines

No. of facilities:	90 Aluronda TLSs on 54 sites in the five regions
Construction time:	Aluronda (tent) 4 hours Stabilised mud blocks/thatch version: (roofing, floor, walls)10 to 14 days (excluding material sourcing/delivery)
Main construction materials:	load bearing heavy duty aluminium structure, polyester/PVC tarpaulin, thatch, brick/palm tree matts, screed
Material sources:	Imported Aluronda structure, wall, roof and floor material locally sourced
Approx. project cost per unit:	Madagascar 8000 USD (2009 price), Zambia 9000 USD (2011 price), Senegal 7000 USD (2011 price)
Approx. material cost per unit:	Aluronda aluminium structure only: 3600 USD (50sqm)
Size of units:	Floor area 50sqm, flexible size as modular
Size of construction team:	5 or 6 people for aluminium structure plus 1 foreman
Construction skill required:	Tent: no construction skill needed, knowledge/understanding of technical drawings Stabilized mud blocks / thatch version: skills in masonry work, thatching/carpeting/concrete/masonry works required
Who built the facilities:	Technical skilled site foreman supervising local community members (e.g.: Zambia built by local women)
Site information:	In rural community provided the sites, recommended orientation: axis in direction of dominant wind, levelling of uneven ground, must be possible to drill/ dig holes 60cm deep

Background

In 2005 the construction of Aluronda classrooms on Madagascar was done to explore possibilities for the use of alternative technology for building in cyclone-prone rural districts.

Cyclone Indlala struck the north-eastern coast of Madagascar on 15 March 2007, arriving with winds of more than 230km/h unleashing torrential rains and the subsequent flooding left thousands homeless and destroyed livelihoods, homes and school buildings. Over most of the region, locations were affected by flash floods, which had the most damaging impact. The damage reported due to the wind was minor. There was a strong impact on wells and water sources where stagnant water took time to drain, presenting a high risk in terms of public health.

Project Description

The Aluronda Convertible kit was implemented for the construction of transitional learning spaces in isolated rural communities in the north regions (Sofia, Diana, Sava, Analanjirifo and VatovavyFitoviny) of Madagascar affected by cyclone Indlala. 90 anti-cyclone Aluronda structures were delivered by truck to 23 sites in the northern region.

The construction was carried out in close collaboration with local education authorities (CISCOs) and the local communities were mobilised. Mobile technical teams were engaged to assist in the erection of the structures and the supervision of communities in constructing the walls and roofs with locally available materials. Apart from the imported Aluronda aluminium structures all construction materials for the walls and roof (cement, stones, gravel, sand, bricks) were locally procured. The implementation started in July and was completed by the end of August, in time for the start of the 2007/2008 school year. The Aluronda structure can be erected by five or six people including one skilled foreman within one day.

The affected schools were also provided latrines in the region of Antsohihy in collaboration with the regional direction of national education (DREN) and those affected by the flooding were rehabilitated and disinfected for drinking water supply.

TLS Summary

The design concept of the Aluronda kit is a very versatile, easily erectable aluminum skeleton structure, which itself has a high degree of wind resistance. It consists of a heavy duty aluminum structure and heavy duty polyester/PVC tarpaulin which is strong, long lasting (at least 25 years), fireproof, sun, heat and UV resistant, light and cool. It is suitable for hot and humid tropical/sub-tropical climates and has been implemented in many countries as TLS (Burundi, Afghanistan, Senegal). The structure can be used repeatedly in emergencies, re-locations and transportation to hard to access areas. The aluminum skeleton structure is the basis for walls and roofs of available local materials, which either can be blown away during cyclones and easily renewed or are constructed to resist the wind loads together with the structure.

The aluminium structure is 50sqm (10m long x 5m wide) and 4.5m high to the ridge and 2m to the eaves. The total length of the structure is flexible and can adapt to different space requirements. The structure is cyclone resistant through tied anchoring to the ground. A plastic coated steel wire of five mm is pulled through the aluminium tube rafters and fixed to special steel plugs into the ground. The wire is stretched by stainless turnbuckles for a proper anchorage of the structure to the ground. The roof is initially covered with tarpaulin. The roof and wall can be upgraded by local materials, such as palm mats and lightweight thatch roof or with non-load bearing brickwork walls and thatch roof.

Both options provide good ventilation through a 150mm ventilation gap between wall and roof structure. The foundation is made of plastered brick and floor is made of concrete screed or compacted earth.

For more information on the Aluronda convertible kit, construction manuals, tool required please contact the designer: Karel Stork, architect MNAL, Stork Project AS, Norway, e-mail: post@storkproject.com

DRR

The main aspect to be considered is the location on higher ground if possible to protect the structure from repeated flooding.

Maintenance

- The aluminium structure requires checking and re-tightening of connection to ground, checking that the aluminium structure remains securely imbedded in the ground (minimum 600mm)
- Stabilised mud blocks/thatch version: regular maintenance by skilled craftsmen for thatching and regular maintenance of external walls for water damage, especially to lower wall area. Lime-based render to external walls is advisable to protect from deterioration.
- UNICEF supported the training in emergency preparedness of the school communities.

Challenges

- The Aluronda tent structure requires shipping and storing in safe storage facilities
- Transportation of crates to site is required

Improvements

- Guide wires to be made visible by flags or equivalent, pegs in ground to be protected by sandbags (to avoid injury of children playing around structures)
- A lower cost window solution has been developed
- Consideration to accessibility should be given in form of ramp into classrooms and width of doors, level and sealed flooring, and classroom furniture arrangements



Photo: Karel Stork

Aluronda imported tent



Photo: Karel Stork

Aluronda tent assembly process



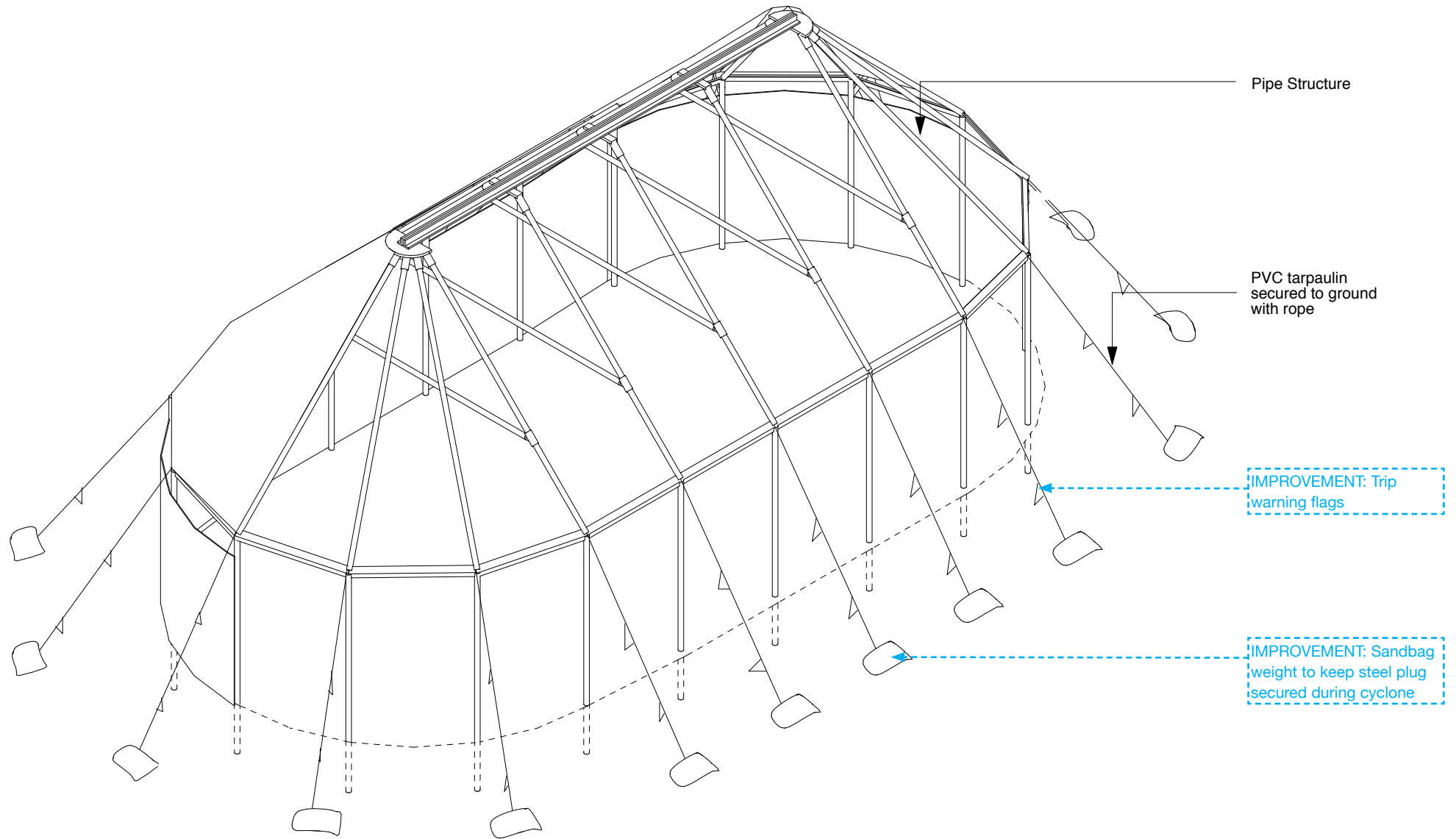
Photo: Karel Stork

Updating with external brick wall around the tent structure

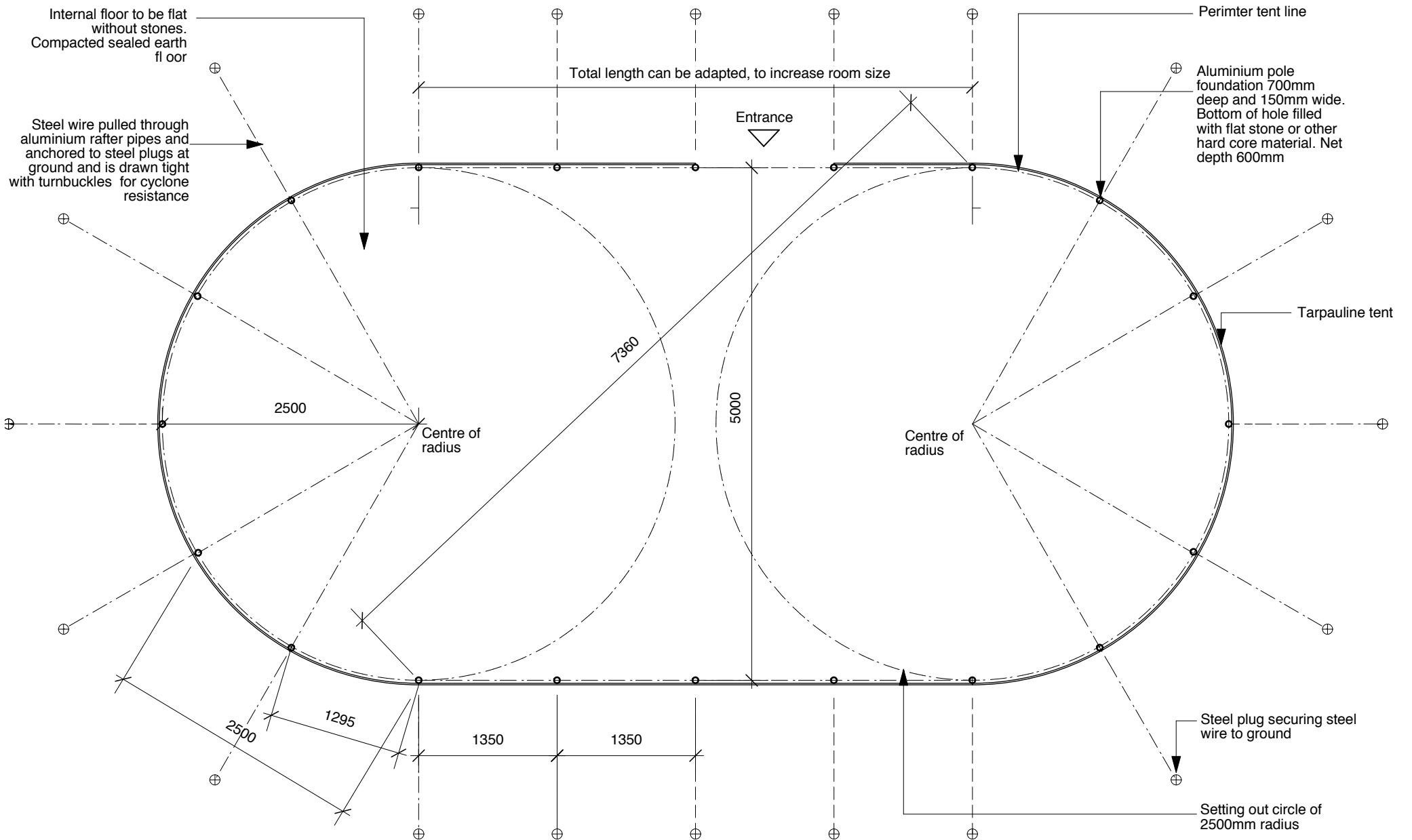


Photo: Karel Stork

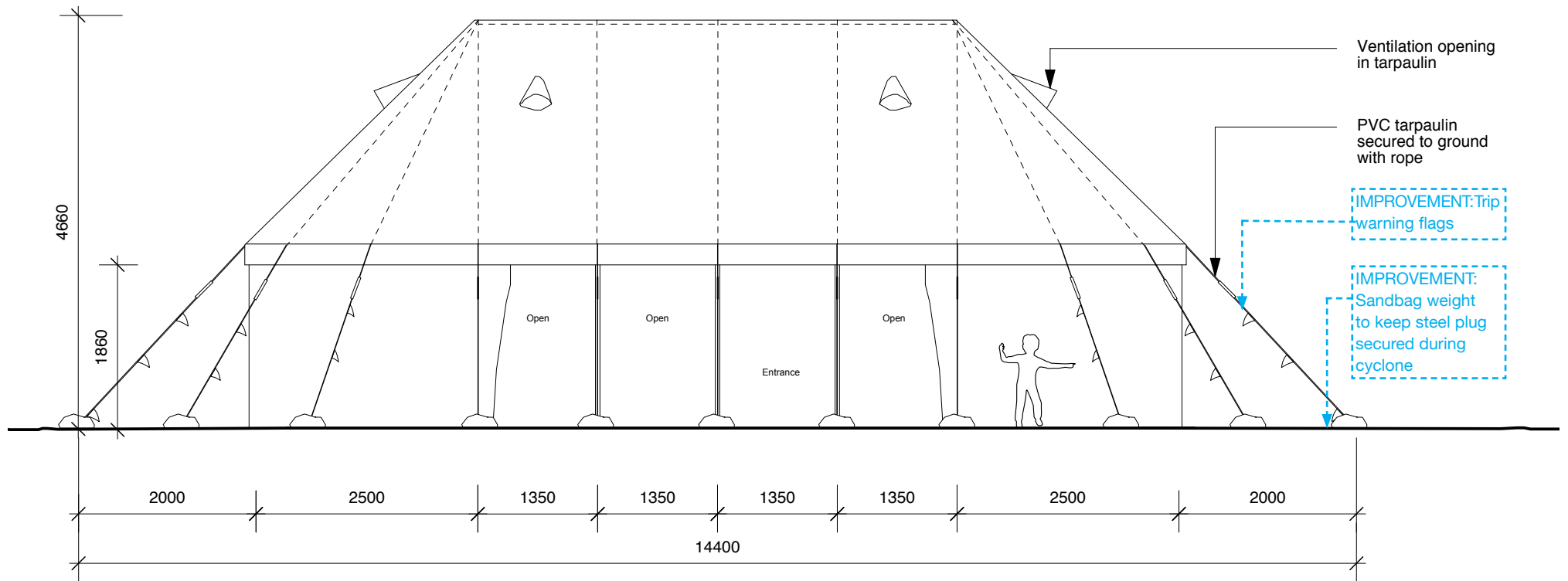
Internal view of Aluronda tent



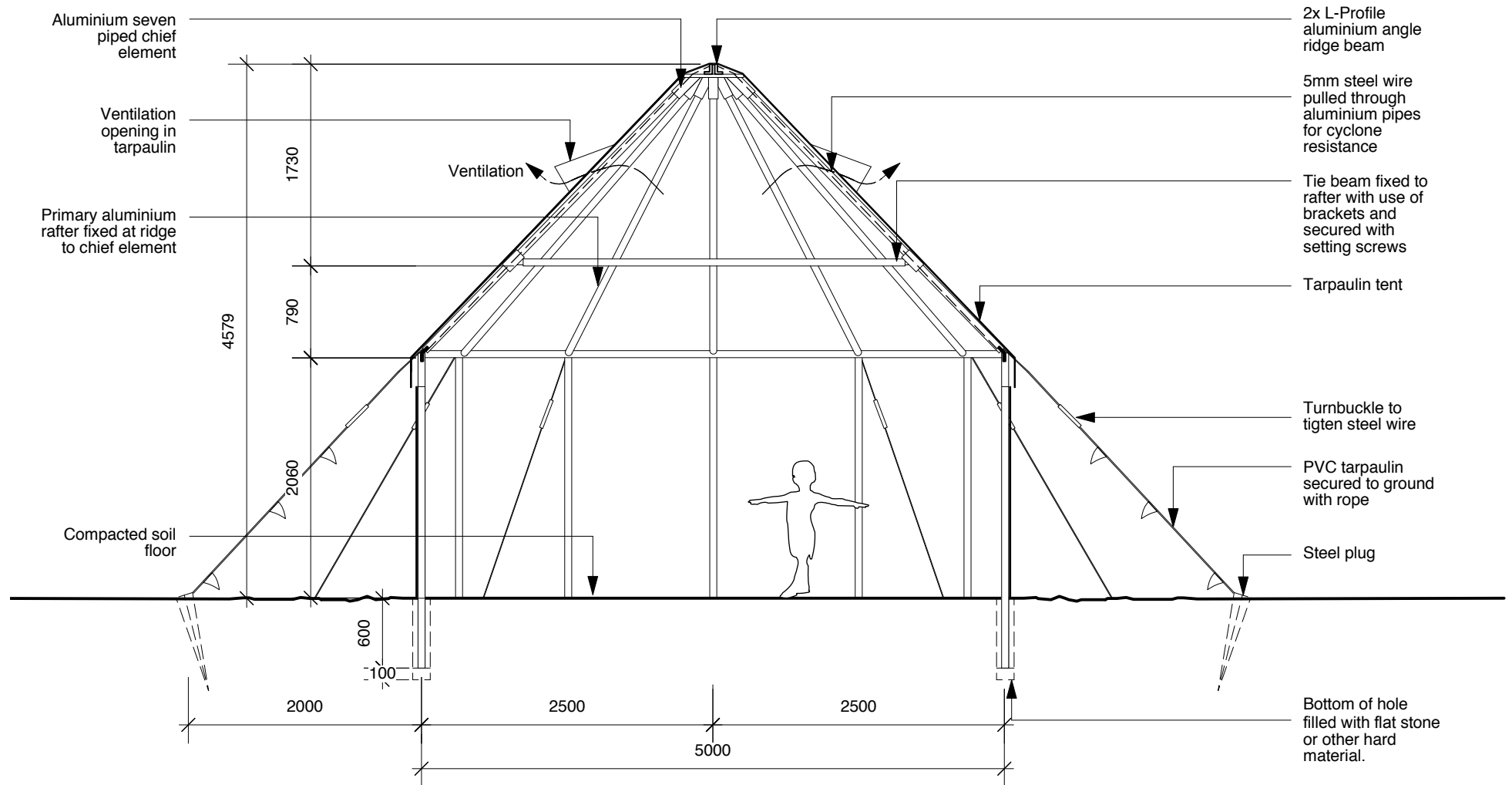
Note: drawing not to scale, for illustrative purpose only



Scale 1:50



Note: drawing not to scale

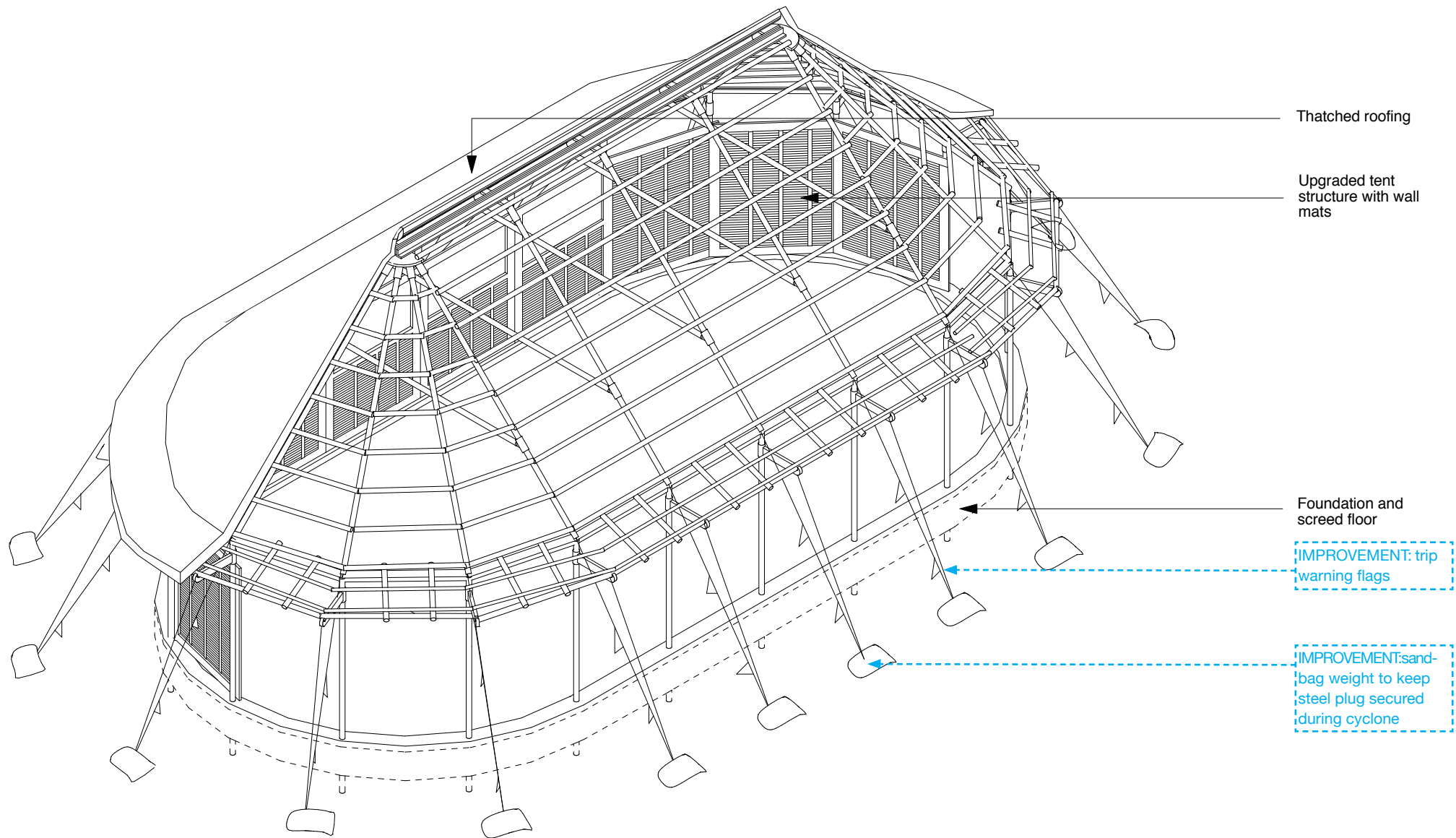


Scale 1:50

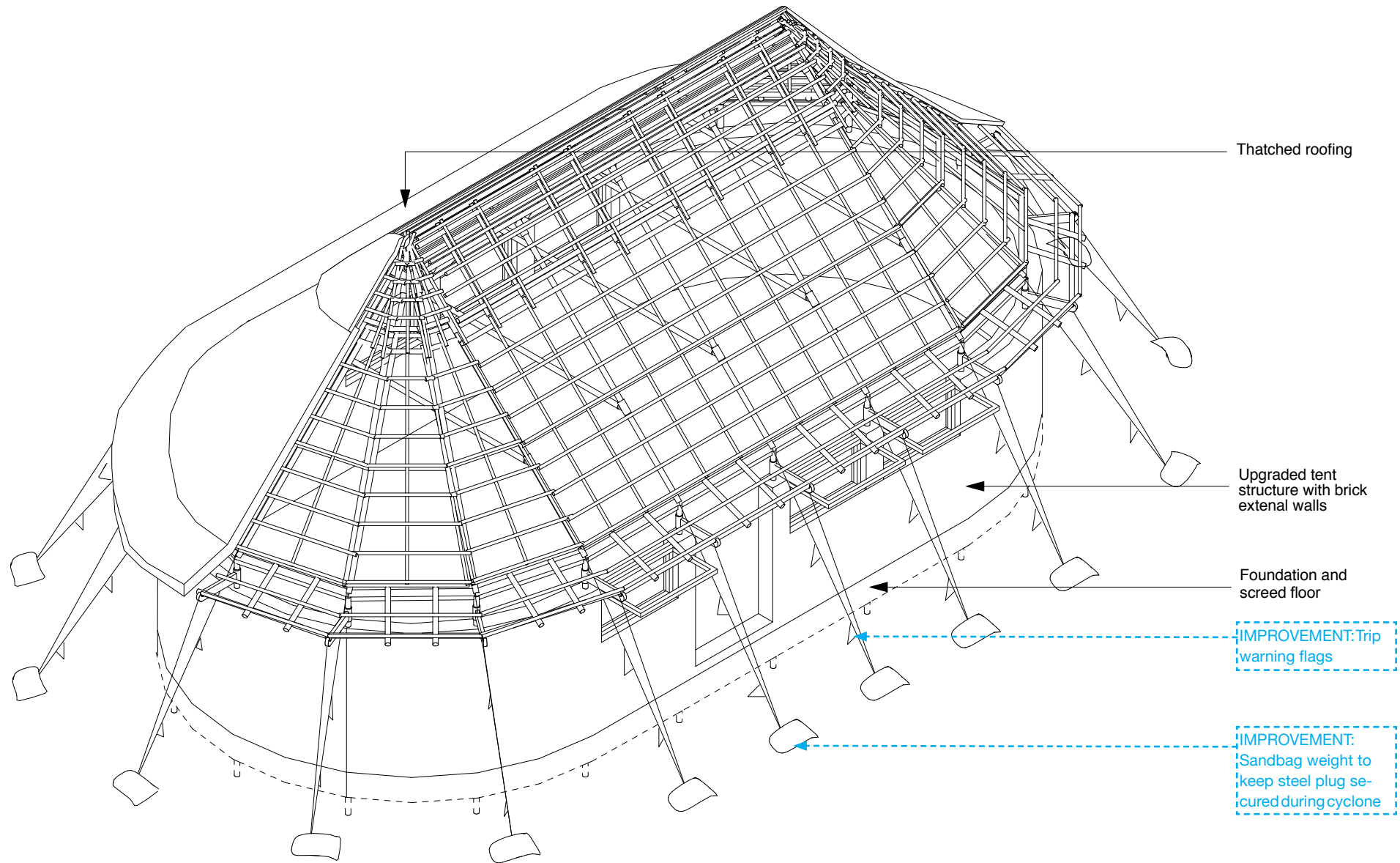
Quantities for one upgraded unit of 50sqm

Elements	Unit	Quantity
Foundations		
Foundation ring To be noticed: external wall is not load bearing, therefore the foundation is proposed to be done of max. 5 courses of burnt bricks or 2- 3 courses of concrete blocks	m	27
Bricks (Foundation ring)	no.	1100
Cement for mortar	bag	6
Sand for mortar	m ³	0.06
Floor bedding The floor to be laid on 10cm compacted hardcore finishes with a layer of sand or similar and 500 gr/m ²	m ³	5
Polyethylene DPM	m ²	50
Floor 10cm thick concrete slab with A98 mesh finished with steel float	m ³	5
Cement for concrete slab	bags	33
Mesh A98 4x (5mx 2m)	m ³	40
Sand/ gravel	m ³	5
Walls		
Soil blocks stabilized with cement	no.	2000
Local soil (digging, transportation, sift) for production of 2000 blocks (12x12x20cm approx. 16 courses)		
Soil for 2000 blocks	m ³	5
Cement 6% for 2000 blocks	kg	150

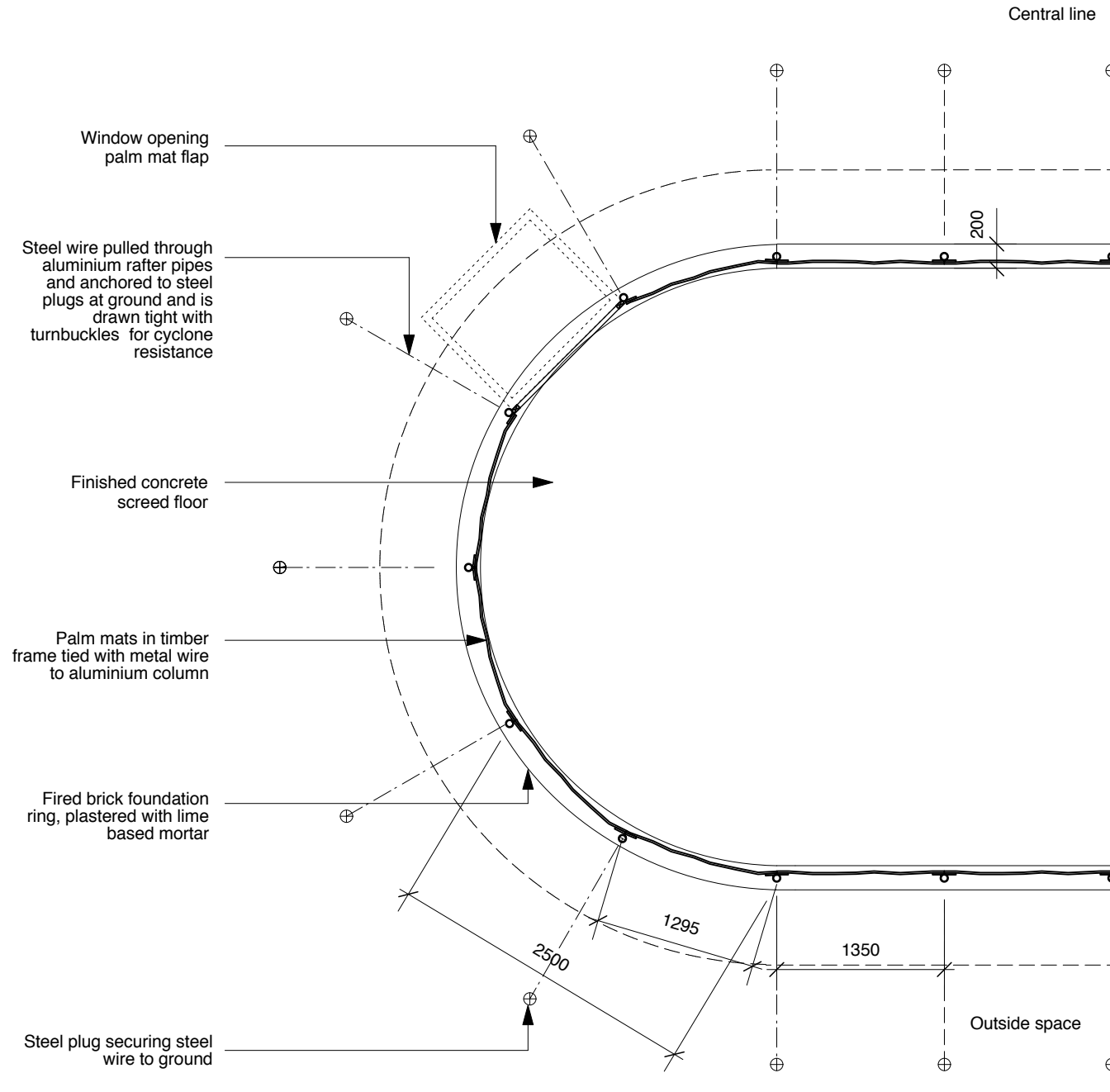
Sand for mortar	m ³	5
Cement for mortar	bags	30
Roof		
Balls of grass for thatching		
Bamboo sticks	Bundles	1200
String for fixing the thatch	m	50
	m ³	54
Entrance door Frame ledged and braced, accommodated to wheel chairs, complete with door locks, handles and hinges, vanish, wire nails	no.	1
Palm mat windows frame, clear glass, window putty, window handle, peg stays, mortice locks Window area at least 5sqm	no.	6-10
Wall surface External wall to be painted with lime based paint directly on blocks in 2- 3 layers. Both sides of wall 103sqm 1 kg lime to 4 litres water/ to 4sqm wall	bag	3
Aluronda Structure Construction kit complete with tools, accessories, mounting directions	no.	1
Labour		



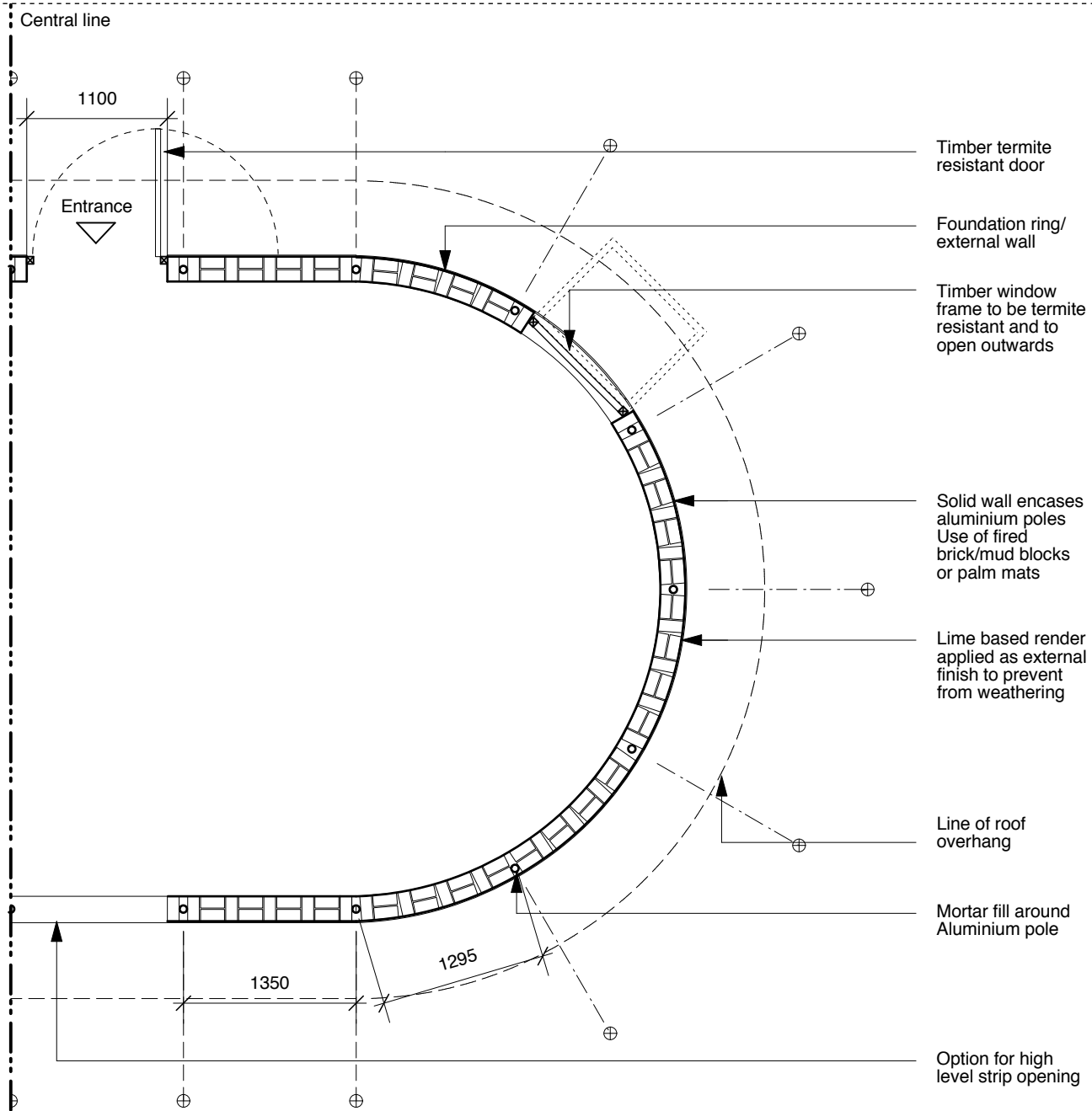
Note: drawing not to scale, for illustrative purpose only



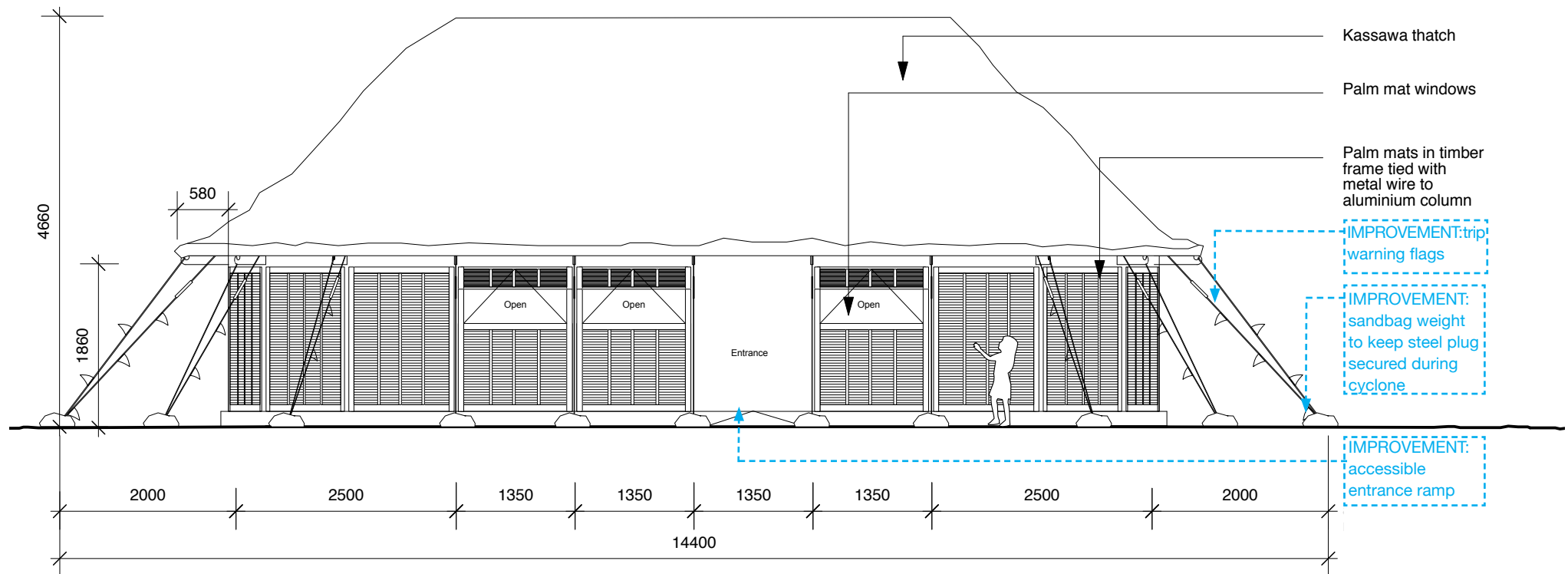
Note: drawing not to scale, for illustrative purpose only



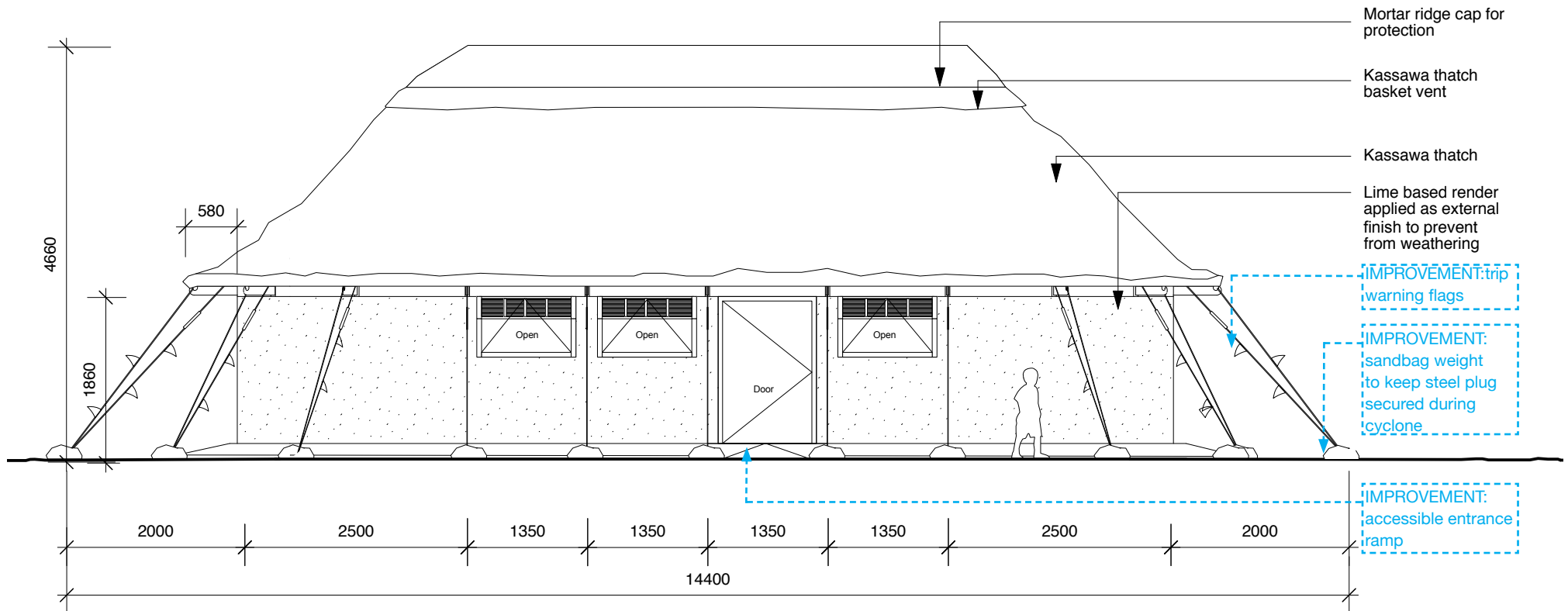
Scale 1:50



Scale 1:50

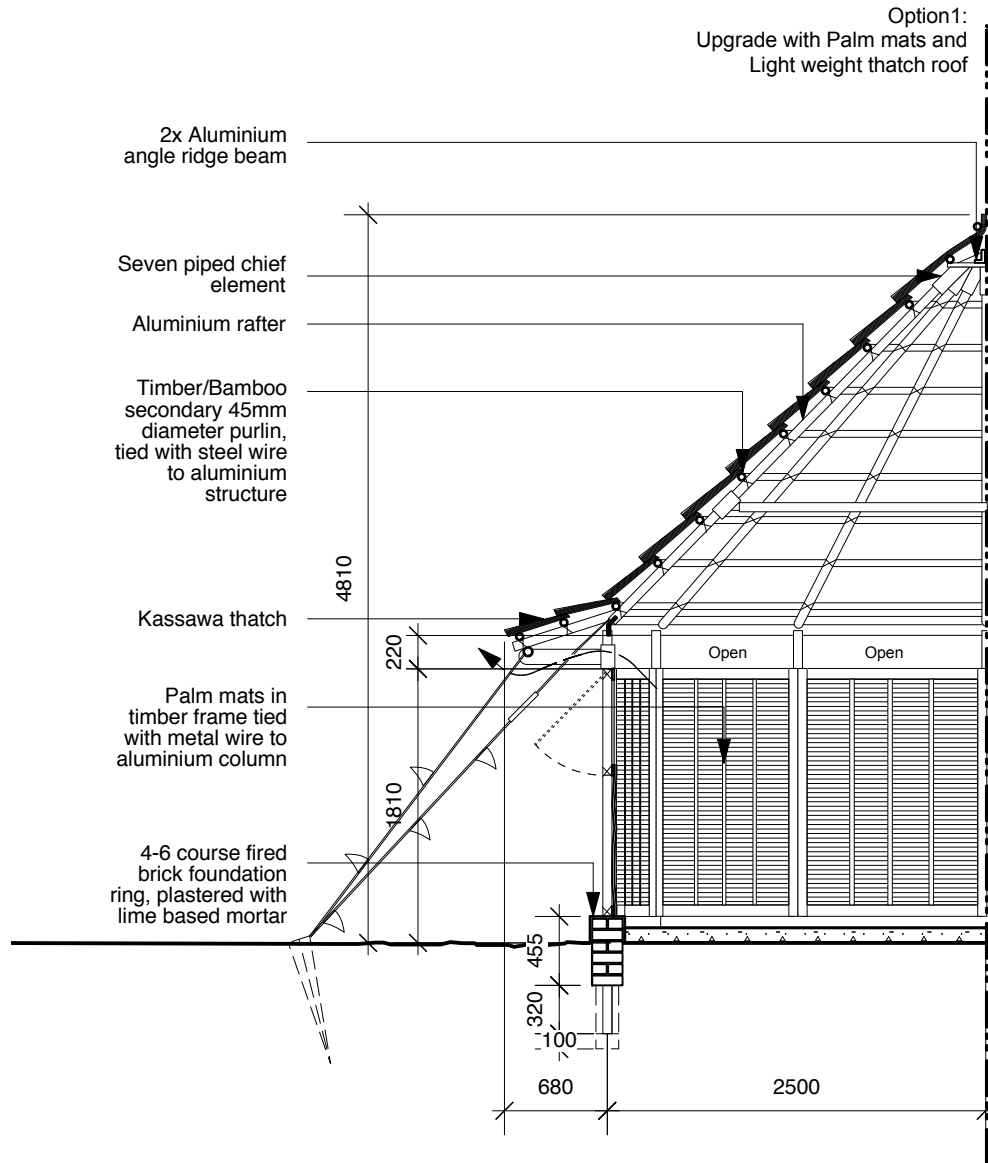


Note: drawing not to scale

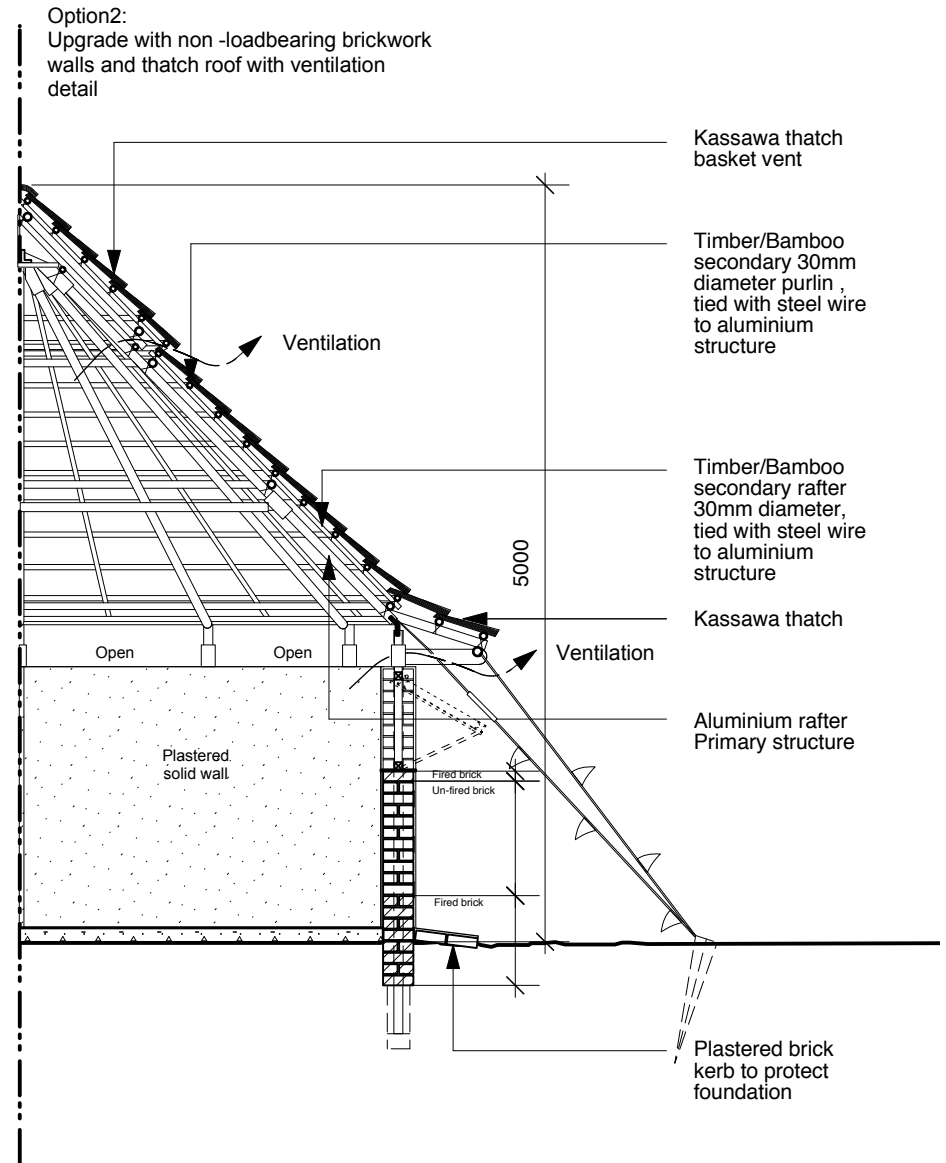


Note: drawing not to scale

Option1:
Upgrade with Palm mats and
Light weight thatch roof



Option2:
Upgrade with non-loadbearing brickwork
walls and thatch roof with ventilation
detail



Scale 1:50

Section C 5.0

Field Notes:

This is space for individual field notes, documentations and observations.



Photo: UNICEF, Myanmar

External view

MYANMAR

2008 / Cyclone / UNICEF

Agency:	UNICEF
Location:	10 townships in Yangon region and 7 in Ayeyarwady region
No. of users:	50 children and 2 teachers per TLS, approximately 410,000 primary school children/3,000 teachers
Anticipated lifespan:	1 year (withstand 3 ½ months with monsoon rain/ strong wind)
Actual lifespan:	1 year (lasts up to 3 years when renovated annually)
Facilities provided:	Temporary latrines, water ponds rehabilitated, safe drinking water and improved hygiene practice, furniture
No. of facilities:	923 TLSs: 192 tents and 731 temporary buildings
Construction time:	2 days

Main construction materials:	Bamboos, betel posts/hard woods, tarpaulin, concrete foundations
Material sources:	Locally if available, nearby townships
Approx. material cost per unit:	1,035 USD TLS by private company, 420 USD TLS by community
Approx. project cost per unit:	1,245 USD for the TLS (private contractor), 500 USD + tarpaulin (in kind) for TLSs + toilets (PTA members/community, Small Scale Funding Agreement)
Size of units:	42sqm (4.6m x 9.1m) internal dimensions
Size of construction team:	5-10 workers+2 carpenters (private company), 10-15 workers and 2 local carpenters (PTA members and community)
Construction skill required:	Carpentry and basic construction knowledge
Who built the facilities:	Local contractor, PTA and local community
Site information:	Existing school grounds

Background

On the second and third of May 2008, Cyclone Nargis swept through the Ayeyarwady and Yangon regions, affecting the lives of an estimated 2.4 million people. The official figures documented approximately 140,000 people killed or missing.

As a result, 4,106 schools were damaged and 1,255 schools were totally collapsed out of 7,257 affected schools. In addition, 450,000 homes were affected.

There were 5,000 ponds in the affected villages, many of which were inundated during the storm surge and flooded, leaving them saline and unusable. According to PONJA (Post-Nargis Joint Assessment), more than 2,000 ponds were damaged and much of the household-level rainwater harvesting capacity was destroyed together with their houses.

Project Description

The project aim was to provide support to the Ministry of Education in revitalisation education in the 2,740 cyclone affected schools within the delta area in ten townships in the Yangon Region and seven townships in the Ayeyarwady Region. This included the establishment of 923 temporary safe learning spaces of which there were 192 tents and 731 temporary buildings (418 TLSs built by private company and 313 TLSs built by the village communities) and the repair of 965 schools. This support benefited approximately 410,000 primary school children and 3,000 primary teachers.

The communities and PTA associations consulted on site selection and participated in the construction works and took over maintenance operations. The majority of transitional learning spaces were built on school-owned land within the school grounds and some within the village community. There was no concern with regards to security issues.

The project also included the construction of school appropriate temporary sanitary facilities; water ponds rehabilitated, safe drinking water and improved hygiene practice were established.

Furthermore, UNICEF distributed recreation kits, school kits, essential learning packages, textbooks and school furniture including wooden tables and benches/plastic tables and chairs.

TLS Summary

The TLS consists of a 4.6m wide x 9.1m long and 2.4m high structure of 42sqm and accommodated 50 children and two teachers. The structure was built from locally sourced materials, with bamboo/betel posts or hard wood structure and tarpaulin or thatched roof covering. The structures were either built by local contractors with a workforce of five to ten workers and two carpenters or by the local community members (10 to 15 workers) under the supervision of two carpenters both within two days.

The structures are located within areas in danger of flooding from future cyclones and high winds. Consequently, the TLS is built raised of the ground, the structural timber/bamboo columns are cast into concrete footings and cross bracing and binding wire stiffens the timber/bamboo structure elements. The tarpaulin is fastened down to the bamboo/timber roof structure by split bamboo sandwiching the tarpaulin in between. The bamboo structure was painted with crude oil to increase its durability. Regular maintenance by the community is necessary to keep the TLS safe and increase its lifespan. Actual life span was one year but increased to three years when the temporary building was renovated and maintained annually.

DRR

The main aspects to be considered is the location on higher ground if possible to protect the structure from repeated flooding as well as the secure fixing of roof covering and roof structure to the main structure to avoid the lifting of the roof sheets due to high winds.

Maintenance

- Maintenance operations were done by the PTA and local community
- Regular maintenance by skilled craftsmen of thatched roof
- Maintenance of bamboo structure/post to protect from rotting/treatment of bamboo required

Challenges

- After Cyclone Nargis local materials such as Dani/bamboo mats and hard wood was not available due to the destruction. The bamboo that was used to construct the TLSs was bought from other nearby townships
- During disaster, scarcity of artisans and skilled workers was a challenge to complete the construction of the TLSs as planned, but community participation was noteworthy though in the aftermath of the disaster

Improvements

- The tarpaulin used for roofing and the walls was fast to construct to allow schools to reopen, however it was too hot and illuminated during the daytime and did not prove to be durable under the sun and rain. Local roofing materials such as thatch and Dani (a kind of thatch available in delta) for roofing and bamboo mat for walling are available, it is strongly recommended to use those local materials for better internal temperature/natural lighting
- Consideration for second access/escape in case of fire
- Consideration to accessibility should be given in form of ramps into classrooms and latrines, width of doors. Raised walkways may be required. This is a particular challenge for raised TLSs in flood prone areas.
- Raised classroom design needs to take particular care in respect of protection from falling e.g. from walkways, stairs and openings



Photo: UNICEF, Myanmar

Internal classroom view



Photo: UNICEF, Myanmar

Children entering the new TLS



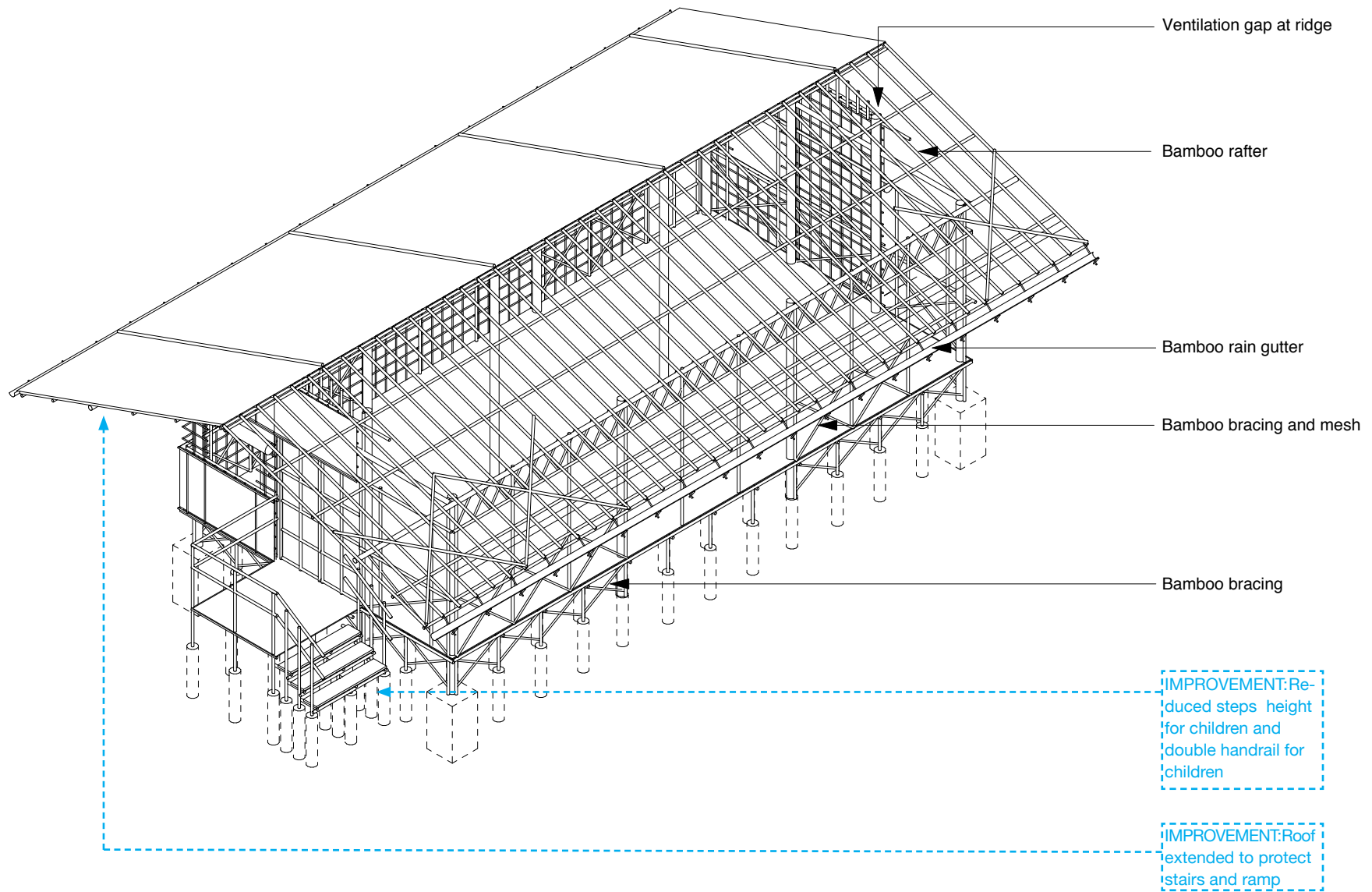
Photo: UNICEF, Myanmar

Temporary gender separated latrines

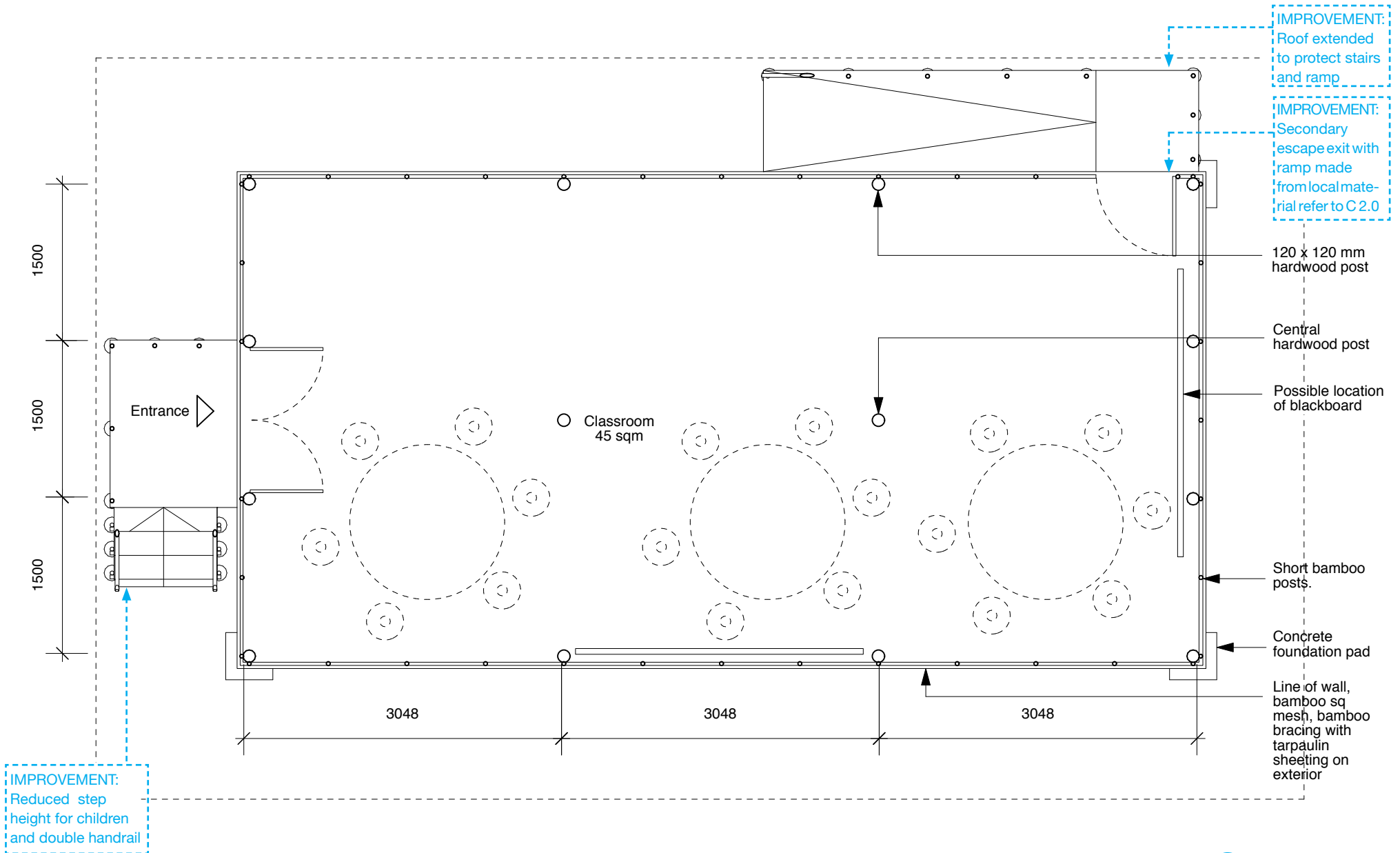


Photo: UNICEF, Myanmar

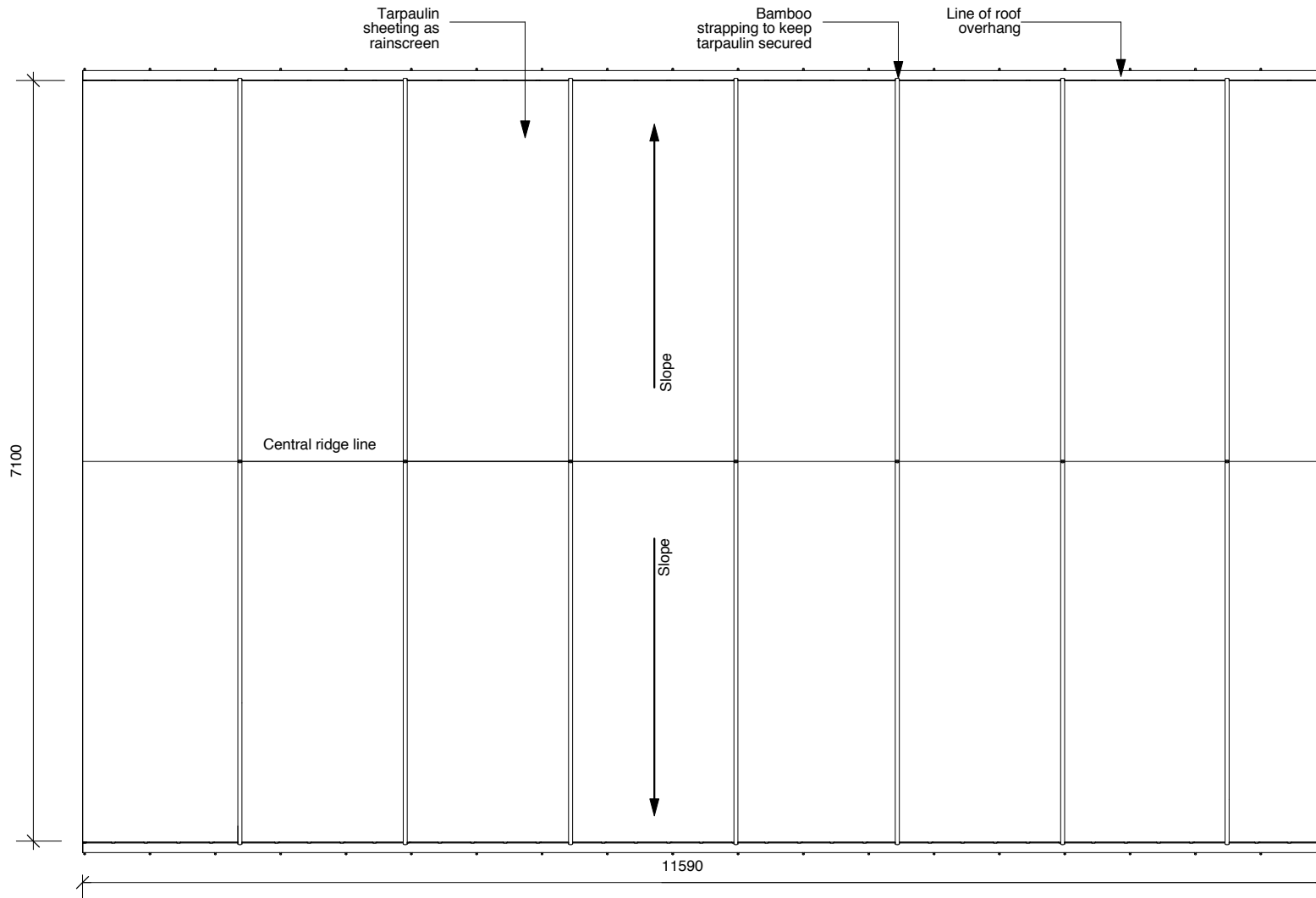
External view of TLS



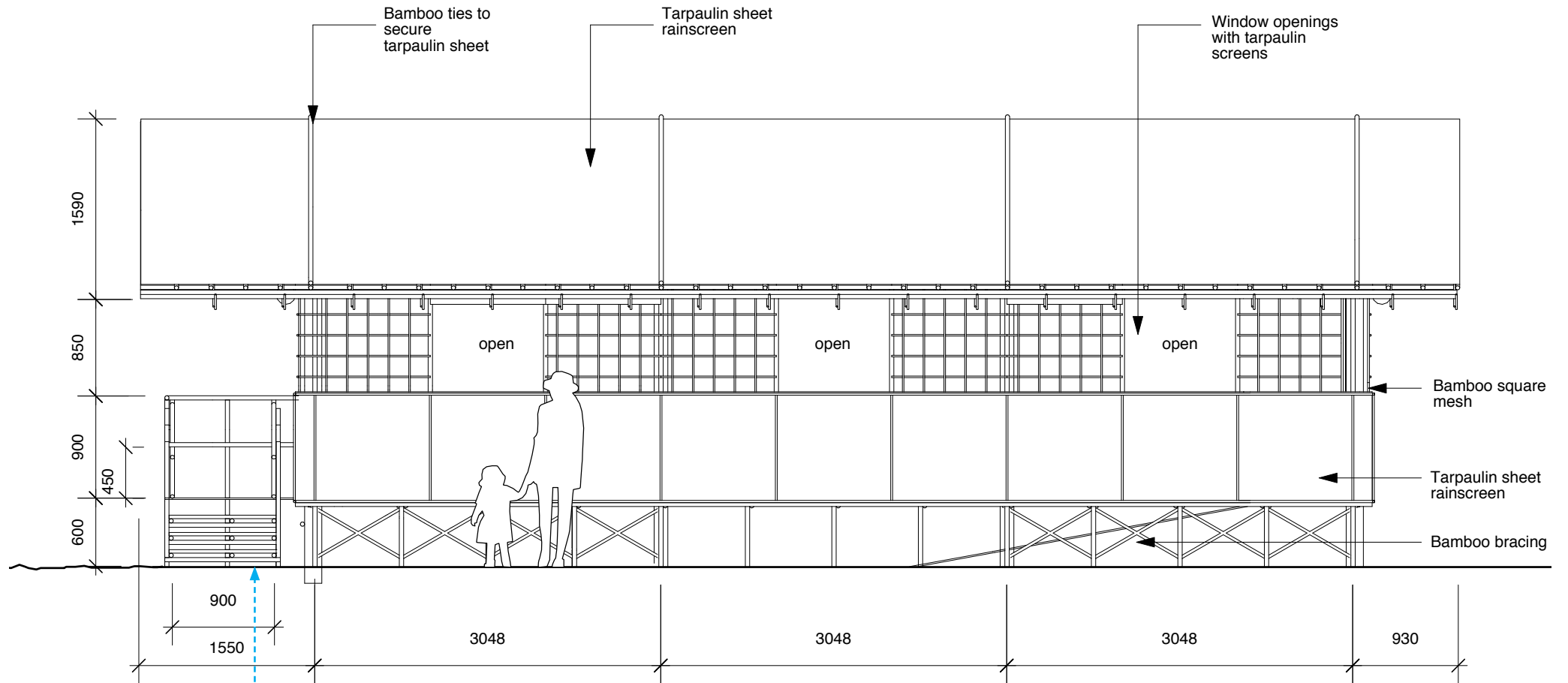
Note: drawing not to scale, for illustrative purpose only



Scale 1:50

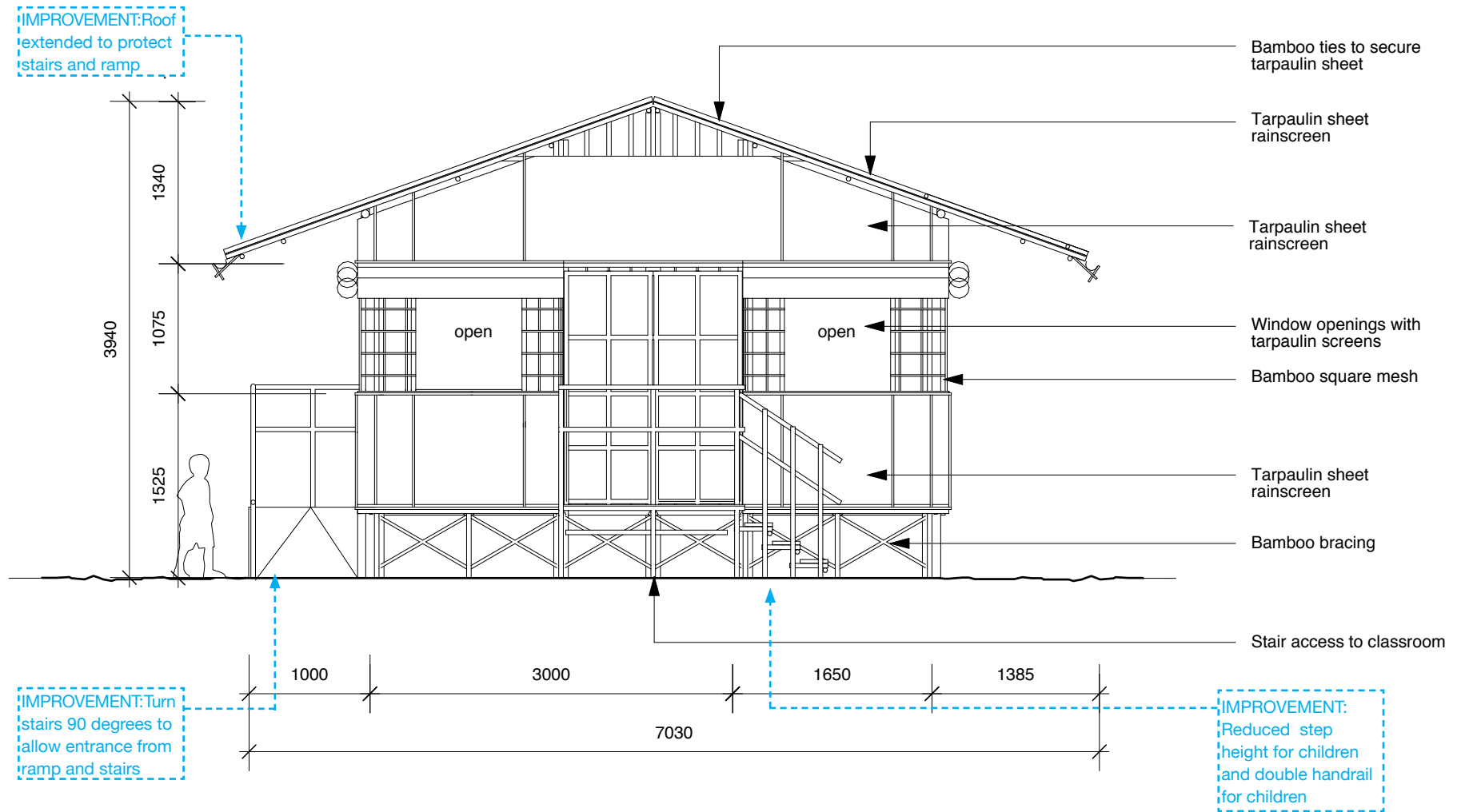


Scale 1:50



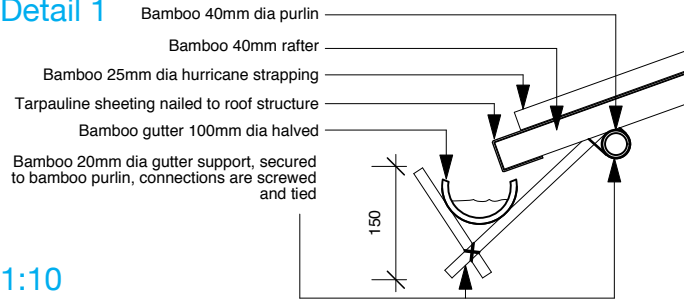
IMPROVEMENT:
 Reduced step height for children and double handrail for children

Scale 1:50

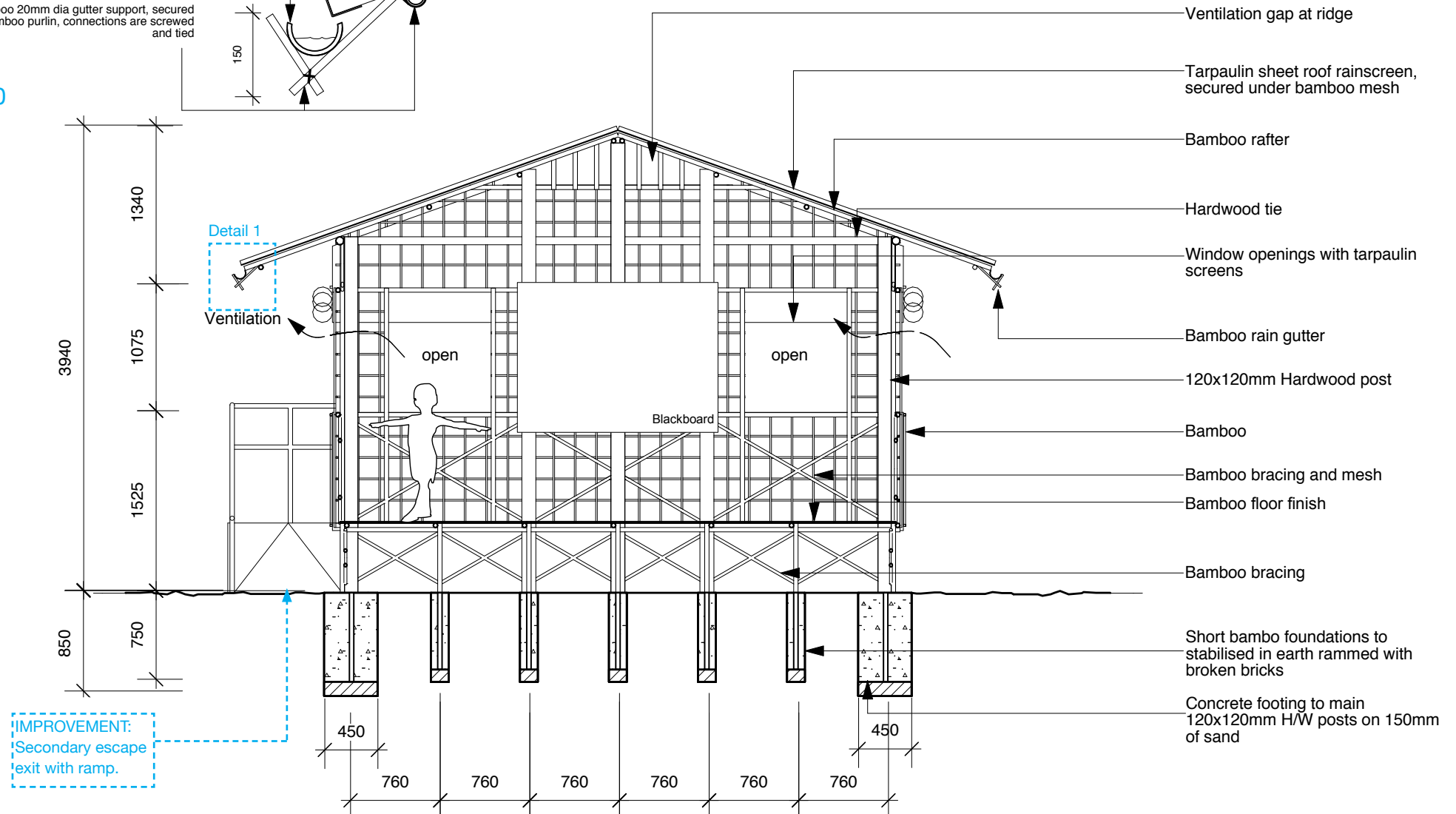


Scale 1:50

Detail 1



1:10



Scale 1:50

Quantities for single unit of 45sqm

Elements	Unit	Quantity
Main Post		
Madama Column (75mm dia.) 4.7m	no.	6
Madama Column (75mm dia.) 3.8m	no.	8
Bamboo Short Column (76mm dia.) 1.4m	no.	77
Floor		
Bamboo Joist (40mm dia.) 4.6m	no.	13
Bamboo Joist (40mm dia.) 9.2m	no.	20
Bamboo Mat Sheet (76mm dia.) 4.6m	no.	46
Walling		
Bamboo Mat (100x100mm) (75 mm dia.) 2.5m	no.	22
Bamboo Mat (100x100mm) (76 mm dia.) 4.6m	no.	12
Bamboo Mat (100x100mm) (76 mm dia.) 3.7m	no.	12
Bamboo Mat (100x100mm) (76 mm dia.) 4.6m	no.	8
Bamboo Frame (50mm dia.) 4.6m	no.	2
Bamboo Frame (50mm dia.) 2.5m	no.	8
Bamboo Frame (50mm dia.) 1.5m	no.	4
Bamboo Frame (50mm dia.) 3m	no.	12
Bamboo Frame (50mm dia.) 2.5m	no.	12
Bamboo Top Member (76mm dia.) 3.7m	no.	7
Water Proof (5x2m) for Walling	no.	10
Top Frame		
Bamboo Frame (50 mm dia.) 4.6m	no.	4
Bamboo Frame (50 mm Dia.) 3.7m	no.	6

Roof

Bamboo Mat 305x305mm (76mm dia.) 3.7m	no.	25
Bamboo Mat Sheet (76mm dia.) 3.7m	no.	96
Bamboo Frame (50mm dia.) 3.2m	no.	70
Bamboo Frame (50mm dia.) 3.7m	no.	24
Bamboo Frame (25mm dia) 0.45m	no.	120
Water Proof (6.5x4m) for Roofing	no.	4
Door & Window		
Door (2.1x1.5m)	no.	1
Bamboo Frame (38mm dia.)	no.	4
Window (0.9x1.4m)	no.	10
Bamboo Frame (38mm dia.) 4m	no.	27
Stair		
Bamboo Post (76mm dia.) 3m	no.	2
Bamboo Frame (50mm dia.) 1.8m	no.	12
Bamboo Mat Sheet (76mm dia.) 1.5m	no.	6
List of Tools		
Hammer		2
Hand Saw		2
Pliers		2
Sword		4
Adze		2
Shovel		2
Iron Rod Spade		2

Field Notes:

This is space for individual field notes, documentations and observations.



External view

SOMALIA

2010 / IDP Camp / NRC

Agency:	Norwegian Refugee Council – NRC
Location:	Mogadishu and Afgooye corridor, Somalia.
No. of users:	Targets 40-45 students per classroom. Used in shifts where demand is high
Anticipated lifespan:	Four to five years
Actual lifespan:	Those constructed in February 2010 are still intact. There are no others constructed before then
Facilities provided:	Classrooms, head teachers office and stores, latrines and drinking water
No. of facilities:	13 temporary classrooms and five stores (and offices) in seven different centres located in Mogadishu and Lower Shabelle

Construction time:	One week
Main construction materials:	Galvanised corrugated iron sheets, timber, nails, cement, gravel and sand for flooring
Material sources:	All locally sourced from local suppliers/businessmen. Iron sheets and timber imported by local businessmen / traders. The gravel and sand are locally sourced, from natural sources.
Approx. project cost per unit:	2,500 USD
Approx. material cost per unit:	1,750 USD
Size of units:	Classroom: 8.0m x 6.0m wide, office and store: 2.0m x 6.0m
Size of construction team:	Six construction workers
Construction skill required:	Basic construction knowledge of carpentry, corrugated iron sheets and concrete works
Who built the facilities:	Built by NRC, using local craftsmen and labour from the beneficiary IDPs community
Site information:	Secure land tenure is the main challenge

Background

Since 1991, when the last effective central government fell, Somalia is characterised by mass internal displacement due to natural disasters and on going conflict between armed opposition groups battling the Transitional Federal Government. Inside Mogadishu and to the west of the city, famously referred to as the Afgooye corridor, displaced children live with their families in self settled informal settlements.

Project Description

As part of NRC's Alternative Basic Education programme (ABE), transitional learning centres were envisioned to provide safe and child-friendly learning spaces for displaced children living within communities in self settled informal settlements. Initially, NRC provided large imported learning tents for their ABE education programmes. These tents were procured at a cost of roughly \$7,000 with a lifespan of less than two years. The skill for maintenance and repair works for these tents was not locally available and the transitional learning spaces were designed to replace the imported tents with longer lasting and locally sourced and maintainable materials.

The initial request for the construction of the transitional learning spaces was made by the community, through the Community Education Committees (CECs). The CECs were a key partner in locating possible sites for the facilities, providing free labour for the construction and providing security for the materials and construction crew during the construction process. On completion of the TLC, the facilities were handed over to the CECs for management and maintenance.

A key issue was the security of tenure for the temporary learning centres. The displaced communities usually have no security of tenure for the land on which they have built their shelter. Consequently, the constant threat of eviction and further displacement was present, should the landlords decide to sell the land.

TLS Summary

A key design priority for the transitional learning centres was a ventilated, comfortable and safe learning space within the local hot and humid climate. The internal climate in the imported tents had been too hot due to solar radiation. Another key priority was to be able to maintain the structure with locally available construction skill. The TLS accommodates two classrooms of 6m x 8m (48sqm) with an enclosed head teacher's office/store room of 2m x 6m in between. This layout gives a good acoustic separation between the two classes and prevents class activities disturbing each other as well as a safe storage space and centrally located teachers' space.

The main structure is made from hardwood timber. The timber uprights are cast into concrete foundations and are treated against termites with engine oil. The windowsill-height half walls are constructed of painted iron sheets nailed to a timber substructure with bracing. These half walls were prefabricated at a warehouse and delivered to site, where they were nailed to the main timber structure. These half walls were used as shutters for pouring the concrete floor in situ on a compacted gravel base, so no foundations under the walls were constructed to minimise the concrete usage. The roof is a hip roof made from GCI sheeting nailed to the timber structure and with roof ventilation to reduce heat build up under the GCI sheeting. It has an overhang of one metre around the perimeter to reduce rain and direct sunshine reaching the inside of the classroom. The timber roof structure is fixed back securely to a continuous timber wall plate at a high level. There are two entrances to each classroom to allow flexibility and fast escape routes.

An important aspect was the need to be able to reuse the construction materials. In one location, one temporary learning centre had to be pulled down after the landlord sold the land. The community then requested NRC to support the relocation of the learning centre, which involved pulling down the structures and recycling the materials on the new site.

Maintenance

The Community Education Committees were in charge of the maintenance operations.

Challenges

- Security of land tenure was the main issue within the informal IDP camp
- In comparison to the tent, there is the risk that it could be pulled down by people keen to reuse the iron sheets and timber for their individual shelter, as they were of lower quality construction.

Improvements

- Consideration to accessibility should be given in form of ramps into classrooms and latrines, width of doors.



Photo: NRC

Internal view of TLS with education in progress



Photo: NRC

View of shelters within IDP camp



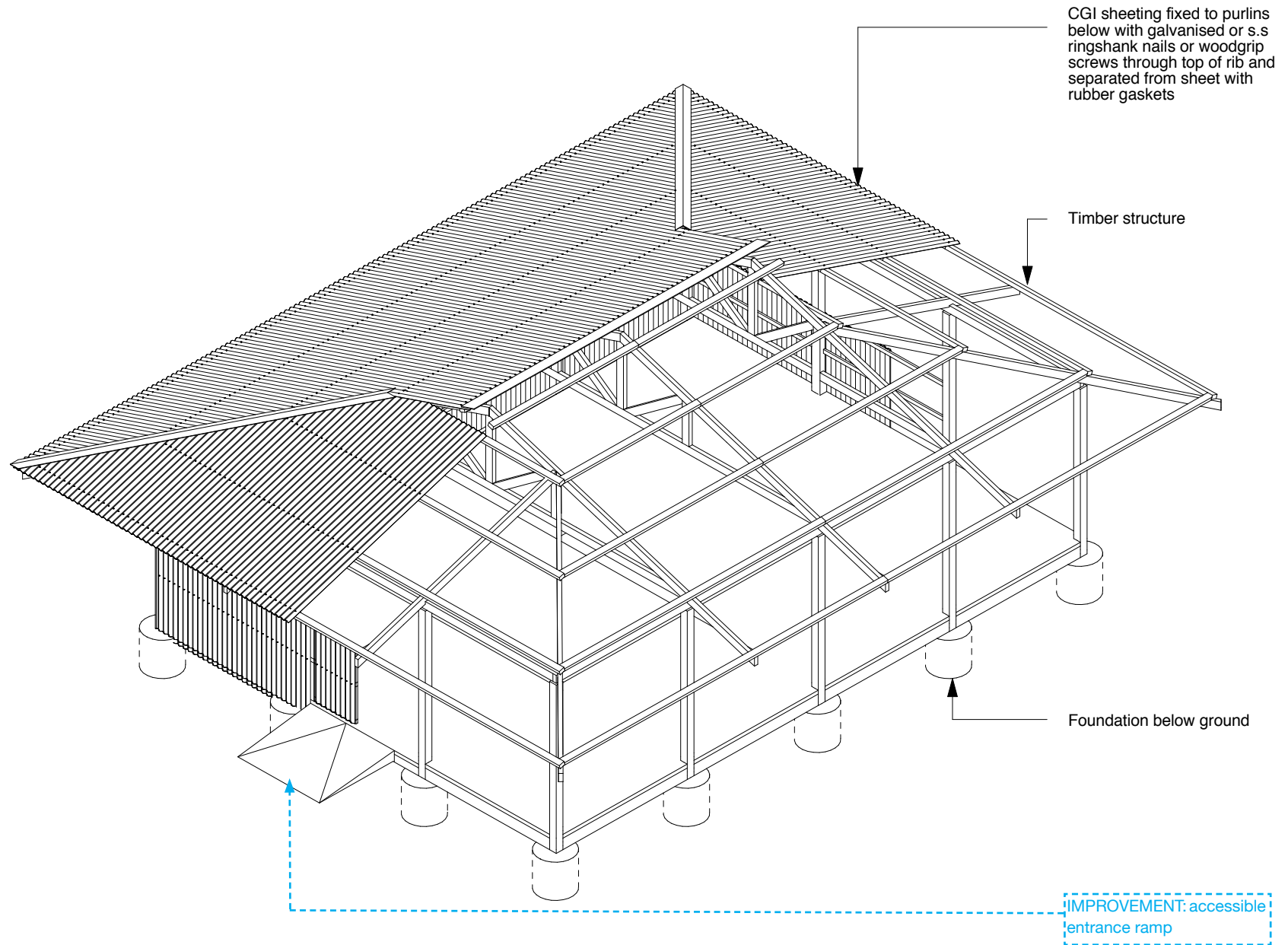
Photo: NRC

External view of TLS

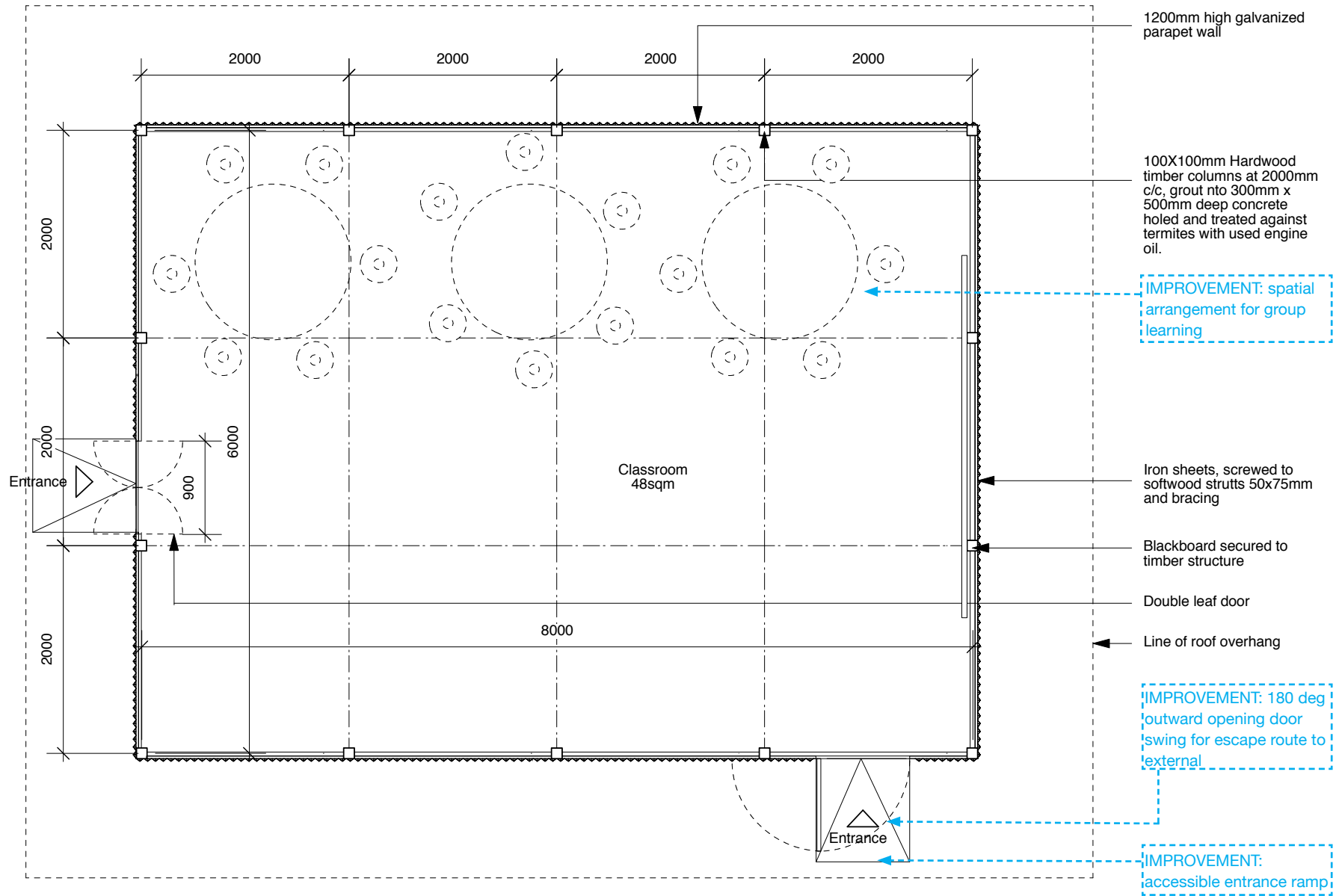


Photo: NRC

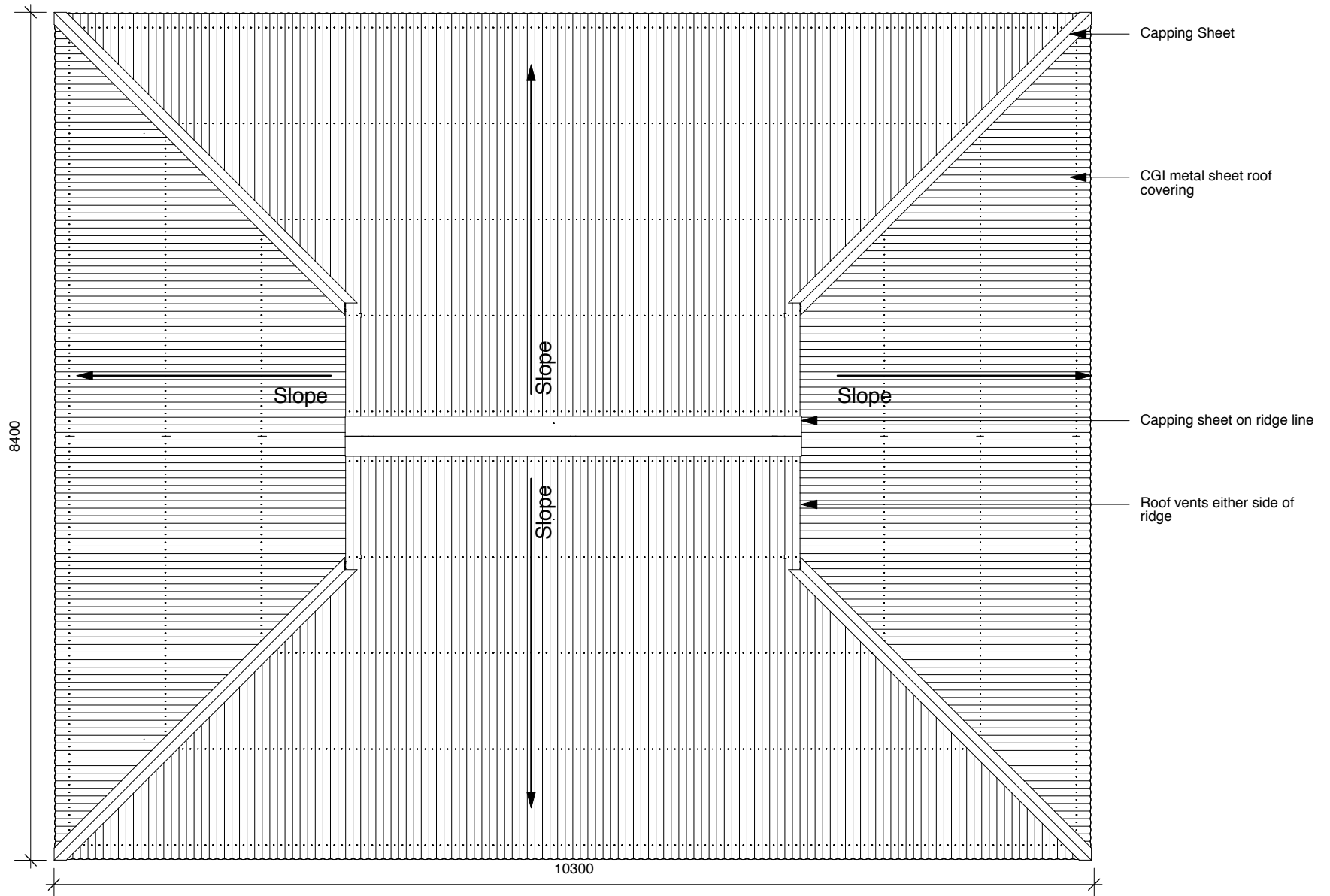
Roof ventilation detail



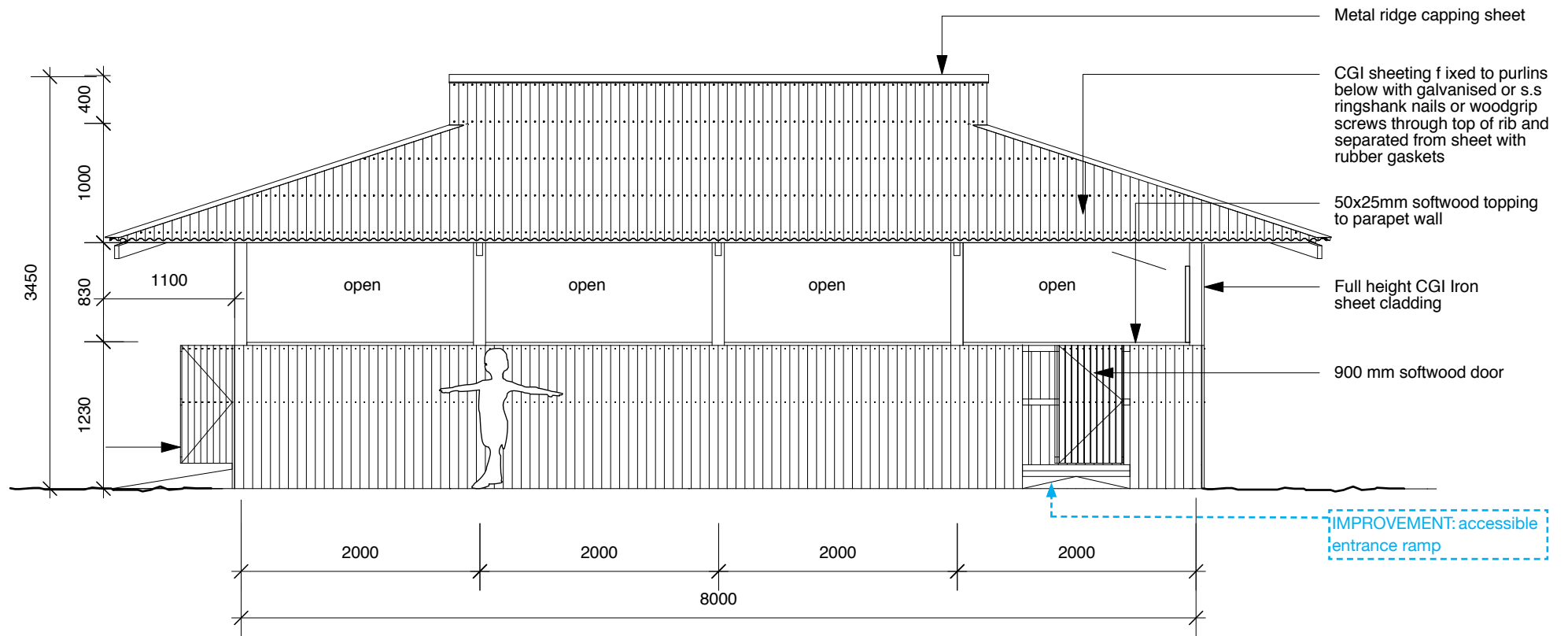
Note: drawing not to scale, for illustrative purpose only



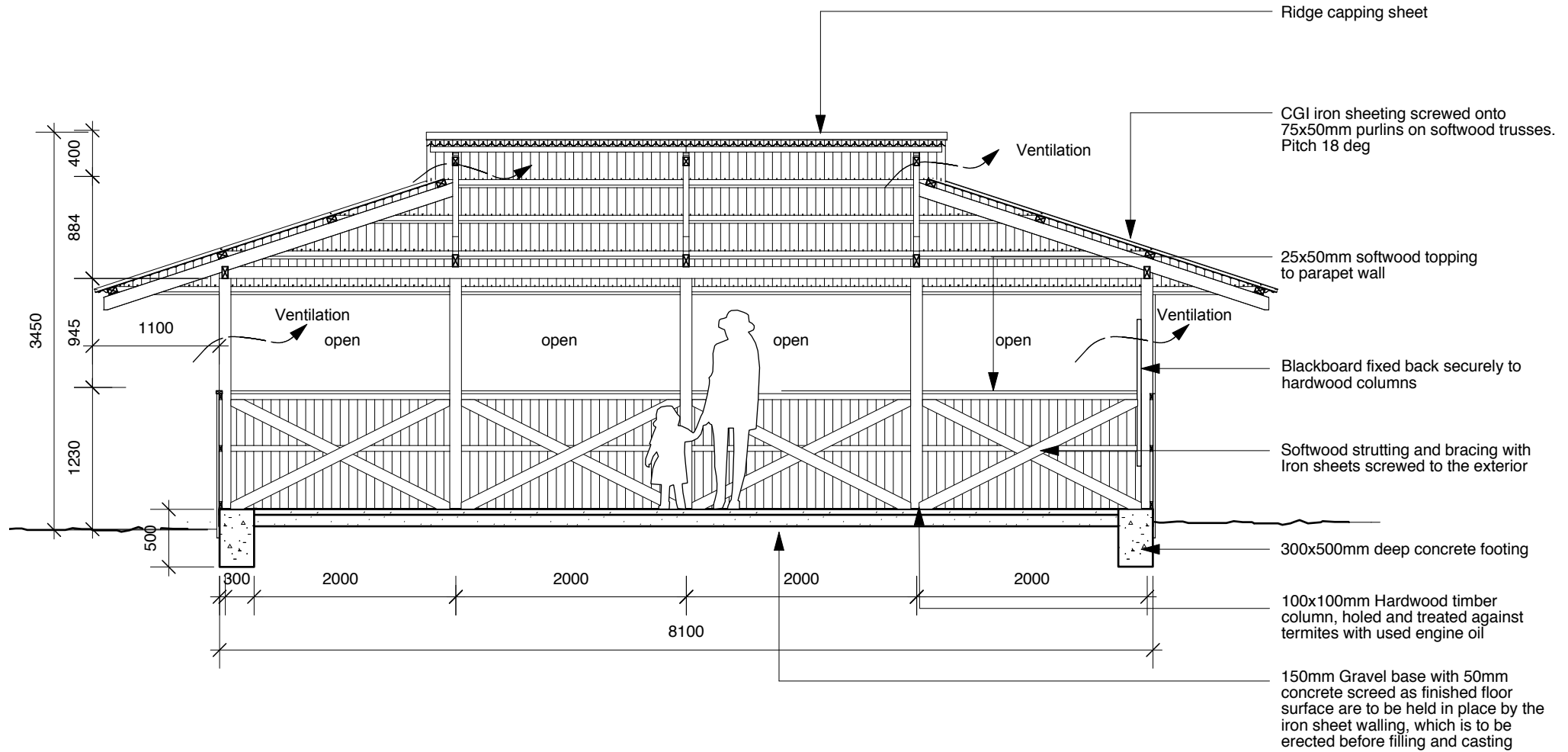
Scale 1:50



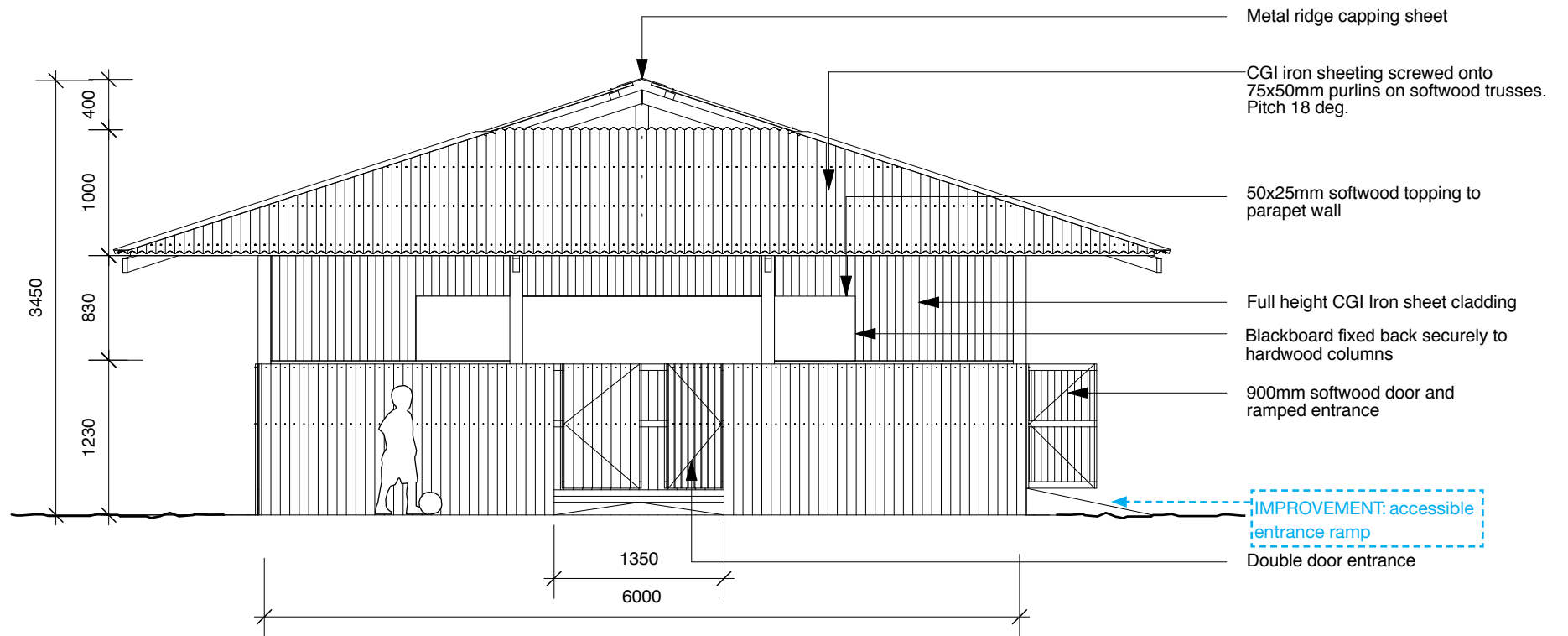
Scale 1:50



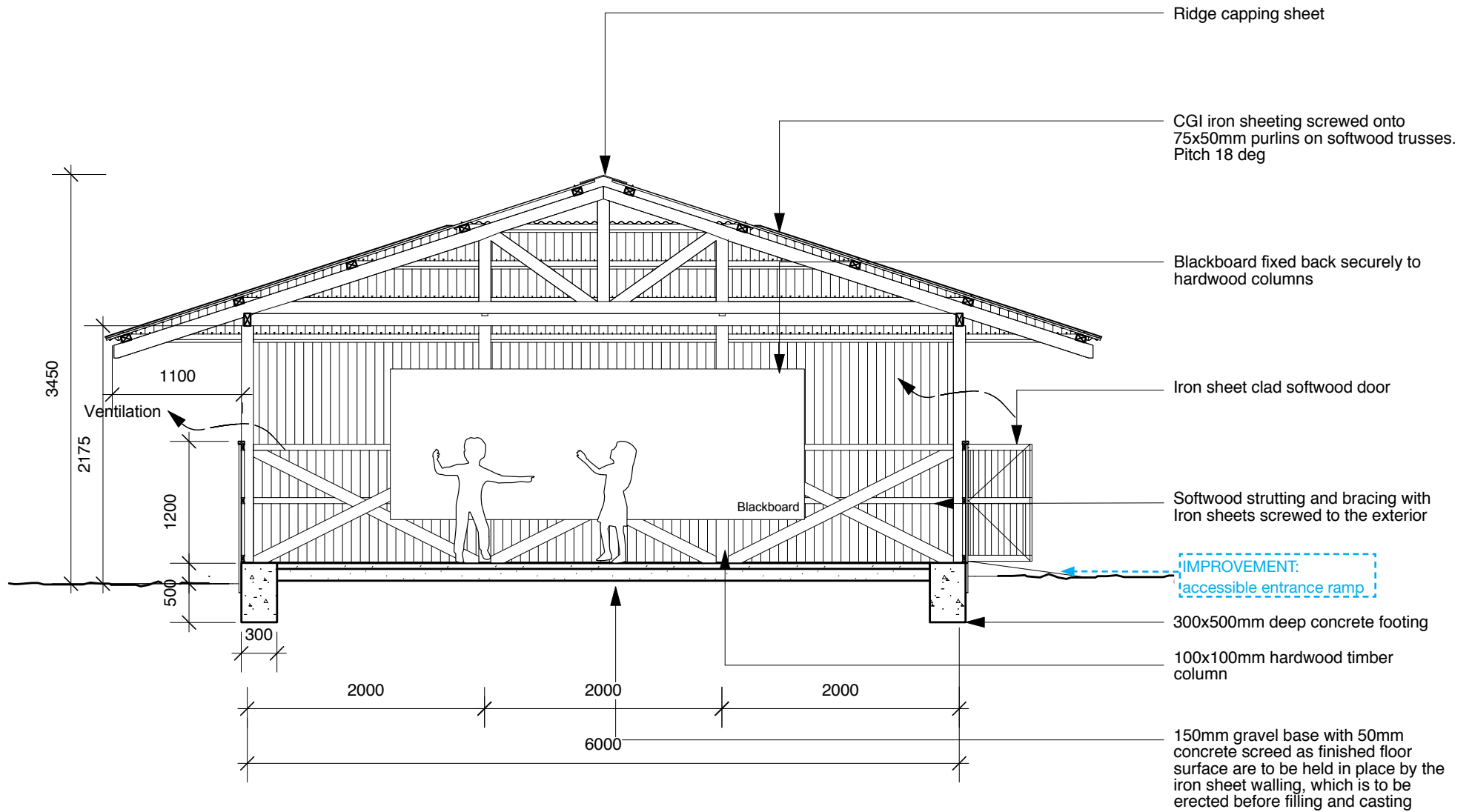
Scale 1:50



Scale 1:50



Scale 1:50



Scale 1:50

Quantities for single unit of 48sqm		
Element	Unit	Quantity
Foundation		
Cement	bags	13
Water	drums	12
Sand	load	1
Aggregate	load	1
Crushed stone sand	load	2
Walls		
Corrugated iron sheet	no.	100
Timber size 80x80x2000mm	no.	14
Timber size 80x40x2000mm	no.	14
Timber size 50x25x2000mm	no.	48
Timber size 100x25x2400mm	no.	24
Roof		
Corrugated iron sheet	no.	100
Timber size 80x40x2000mm for purlins	no.	54
Timber size 100x50x2000mm for 3 trusses	no.	28
Timber size 100x50x2000mm for 4 rafters	no.	7
Other materials		
Nails/ screws	kg	12
Door locks	no.	2
Door hinges	no.	4
Wood preservative	lts	15
Red oxide paint	kg	45
Thinner	lts	10

Section C 7.0

Field Notes:

This is space for individual field notes, documentations and observations.



Photo: UNICEF, Bangladesh

External elevation of the school option 2

BANGLADESH

2007 / Cyclone / UNICEF

Agency:	UNICEF / Local NGOs in collaboration with School Management Committees Coastal districts of Bangladesh
Location:	Cyclone Sidr affected coastal areas
No. of users	17,040 children/approx. 426 staff 40 children per classroom, 120 per school
Anticipated lifespan:	10 years, designed for a wind speed of 80kmph
Actual lifespan:	Schools are still being used
Facilities provided:	3-5 classrooms per school, 1 outdoor activity/play/ extended class space, front veranda, administration office, sanitation facilities and hand washing+drinking water facilities (water tank of 500 litres)
No. of facilities:	142 schools with facilities mentioned above

Construction time:	Typically 30 days, depending upon local conditions such as access roads, mode of transportation, availability of local materials and manpower etc. extended to max. 3 months
Main construction materials:	Local brick, bamboo, bamboo mat, local timber, corrugated galvanized 0.45mm thick iron sheets, false ceiling with local tree leaves, main supporting system had two options, a) locally available precast concrete posts or b) local timber posts
Material sources:	Locally sourced, small quantities of steel and cement were transported from Dhaka
Approx. project cost per unit:	3,000-4,982 USD per school, includes transportation of materials, teaching learning materials and 10% service charges and miscellaneous- outdoor sitting, wind guard wall, landscaping, etc.
Approx. material cost per unit:	68% were material cost
Size of units:	48sqm; school: 146sqm,
Size of construction team:	2 skilled masons + 4 unskilled labourers and one carpenter with 2 helpers, 4 school management committee members (honorary)
Construction skill required:	Masonry, RCC, carpentry for joinery works
Who built the facilities:	NGO, Local craftsmen, local community
Site information:	Sites had various conditions with different hazards ranging from high cyclone, earthquake, tidal wave and severe floods

Background

Bangladesh was struck by Cyclone Sidr, a category 4 cyclone, on 15 November 2007, which created immense destruction in the affected communities in terms of human lives lost, materials destruction and destruction of livelihood. Housing damages represent the most visible and tangible damages associated with Cyclone Sidr. According to the Government of Bangladesh sources, the total number of houses damaged stood at over 1.5 million (37% fully damaged and 63% partially damaged).

According to Government of Bangladesh data Cyclone Sidr destroyed 760 primary schools including governmental schools, NGO and community schools, disrupting the education of 1.25 million children. The affected schools lost their sanitary units and drinking water systems got badly damaged and contaminated. Increased salinity caused major problems with safe drinking water supply.

Project Description

The estimated time required for the construction of the permanent structures which were designed to be Cyclone Shelters and schools was 18 months that time. Unfortunately, the permanent structures were completed only this year during which time the transition schools have remained in operation.

The objectives of this UNICEF project were to provide transitional learning spaces that were safe and more child-friendly, to prevent an increase in drop-out rates due to prolonged period of inadequate education facilities and supply WASH facilities with 500 litre water tanks per school and school appropriate sanitation facilities. In addition, the project aimed to develop a community-based infrastructure delivery mechanism to create livelihood opportunities in construction for the local community. Community participation was a key component in the project from needs assessment to implementation including construction-training activities.

Within this context, it is important to mention that due to tremendous community efforts, initiatives and their quick response, the need for constructing new transitional learning spaces was reduced to 128 primary schools from 760 originally affected schools, as well as 75 sanitation facilities and 103 safe drinking water systems. The other schools resumed their classes in rehabilitated buildings. In addition to the community efforts the government provided resources to the local community to repair damaged schools through a government funded community implemented initiative.

Key elements for the success in this project were community participation and rigorous construction administration by local architects in charge of the design and construction, as well as providing opportunity for technology transfer by employing the local community. Many such schools faced the Cyclone Aila in May 2009, which was 250-350km wide with wind speeds exceeding 120kmph, with minor damage and schools reopened after a few days. The project funding was provided by Sida.

TLS Summary

There are two design options that have been implemented after Cyclone Sidr by UNICEF. These gave different variations in construction techniques and spatial arrangements. Both options are particular in proposing a spatial arrangement of several classrooms, an external play space, administrative facilities and WASH facilities. Sanitation facilities and provision of safe drinking water supply (tank of 500 litres) were provided by WASH section and strategically located for safe use for girls and boys. Each school was supplied with teaching learning materials and materials for games such as football.

Both design options are cyclone resistant constructions with timber cross bracing between structural posts, secure fastening of timber post to foundations, screwed down GCI roof sheeting and shallow roof pitch. The overall building is situated on a raised platform to avoid flooding. The schools maximise the north south wind movement for ventilation and capture local cultural tradition in the design.

Option 1 included three to five temporary classrooms with a raised outdoor activity/play and raised front veranda made from compacted earth and bamboo floor finish. The raised platform is accessible by a ramp. Each temporary school had the capacity for 120 children (40 per classroom), the classroom size is 6m x 8m (48 sqm). The building's main support structure has two options: a) locally available precast concrete posts, or b) local timber posts on concrete pad footings. The wall cladding is bamboo mats (tarja) fixed in between timber posts. The roof is constructed from 0.45mm thick corrugated galvanised iron sheets on Loha/Garjan Kath roof structure with a tree leave cladding as an internal ceiling. A curved brick balustrade wall with child height benches is located along the whole length of the building where children can gather and play.

Option 2 included three temporary classrooms and one administrative office with a covered raised front veranda. The external play veranda is accessible by a ramp and has child height seating incorporated into the balustrade. The raised platform on which the building is standing is made from brick with a screed finish. Each temporary school has the capacity for 120 children (40 per classroom). The classroom size is 6m x 8m (48sqm). The building's main support structure is from locally available timber posts fastened to the foundations by metal straps. The corrugated galvanised iron sheet walls cladding is fixed to an external face of timber structure. The roof is constructed from 0.45mm thick corrugated galvanised iron sheets on a timber roof structure with a tree leave cladding as an internal ceiling.

The construction for both design options took on average approximately 30 days with community participation and construction training. Depending upon the local conditions such as access roads, mode of transportation, availability of local materials and manpower, construction time could extend to three months. The construction materials were predominately sourced locally. Small quantities of steel and cement were transported from Dhaka to the sites.

Maintenance

- Maintenance operations were done by PTA + local community
- Regular treatment of the bamboo/timber structure is required to prevent rot
- Regular check of securing roof sheeting connection to roof structure

DRR

It is important to high light the comprehensive approach taken by BCO to help construct the Transitional Learning Space as well as advocated for the use of the funds from the Sector Wide Programme to construct School/Cyclone Shelters, thus providing a sustainable solution to the reoccurring flooding. In addition the location and siting of the school was changed as part of the disaster risk reduction measures.

Improvements

- Continuation of the raised platform to include the wash facilities. to make accessible
- The improvements of insulating the roof to achieve more comfortable internal temperature could contribute to upgrading the TLS into a semi-permanent structure.



Photo: UNICEF, Bangladesh

External view of option 1 design timber structure with CGI sheeting wall covering



Photo: UNICEF, Bangladesh

Internal view of option 1 TLS, good example of child-friendly learning space with natural lighting, ventilation and adequate space



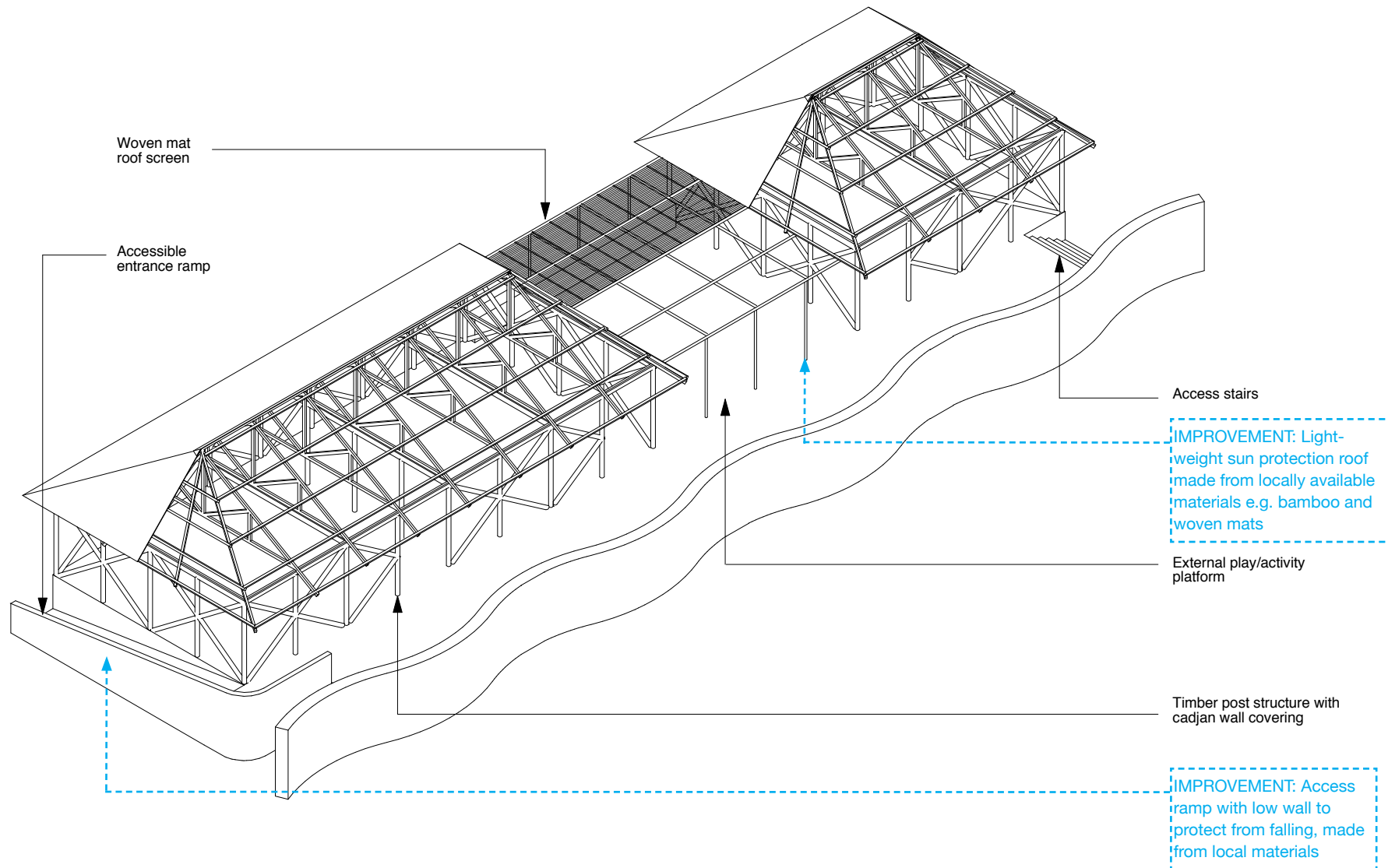
Photo: UNICEF, Bangladesh

Internal view of option 1 TLS, children in group learning exercise

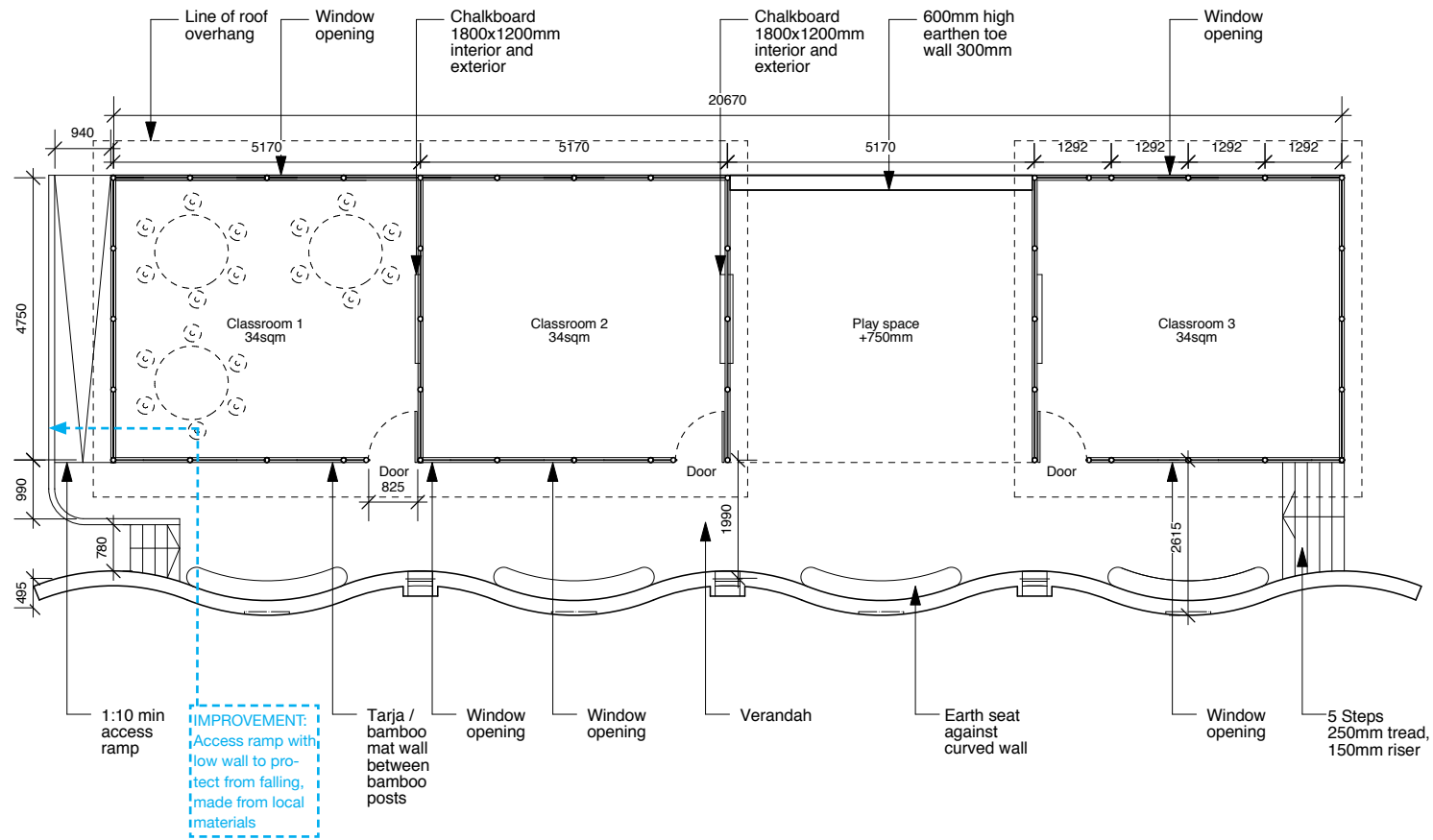


Photo: UNICEF, Bangladesh

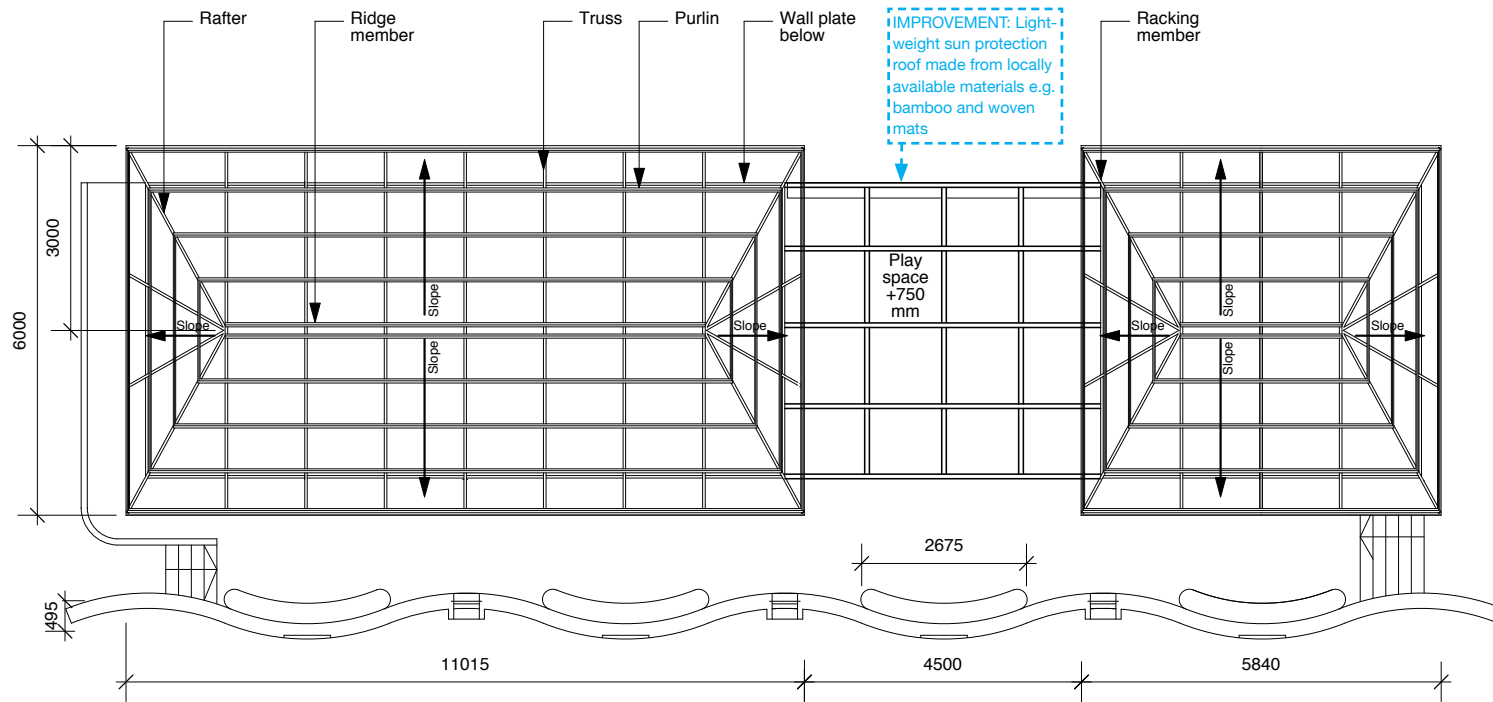
Internal view of option 1 TLS, good example of child-friendly learning space with wall space for showing posters and learning material



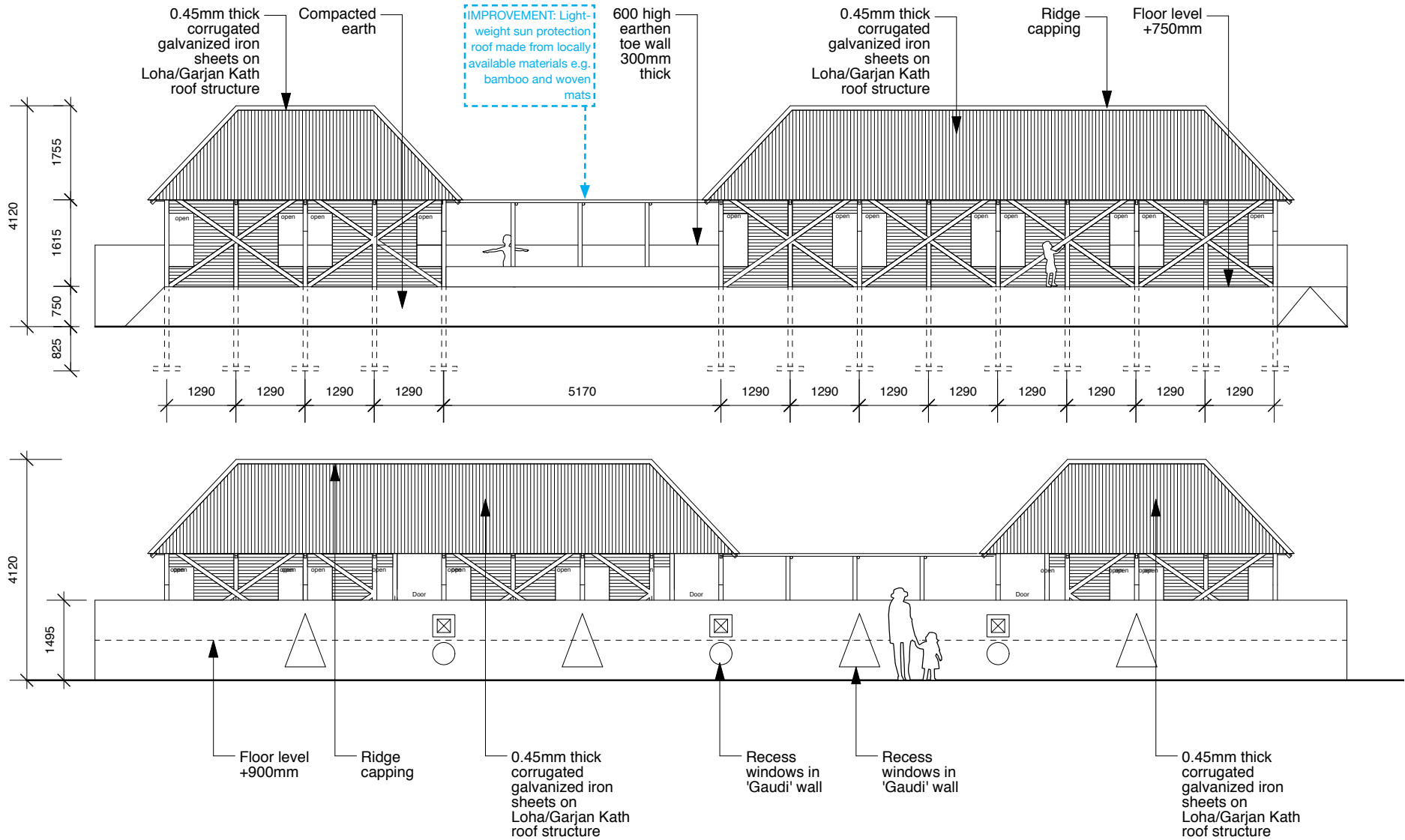
Note: drawing not to scale, for illustrative purpose only



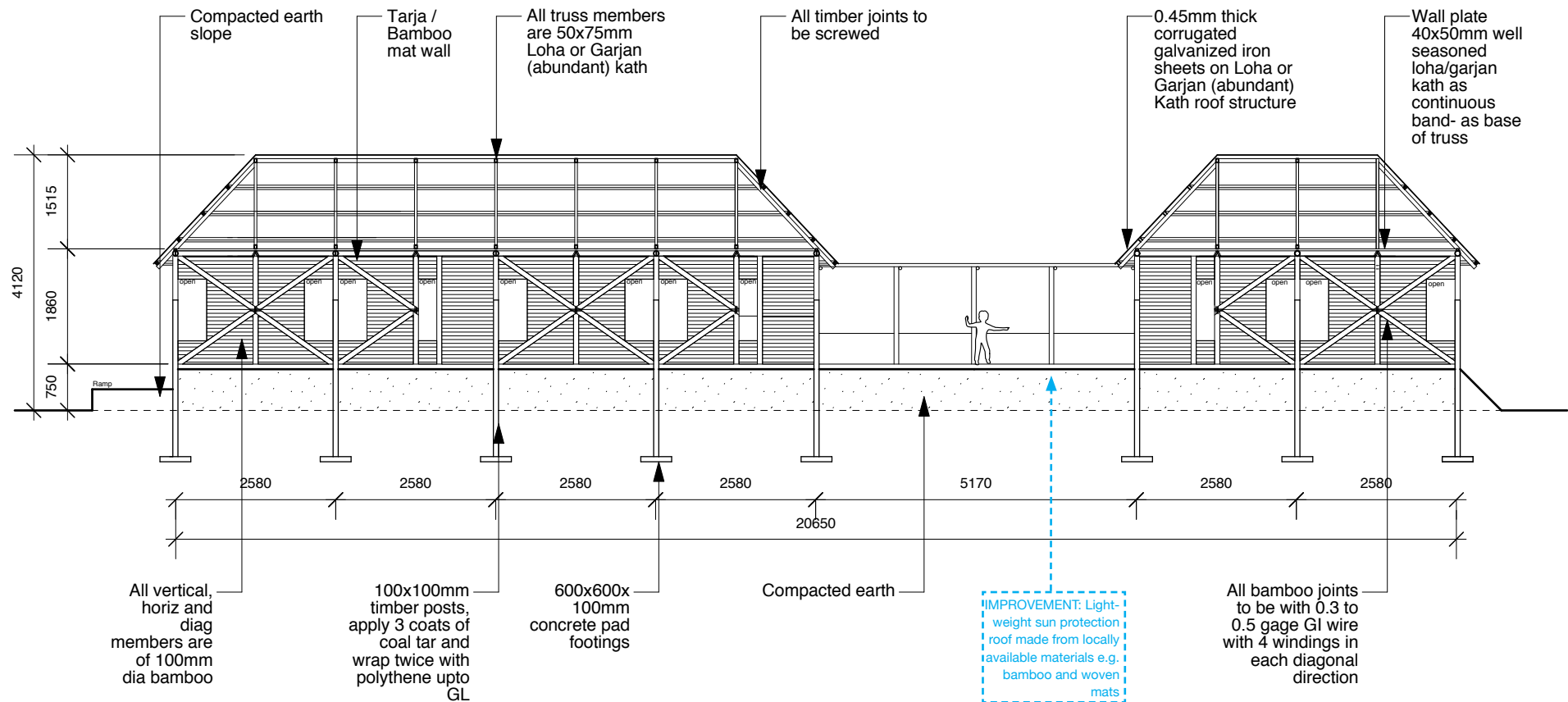
Scale 1:100



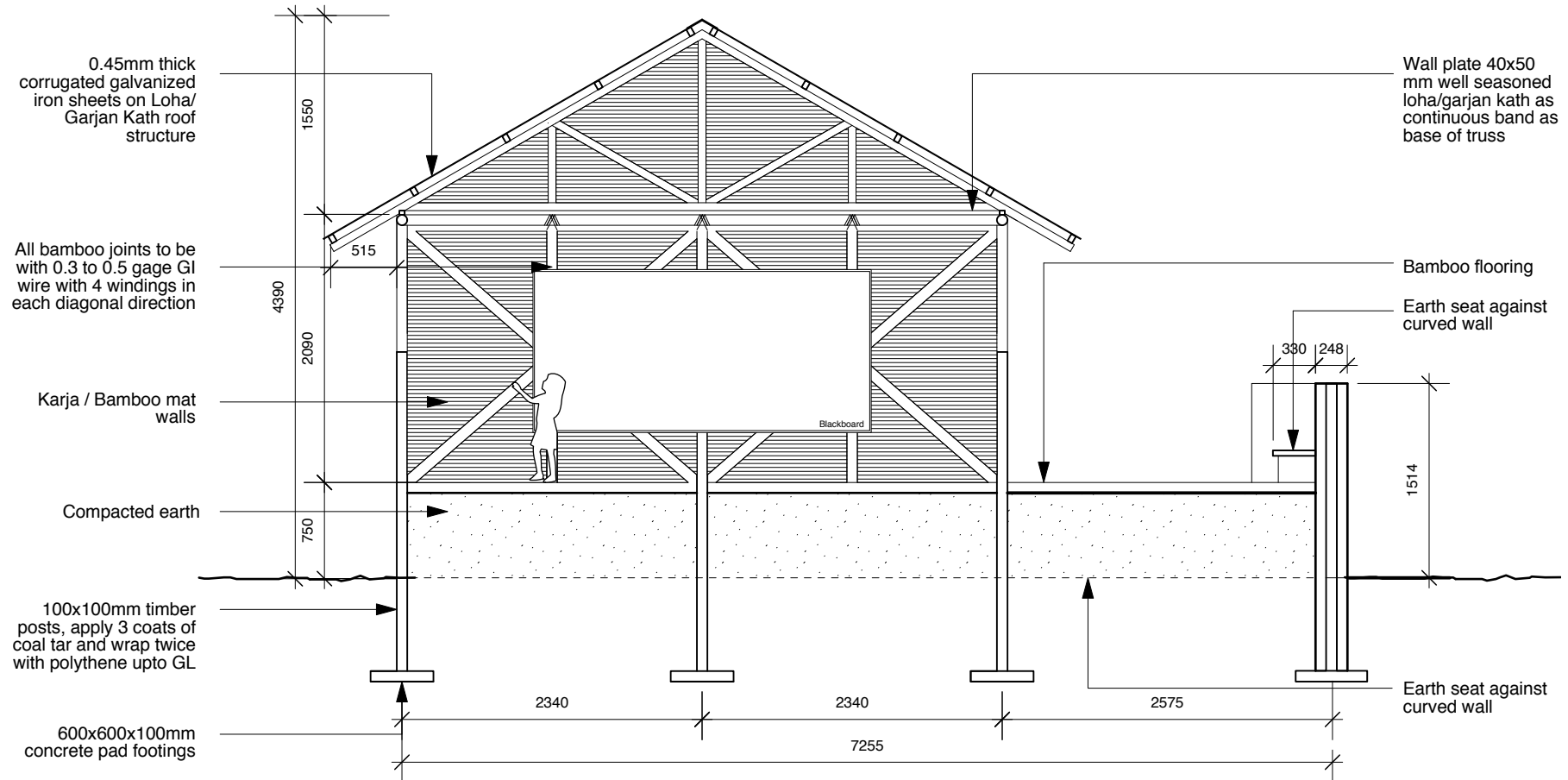
Scale 1:100



Scale 1:100



Scale 1:100

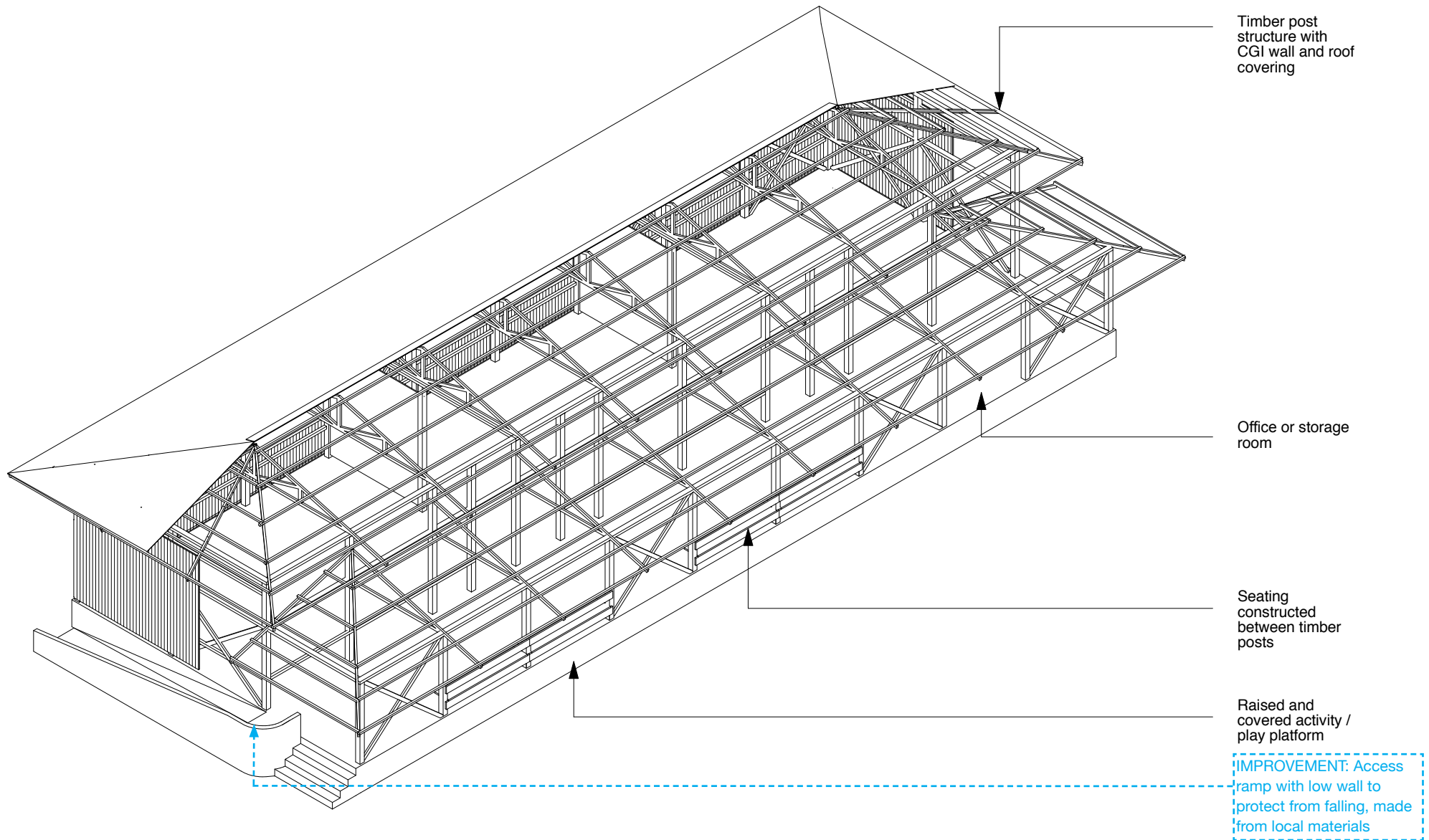


Scale 1:50

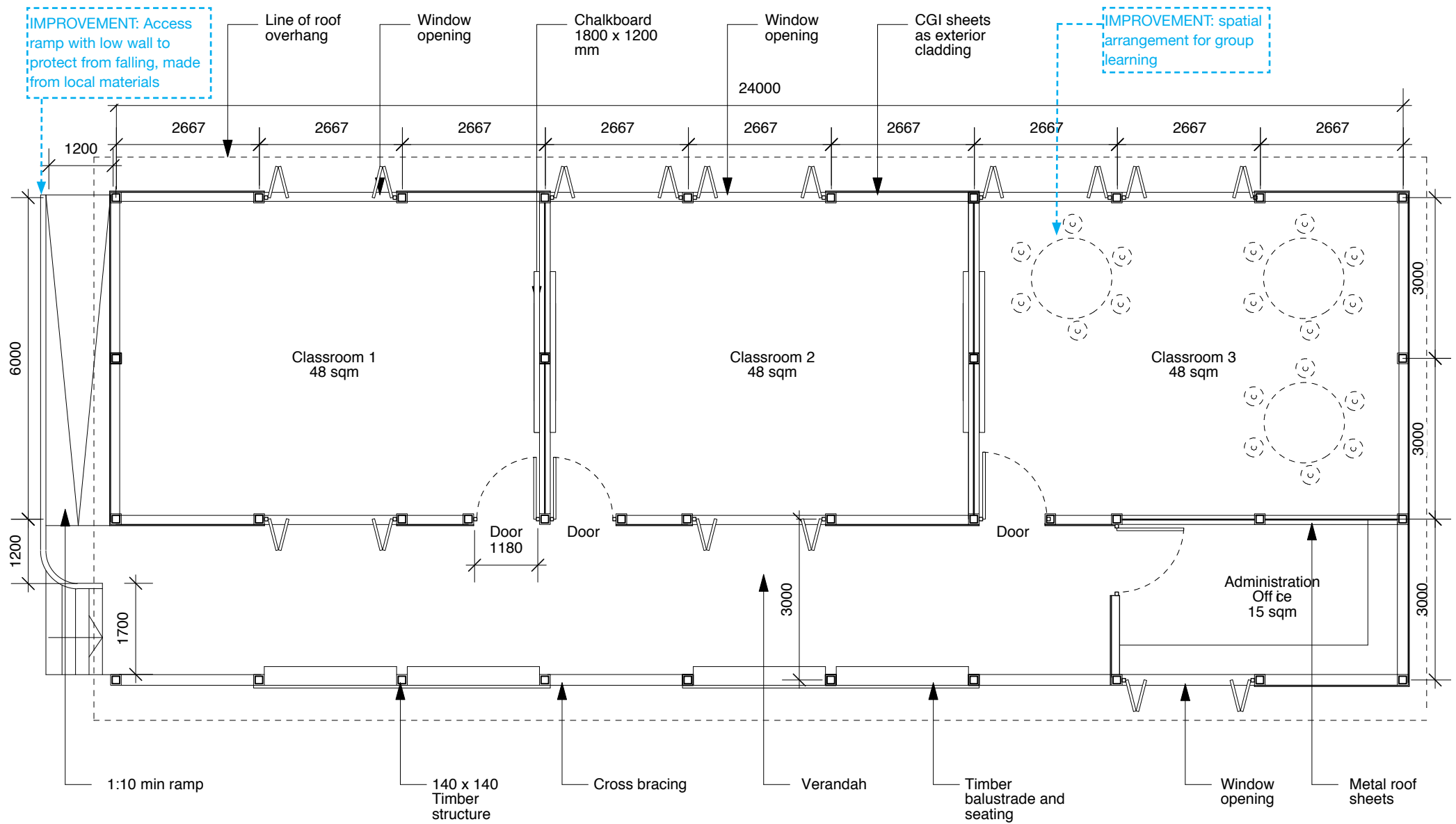
Quantities for 3 units, 34sqm each

Element	Unit	Quantity
Excavation and Earthwork		
Mobilisation/Layout	L.S *	1
Foundations		
100x100mm timber posts (3000mm)	no.	48
Tar (to coat each timber post)	lt	10
Polythene (to wrap each timber post)	m ²	48
Concrete pad footings (600x600x100mm)	no.	48
Compacted earth	m ³	195
Floor		
Bamboo mat flooring	m ²	110
Walls		
100 dia. bamboo cross bracing (3700m)	no.	28
100 dia. bamboo cross bracing (1850m)	no.	17
100 dia. bamboo posts (2100m)	no.	40
0.3-0.5 gauge GI wire (to tie each bamboo joint)	joints	14
Bamboo mat walls	m ²	156
Wall plate 40x50mm well seasoned loha/garjan kath	m	48
Chalkboard 1800x1200mm	no.	4
Roofing		
0.45mm thick corrugated galvanized iron sheets (roof)	m ²	147.30
150x75mm loha or garjan kath roof truss (7300mm)	no.	10

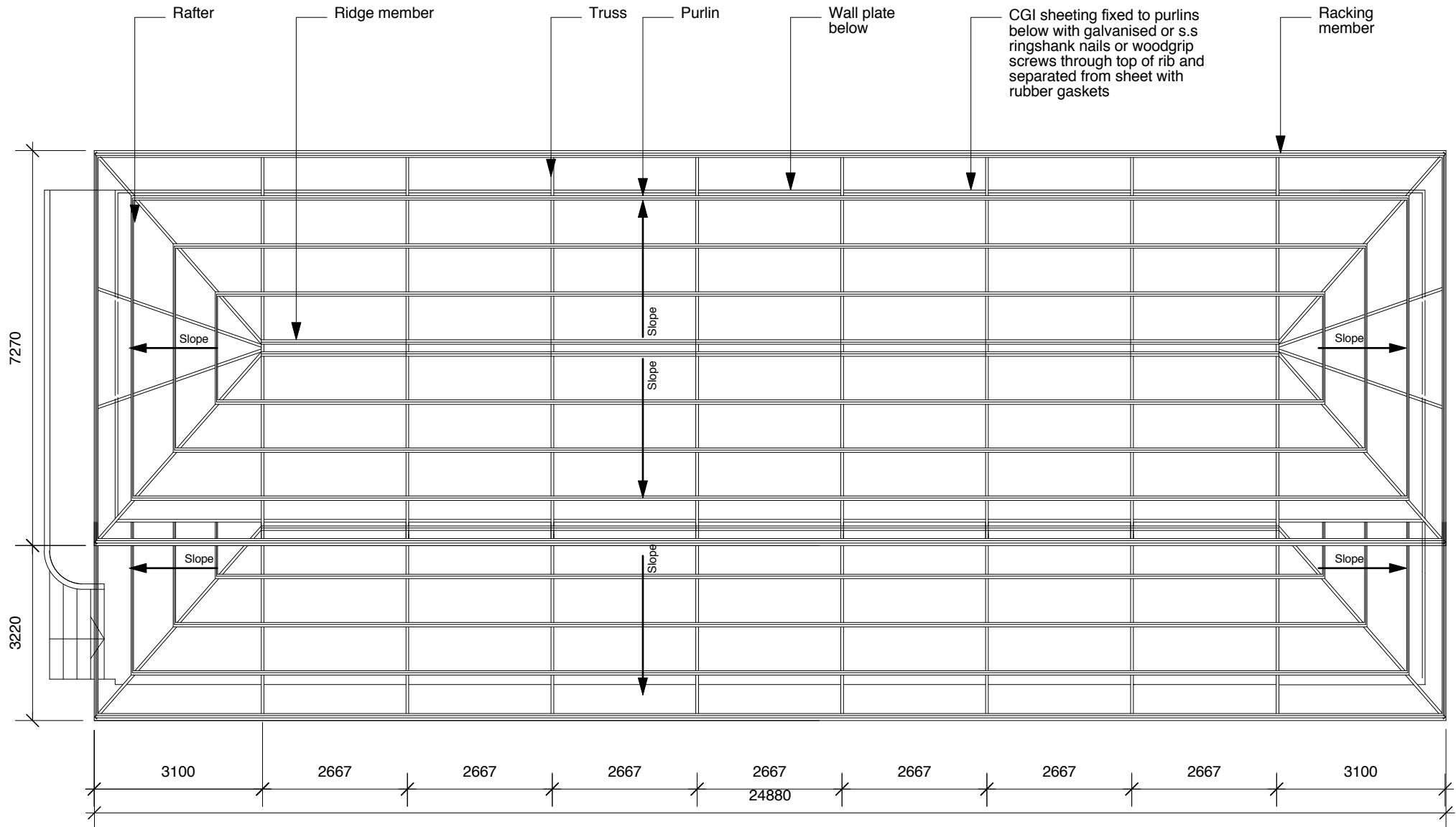
150x75mm loha or garjan kath ridge member (10,000mm)	no.	2
150x75mm loha or garjan kath ridge member (3200mm)	no.	2
150x75mm loha or garjan kath racking member (4200mm)	no.	8
150x75mm loha or garjan kath racking member (2400mm)	no.	8
150x75mm loha or garjan kath purlin (1050mm)	no.	2
150x75mm loha or garjan kath purlin (11500mm)	no.	2
150x75mm loha or garjan kath purlin (12500mm)	no.	2
150x75mm loha or garjan kath purlin (13300mm)	no.	2
150x75mm loha or garjan kath purlin (5200mm)	no.	2
150x75mm loha or garjan kath purlin (6200mm)	no.	2
150x75mm loha or garjan kath purlin (7000mm)	no.	2
150x75mm loha or garjan kath purlin (7200mm)	no.	4
150x75mm loha or garjan kath purlin (5600mm)	no.	4
150x75mm loha or garjan kath purlin (3750mm)	no.	4
150x75mm loha or garjan kath purlin (2000mm)	no.	4
Accessories		
Chalkboards (1800x1200mm)	no.	3
*L.S. - fixed price total work cost		



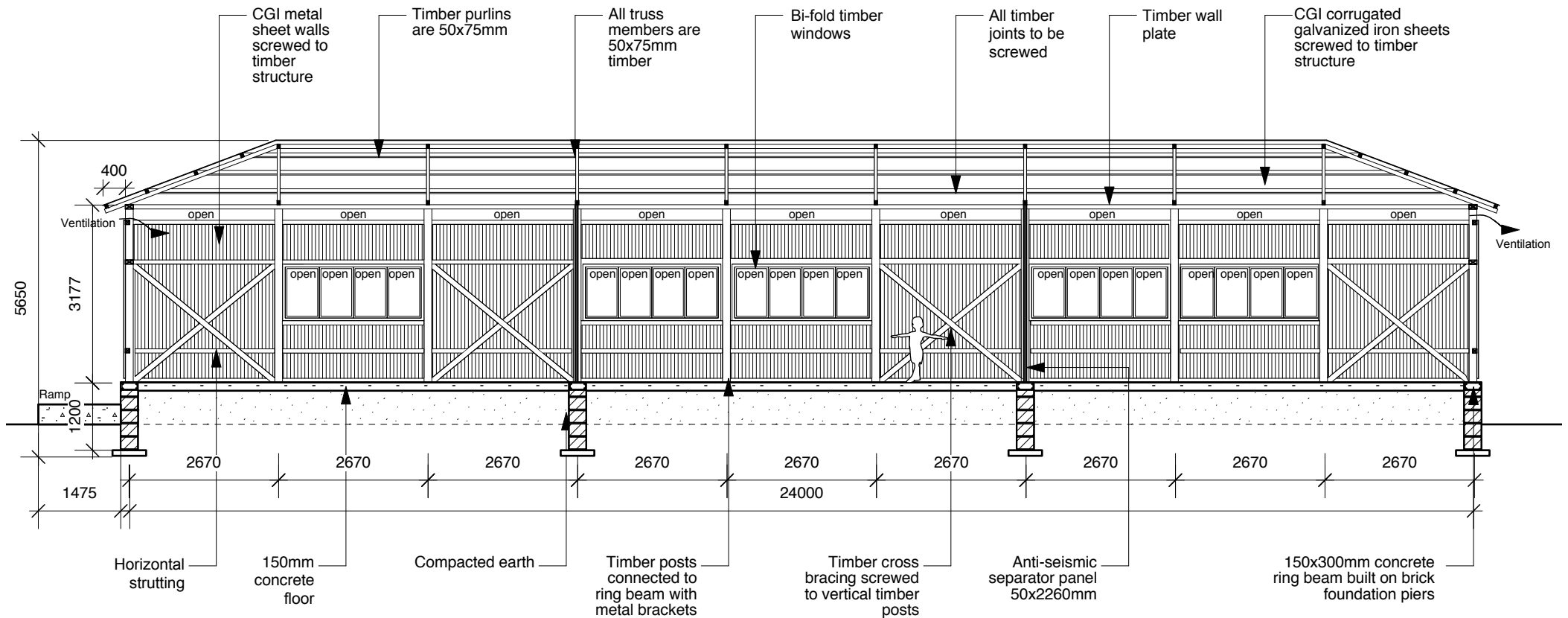
Note: drawing not to scale; for illustrative purpose only



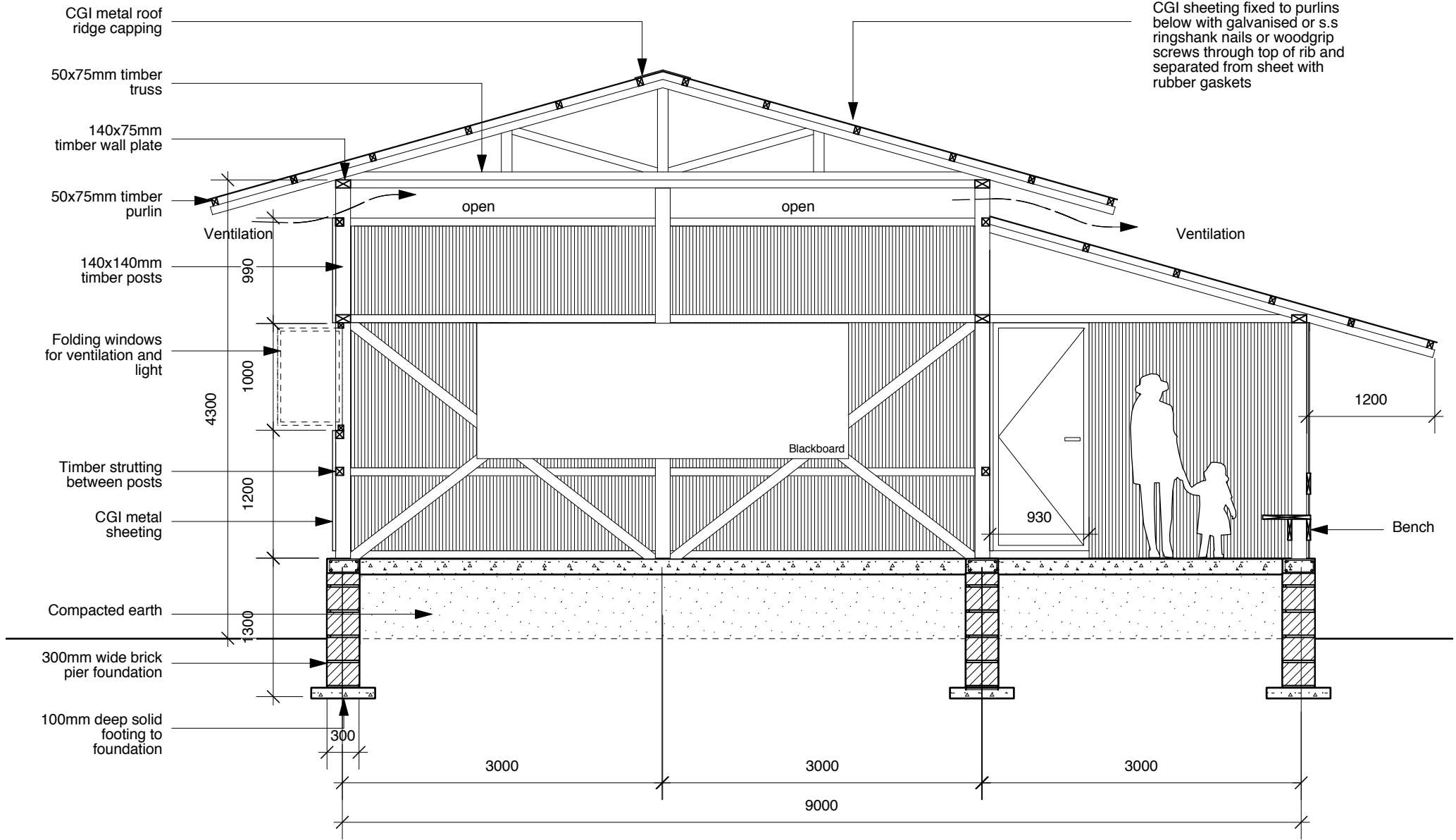
Scale 1:100



Scale 1:100



Scale 1:100



Scale 1:50

Quantities for 3 units, 48sqm each		
Element	Unit	Quantity
Excavation and Earthwork		
Mobilisation/Layout	L.S *	1
Excavate for foundations	m ³	40
Foundations		
150x300mm reinforced concrete ring beam	m ³	4
300mm wide, 1220mm deep brick pier foundation	m	108
100mm deep solid footing to foundation	m	108
Compacted earth	m ³	136
Floor		
150mm concrete floor	m ²	226
Walls		
140 x 140mm timber posts (3,180mm length)	no.	34
Metal brackets	no.	34
Timber cross bracing (3,300mm length)	no.	28
Horizontal strutting (24,000mm length)	no.	8
Horizontal strutting (6,170mm length)	no.	4
CGI Metal sheets	m ²	256
Anti-seismic separator panel (50x2260mm)	no.	1
140 x 75mm timber wall plate (24,000mm length)	no.	2
140 x 75mm timber wall plate (6,170mm length)	no.	2
Timber bench 2500x25x400mm	no.	4

Timbet bench supports 200x25x2000mm	no.	16
Openings		
BI fold timber windows (1000x600mm sections)	no.	16
Roofing		
0.45mm thick corrugated galvanized iron sheets	m ²	270
CGI metal roof ridge capping	m ²	20
Ridge member (18.7m)	no.	2
50x75x2000mm timber for trusses	no.	104
50x75x2000mm timber for purlins	no.	65
50x75x2000mm timber for rafters	no.	22
Accessories		
Chalkboards (1800x1200mm)	no.	3
*L.S. - fixed price total work cost		



Photo: UNICEF, China

External View of prefabricated transitional school

CHINA

2008 / Earthquake/ UNICEF + UNHCR

Agency:	UNICEF China in Collaboration with UNHCR
Location:	Wenchuan County, Sichuan Province
No. of users:	Total 5,000 children; classroom max. 50 children with the possibility of partitions to break the space into more classrooms
Anticipated lifespan:	8-10 years
Actual lifespan:	Not known
Facilities provided:	Classrooms, WASH facilities including latrines, hand wash points and drinking water
No. of facilities:	100 prefabricated classrooms

Construction time:	-
Main construction materials:	Sandwich panels, steel frames, CGI sheets
Material sources:	Imported to region from within China
Approx. project cost per unit:	-
Approx. material cost per unit:	-
Size of units:	Twin classroom layout: 12.9 X 5.6m, 72sqm
Size of construction team:	4 workmen with knowledge of the assembly procedure
Construction skill required:	Assembly knowledge needed
Who built the facilities:	Prefabrication by manufacturer, assembled by contractor
Site information:	Remote mountainous area with difficult access, subject to very severe winter conditions

Background

On 12 May 2008, a massive earthquake struck Sichuan Province, leaving 88,000 people dead or missing and 400,000 injured. It damaged or destroyed millions of homes, left five million people homeless and caused extensive damage to infrastructure, including schools, hospitals, roads and water systems. The earthquake hit children especially hard, damaging more than 12,000 schools. About 40% of schools in Sichuan were destroyed. The earthquake struck during the early afternoon when virtually every child in the province was in class.

Project Description

The project focused on one of the most severely affected counties located in a remote mountainous area that is subject to severe winters with heavy snowfall. Initial damage assessment found that schools in this and similar remote areas were not in the reconstruction plan of the Government in the near future. This would deprive the children of access to their education, further prolonging the disruption of their schooling and their lives' normality, which was already severely affected by the earthquake.

A prefabricated solution was chosen due to several reasons. Firstly, the severe winter weather conditions rendered the TLS in tents an impractical solution. In addition, many children expressed their preferences to prefabricated transitional learning spaces. The children felt safer in these structures, as many had seen their old school collapse during the earthquake and distrusted similarly constructed buildings. Finally, the prefabricated concept gave the option to be transferred to any future emergency situation, as it has a long lifespan and could be used as health centres, child friendly spaces and other social services

The project included the provision of WASH facilities including gender-separated latrines, hand wash points and drinking water. Other UNICEF projects worked to improve the sanitation and water supply system to these remote rural communities.

TLS Summary

The design of the prefabricated TLS was made jointly by UNICEF and UNHCR. The key design parameters for the structures were its long lifespan of eight to ten years, by which time alternative and more permanent school structures will have been built. Furthermore, to provide children a psychological feeling of safety and the structure's capacity of withstanding severe weather, like wind, rain and snow, and conforming to at least minimum safety standards to withstand future earthquakes.

Each TLS had the capacity for 50 children with a twin classroom arrangement with the size of 72sqm, 12.9m X 5.6m. This larger room size allowed possible partitioning to split the space into two classrooms.

The main structure is a lightweight prefabricated steel frame with cross bracing to increase its earthquake resistance. Insulated steel clad sandwich panels with windows are fixed in between the steel posts. The roof is constructed from insulated corrugated galvanised iron sheets. The prefabricated school was procured from the manufacturer to a prepared site where it was erected in situ.

Active market research was done to identify potential manufacturers. A third party inspection company inspected the manufacturing companies before procurement was initiated to assess the quality of the manufactured structures.

DRR

The main aspects to be considered is the safe location of TLS in earthquake zones; sites on slopes require leveling and retaining walls to prevent landslides. Structurally safe construction is essential, as aftershocks are common and TLS may be in use longer than anticipated before permanent school are completed.

Maintenance

The monitoring of the installation and use of the prefab schools was conducted.

Challenges

- The initial cost of the prefab schools is expensive compared to school tents.
- Transportation to very remote areas with very poor road access was difficult and costly

Improvements

- UNICEF is working in the development of a package for electrification of the schools using solar power in these remote areas
- Alternative means of escape, access to the classroom at opposite sides to allow fast escape in case of an emergency
- Addition of a central partition that subdivides space
- Additional windows for increased ventilation and natural light



Photo: UNICEF, China

Assembly process of prefabricated school in Sichuan province



Photo: UNICEF, China

External view of prefabricated school in Sichuan province



Assembly process of prefabricated classroom



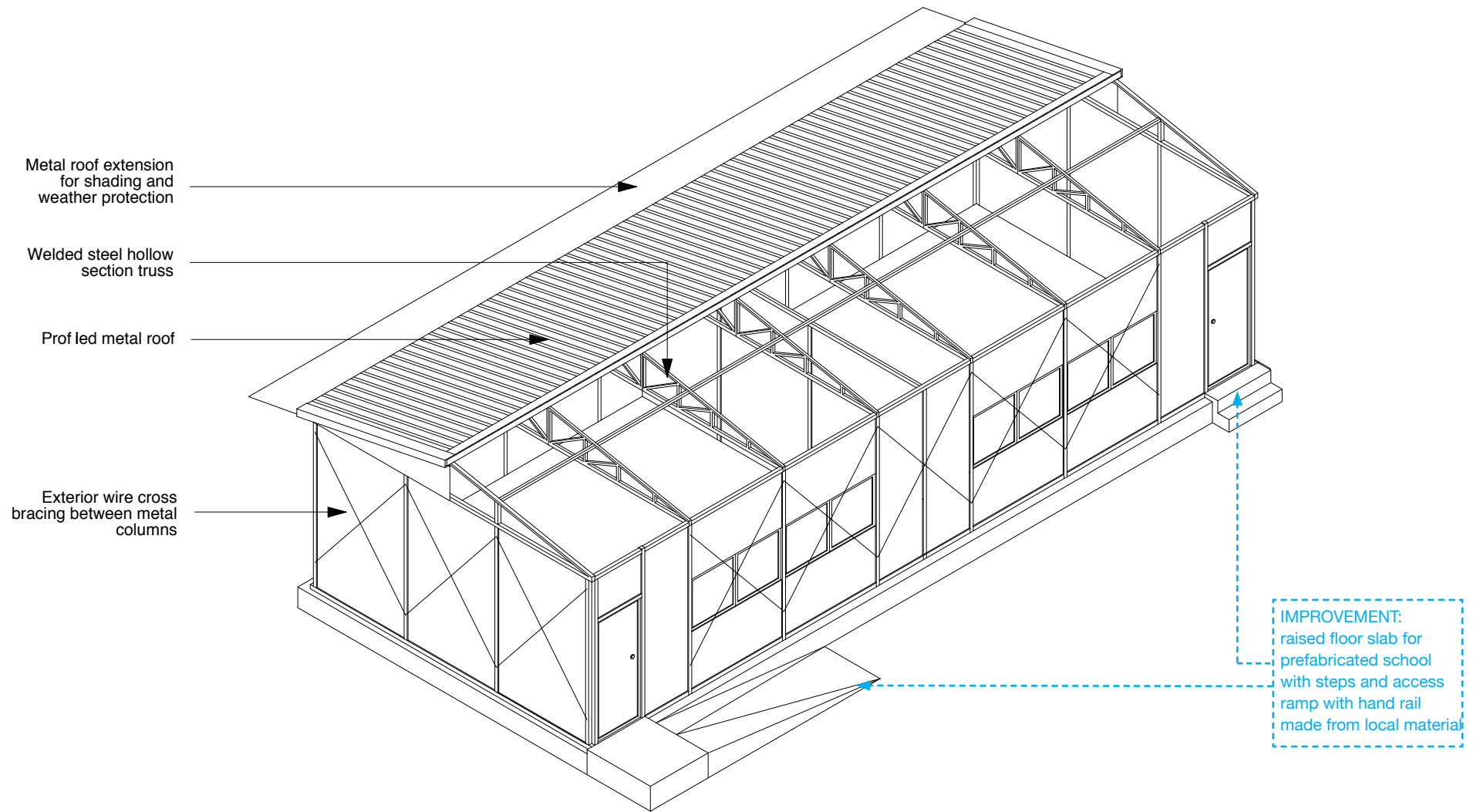
Photo: UNICEF, China website

Children outside prefabricated school

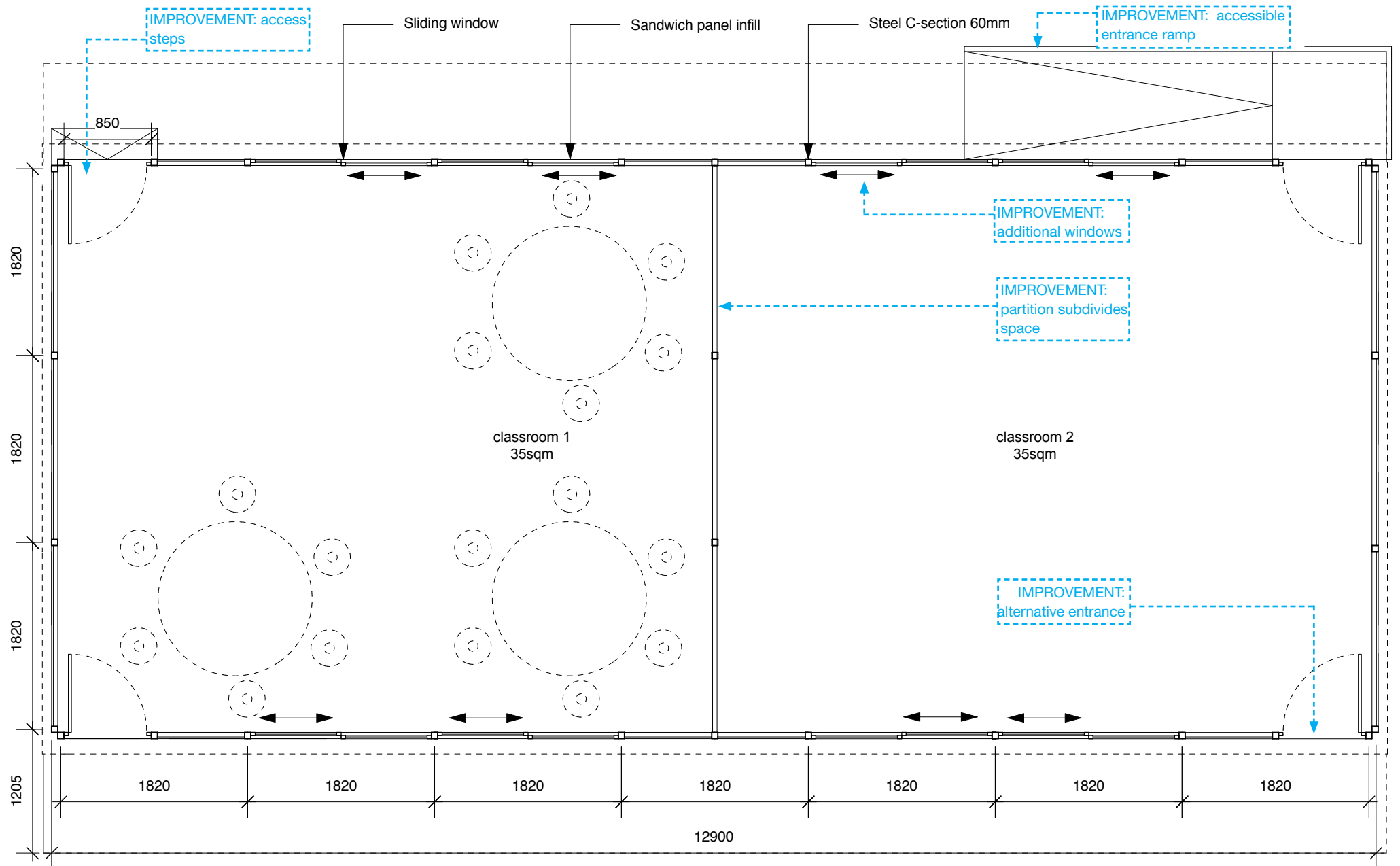


Photo: UNICEF, China website

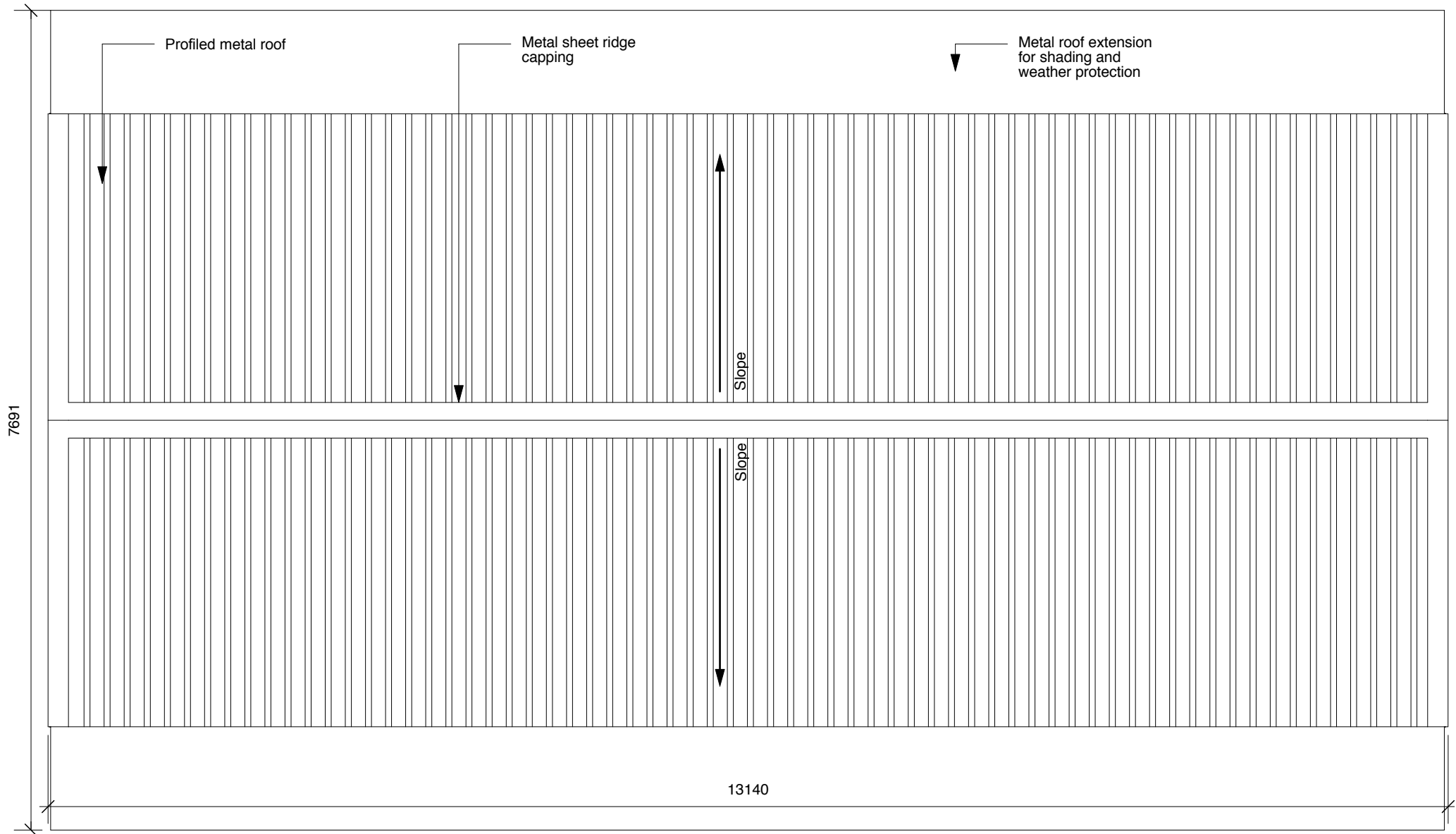
Hand wash next to latrines



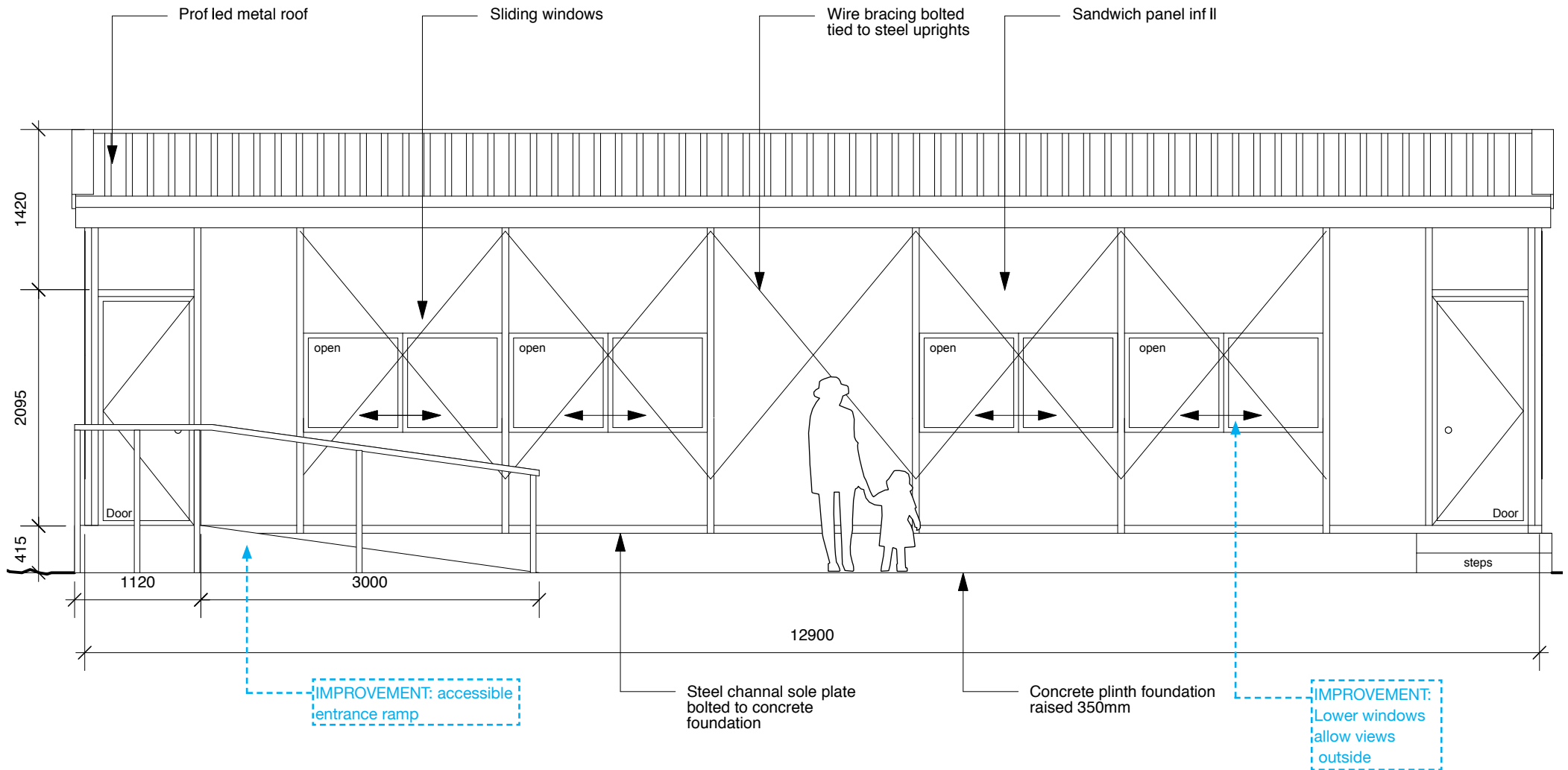
Note: drawing not to scale, for illustrative purpose only



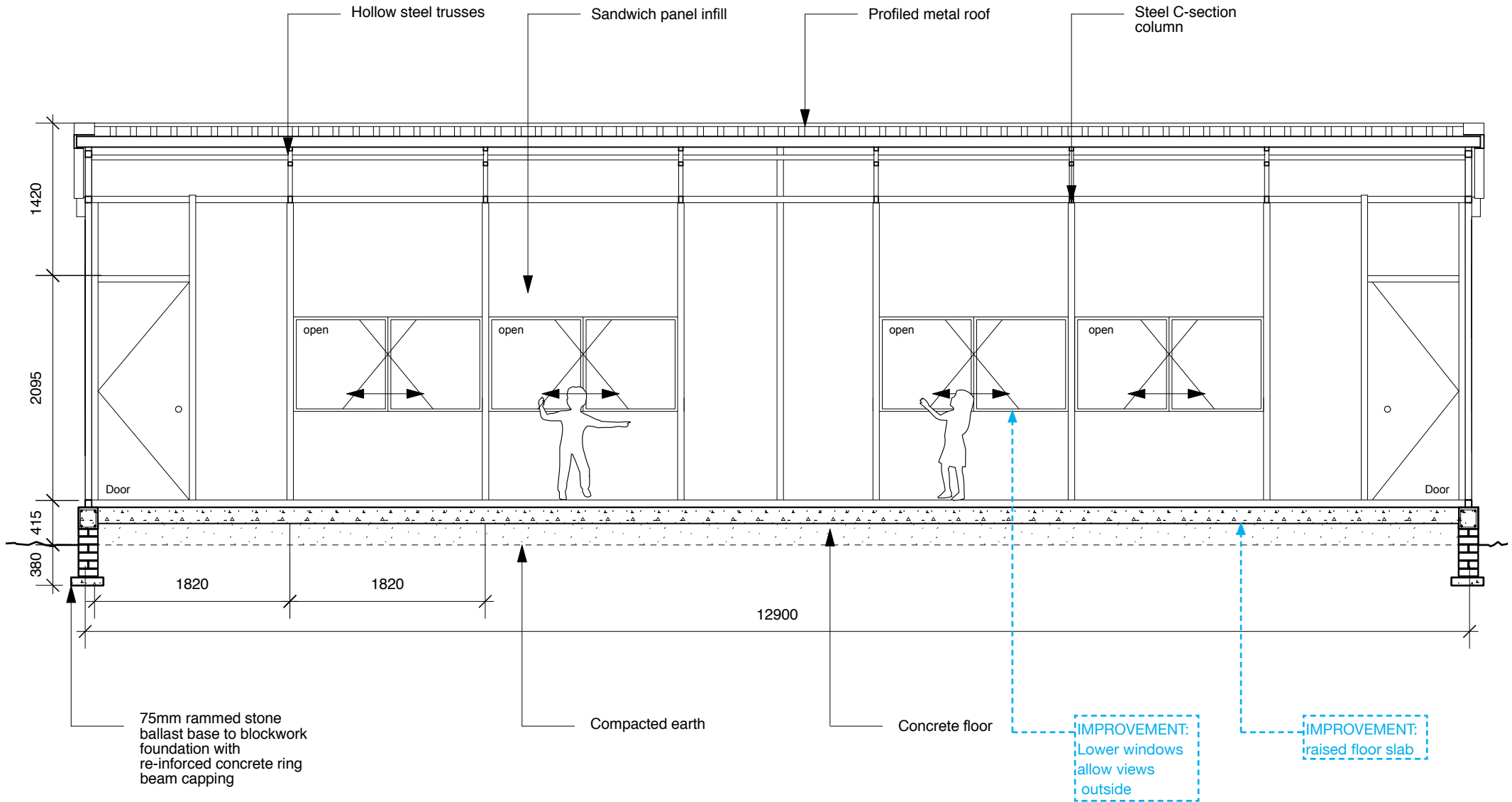
Scale 1:50



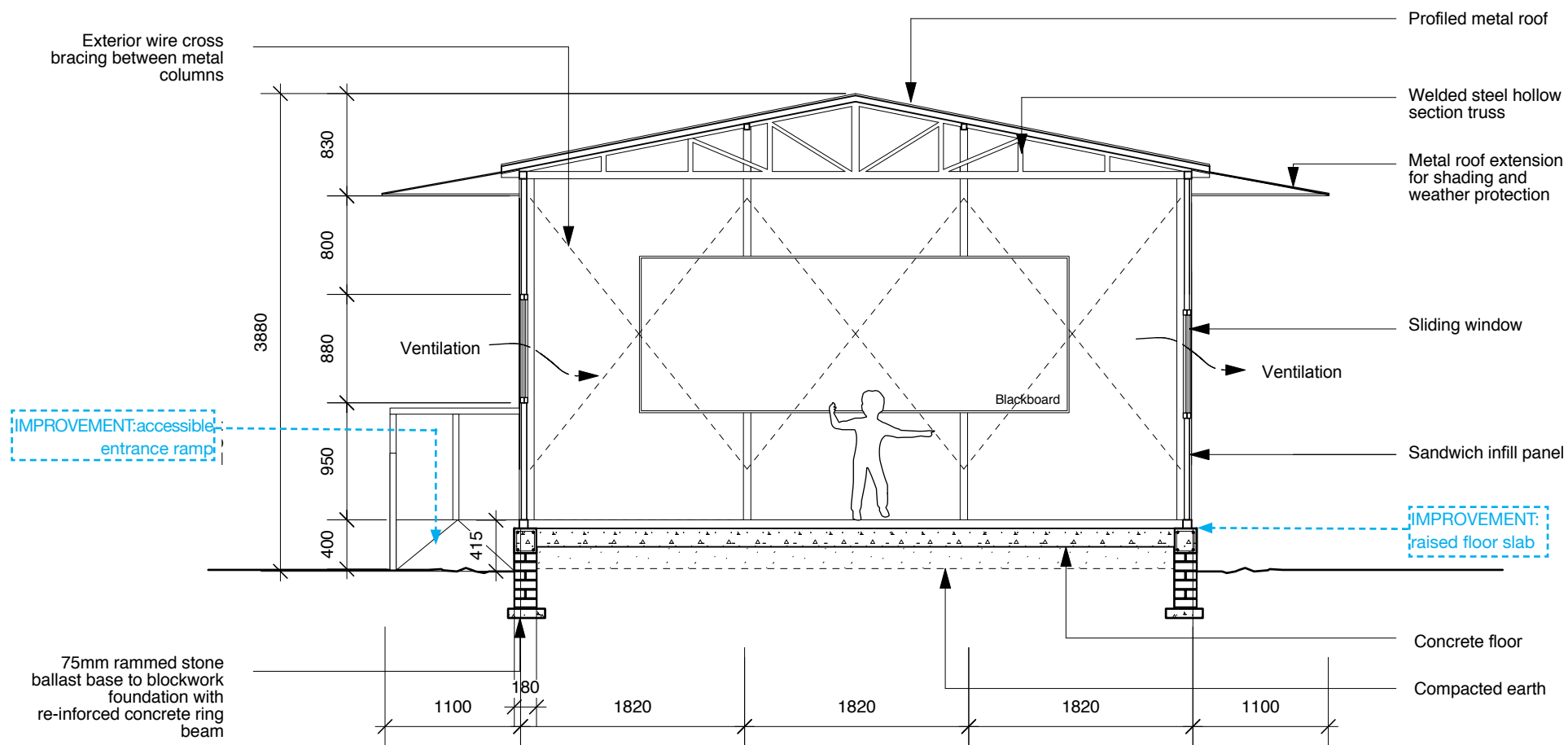
Scale 1:50



Scale 1:50



Scale 1:50



Scale 1:50

Quantities for 2 units, 35sqm each

Elements	Unit	Quantity
Foundations		
Concrete	m ³	15
Walls		
Steel C-Section Column (2,800mm)	no.	44
Steel C-Section Column (3,200mm)	no.	8
Steel Square-Section bar (1,760mm)	no.	36
Steel Square-Section bar (1,700mm)	no.	4
Steel Square-Section bar (850mm)	no.	4
Door (2,030x850mm)	no.	4
Sliding Window (1,760x880mm)	no.	8
Sandwich wall panel (940x1,760mm)	no.	6
Sandwich wall panel (950x1,760mm)	no.	6
Sandwich wall panel (850x2800mm)	no.	4
Sandwich wall panel (850x680mm)	no.	4
Sandwich wall panel (2,800x1,700mm)	no.	3
Sandwich wall panel (2,800x1,730mm)	no.	6
Bracing steel (with post bracket) (2,850mm)	no.	32
Roof		
Welded steel hollow section truss	no.	6
Metal sheet ridge capping (13,000mm)	no.	1
Profiled metal roof (13,000x2,900mm)	no.	2
Metal roof extension (13,000x1,000mm)	no.	2

Field Notes:

This is space for individual field notes, documentations and observations.



Phase 2, external view of classrooms and school grounds

Photo: UNICEF, Haiti

HAITI

2010 / Earthquake / UNICEF

Agency:	UNICEF / Haiti Office
Location:	Countrywide coverage in earthquake-affected areas (phase 1/2)
No. of users:	Phase 1: 325,000 children/6,500 staff, Phase 2: 120,000 children/1,400 staff, 50 children per classroom (double shift)
Anticipated lifespan:	Phase 1: 6 months, Phase 2: 15 years, (Phase 3: 40 years)
Actual lifespan:	Phase 1: canvas replacing of tent approximately 2 years, Phase 2: 25-30 years
Facilities provided:	Phase 1: Classrooms (tents), administration offices, chemical latrine, Phase 2: classrooms (TLS), administration offices, gender separated sanitation units (toilets), hand washing+drinking water facilities, security fence

No. of facilities:	Phase 1: 2000 tents (600 schools with 4 classrooms (average) and+1 administrative office Phase 2: 1200 TLS (200 schools with 6 classrooms (average) and+1 administrative office, sanitation block (8 units)
Construction time:	Phase 1: 2-3 days; Phase 2: 21-60 days, depending on accessibility/difficulties of sites
Main construction materials:	Phase 1: Imported tents, Phase 2: Steel structure of imported tents, cement, sand, gravel, steel reinforcement bars, concrete blocks or stone, fibre cement sheets for partitioning, insulated galvanised sheets, paint
Material sources:	Phase 2: Locally sourced, except steel structure of tents, fibre cement sheets for partitioning, insulated galvanised sheets for the roof
Approx. project cost per unit:	Phase 1: 3,000 USD (tent including transportation and installation) Phase 2: 175,000 USD per school including learning spaces, administrative offices, sanitation blocks, perimeter fencing and supplementary works
Approx. material cost per unit:	Phase 1: 2,200 USD for each tent, Phase 2: 96,250 USD per school (materials+transportation 55% of the total cost of the school)
Size of units:	Phase 1: 42/72sqm, Phase 2: TLS 42sqm, admin office 30sqm
Size of construction team:	Phase 1: 11(supervisor with 10 unskilled workers), Phase 2: 30 people (10 skilled workers and 20 unskilled)
Construction skill required:	Phase 2: Concrete + masonry + steel works, plastering, sanitary works
Who built the facilities:	Phase 1: Community ("Cash for Work"), Phase 2: Local contractors + Community for demolishing/preparing the site ("Cash for Work")
Site information:	Most sites on slopes required grading/levelling, land ownership by Ministry of Education(public schools), land ownership by school (private ones), 5 schools located within the Red Zone (high risk security zone) Port-au-Prince

Background

In 2010 an earthquake of magnitude 7.0 struck near Port-au-Prince, Haiti's capital, causing dramatic destruction. An estimated 3.5 million¹ people were directly affected by the earthquake. Over 300,000 were killed, a further 300,000 injured, and 1.6 million forced into displacement².

3,978 schools were damaged³, more than 77% of the existing public education infrastructure⁴. The education cluster⁵ estimates that 90% of schools in Port-au-Prince and Leogane and 60% of the schools in the South and West departments have been partially damaged or destroyed, affecting some 500,000 children age 5-14 (48% girls). Even before the earthquake, 49% of children were not enrolled in school⁹.

Before the earthquake, access to improved drinking water (63% in 2008, up from 47% in 1990) was improving⁶, but was still not on track to meet the Millennium Development Goals (MDGs). Poor access to water was also the case in schools; even before the earthquake, 40% of schools didn't have access to drinking water. In respect to improved sanitation, infrastructure access was extremely low and had actually been decreasing (17% in 2008, down from 26% in 1990⁷), and 60% of schools didn't have a sanitation facility⁸. Combined with the lack of access to drinking water in schools, a total of over 873,000 children were being exposed to waterborne diseases at school.

After the earthquake, 94% of schools were found to lack a water, sanitation and hygiene (WASH) facility or proper hygiene promotion practice that is critical to ensure a healthy environment for students.

Project Description

UNICEF provides countrywide coverage of education interventions. The school construction project is divided into three phases, where Phase 1 and Phase 2 have focused on earthquake-affected areas with the distribution of 1422 tents to allow school to reopen. This phase is completed. Phase 2 is currently ongoing with the reconstruction of 200 schools; 1,200 classrooms, fit for 120,000 children, are constructed by transforming the original tent structures into semi-permanent learning spaces. Phase 3 is in its inception and aims to branch out into some of Haiti's most remote and rural areas that have no access to public education or any education facility at all¹⁰. These areas have also the poorest indicators in terms of education access. It is envisaged to construct new permanent schools in these rural areas where there are currently no public schools.

The main objective of the construction project is to upgrade the Phase 1 imported tent structures to semi-permanent learning spaces through the construction of windowsill height walls, GCI sheet roofing and concrete flooring.

The participation of the communities was represented in the site selection process, and in many instances they have been involved in "Cash for Work", which includes for Phase 1 tent erection and Phase 2 demolishing works and preparing working sites. In addition, some schools belong to the communities themselves and procedure for their involvement in maintenance processes. Phase 1 projects included the provision of classroom facilities, chemical latrines as well as administration office. Phase 2 included the provision of gender separated sanitation units, hand washing and drinking water facilities, as well as perimeter security fencing.

The Ministry of Education owns the land for public schools, while for private ones the school itself owns the land.

TLS Summary

The design concept is based on the upgrading of the original 42sqm tent structure provided in Phase 1. Phase 2 upgrades the primary tubular steel structure by cast concrete foundations, windowsill-high concrete columns with brick infill and insulated galvanised roof sheeting. The structure needs to respond to multiple hazards: earthquake, landslides, flooding and hurricane winds. To protect the structure from hurricane damage, the roof has a 30 degree slope, the CGI roof sheeting is bolted through the primary steel structure, the concrete block windowsill height walls are tied back to the main steel structure by a continuous concrete wall capping and reinforced concrete strip foundation/floor slab. The open areas allow for cross ventilation and natural light and are protected with tarpaulin from direct sunlight and strong winds.

In Phase 2 the schools have on average six Classrooms of 42sqm in various multiple classroom arrangements depending on the space available, existing vegetation and other site conditions. They are separated by fibre cement sheets partitions.

Most of the sites are located on slopes that required grading and levelling before the construction activities to protect the school grounds from landslides in case of flooding and earthquakes.

Operational maintenance procedure for the completed schools is under discussion and preparation with the Ministry of Education and the Directorate of School Buildings. Ways of involving communities are also being explored.

DRR

The main aspects to be considered is the safe location of TLS in earthquake zones; sites on slopes require leveling and retaining walls to prevent landslides. Structurally safe construction is essential. All Haiti case studies document hurricane resistant roof fixings and earthquake resistant wall to ground details.

Maintenance

Operational maintenance procedure prepared with Ministry of Education and Directorate of School Buildings. Ways of involving communities are also being explored.

Improvements

- Consideration to accessibility should be given in forms of ramps into the classroom
- Consideration for second access/escape in case of fire

¹ www.dec.org.uk/haiti-earthquake-facts-and-figures

²Source: 12th January 2011 statement by Prime Minister of Haiti at the Interim Haiti Reconstruction Commission (<http://www.reuters.com/article/idUSN1223196420110112>). Statistics unverified.

³Source: Children of Haiti: Three Months After the Earthquake, UNICEF, April 2010

⁴Source: Operational Plan (Final Draft), MENFP, December 2010

⁵co-lead by Save the Children

⁶Source: Joint Monitoring Programme for Water Supply and Sanitation, WHO/UNICEF, 2010

⁷Source: Ibid

⁸Source: MENFP, 2003

⁹Source: Ibid

¹⁰UNICEF has been sure to consider the different needs, challenges and opportunities in rural areas, for example lower access to water and sanitation (as a result, more innovative WASH schemes with rainwater harvesting will likely be a prominent feature of the schools constructed in Phase 3) and fewer constraints in terms of space (creating the opportunity to introduce school canteens as well as school gardens to supplement student meals, encourage school attendance and teach students/parents about the benefits of a balanced diet).



Phase 1, standard 42sqm imported tent



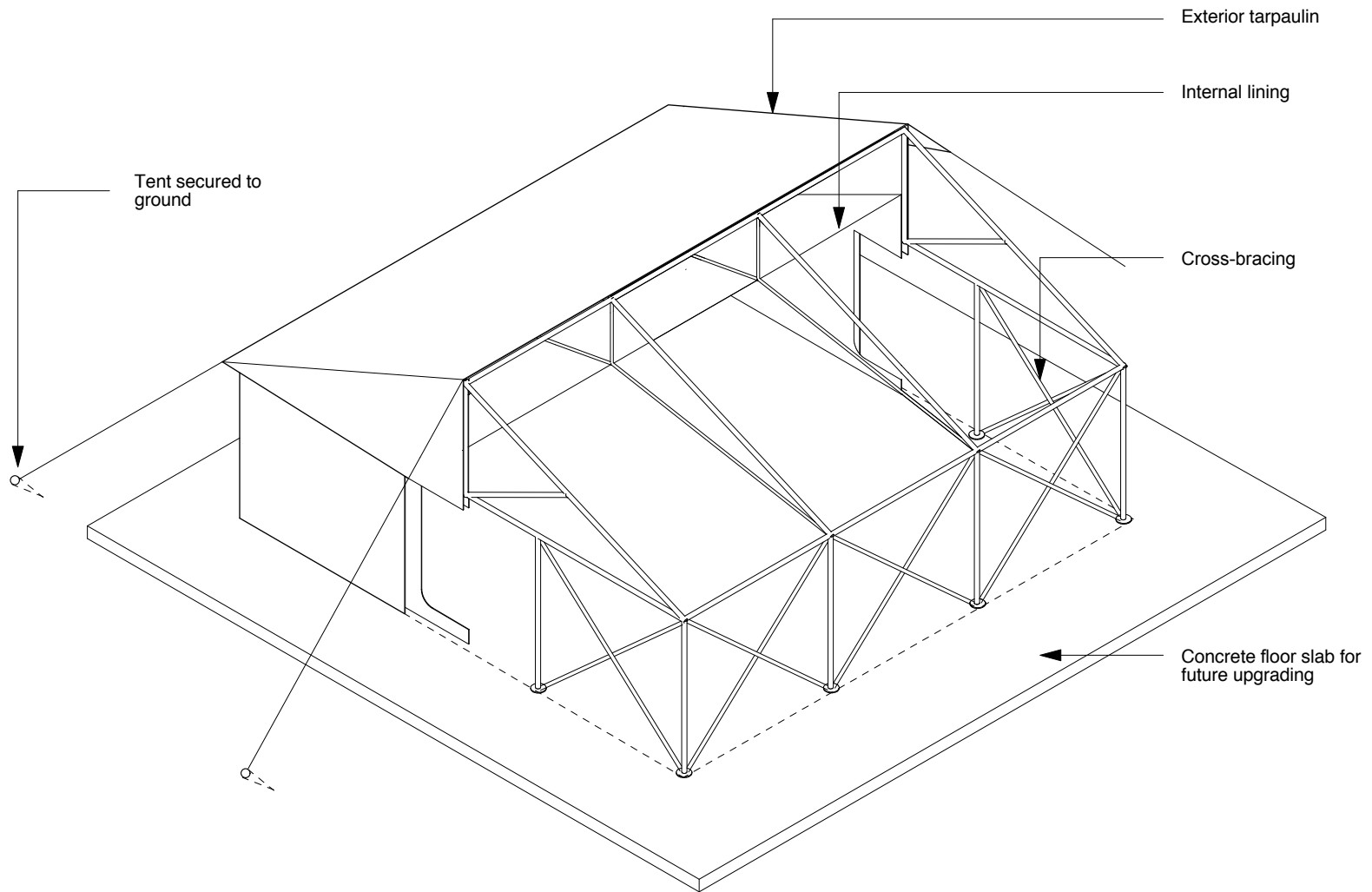
Phase 2, external view of upgraded tent structures



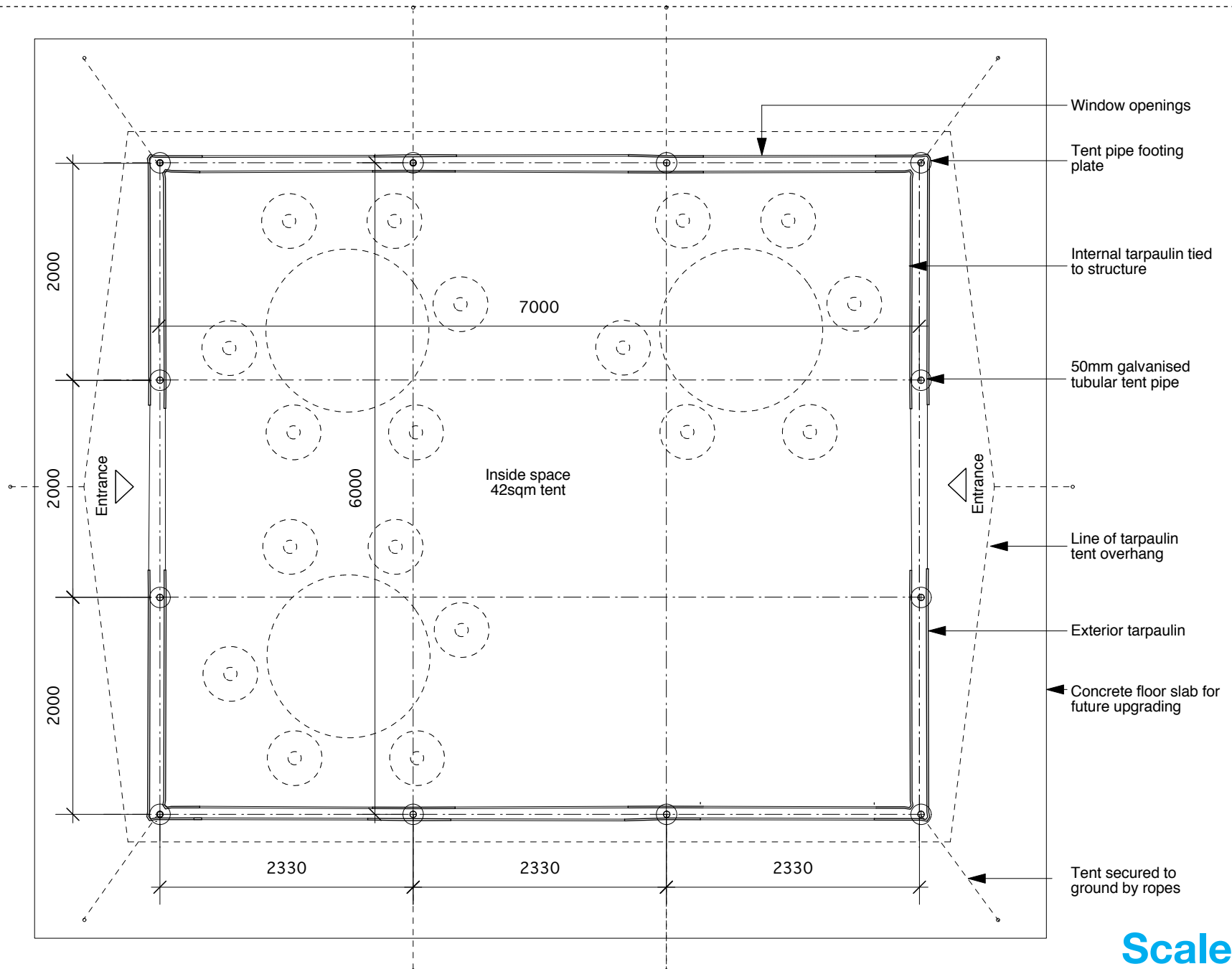
Phase 2, internal view of TLS, a child friendly learning environment



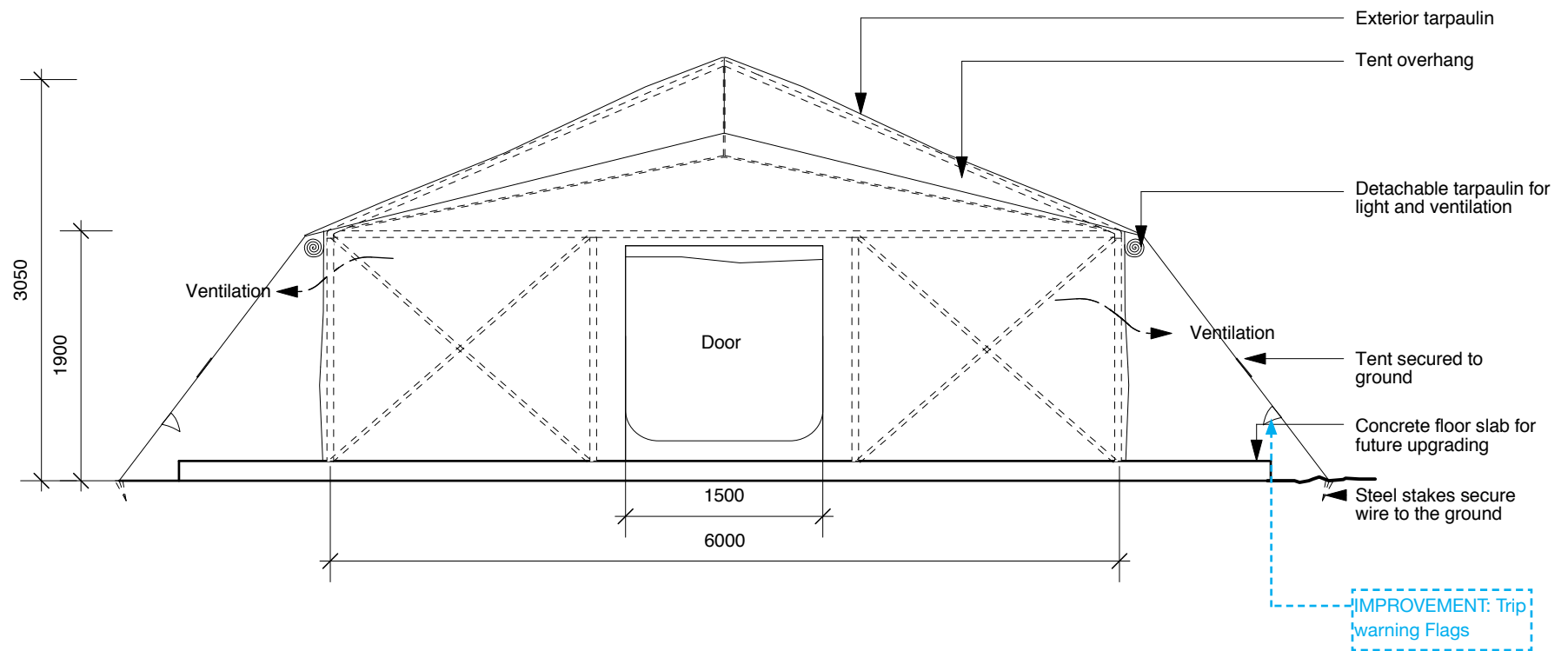
Phase 2, internal view of TLS, flexible spatial arrangement



Note: drawing not to scale, for illustrative purpose only



Scale 1:50



Scale 1:50



3-D Illustration: Gaston Becerra

Phase 2: Double classroom TLS



3-D Illustration: Gaston Becerra

Phase 2: Bird's eye illustration of double classroom spaces



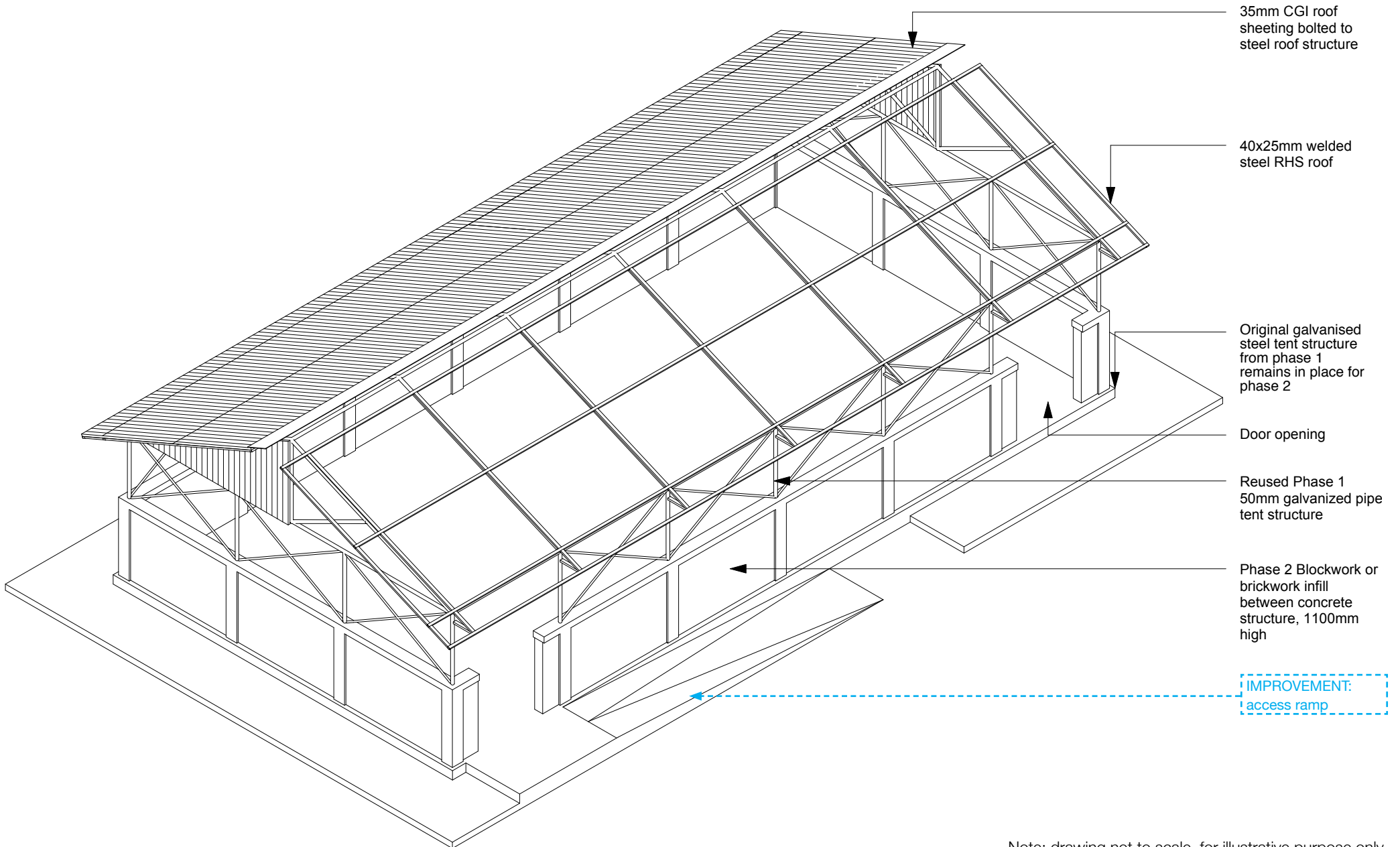
3-D Illustration: Gaston Becerra

Phase 2: Illustration of WASH facilities

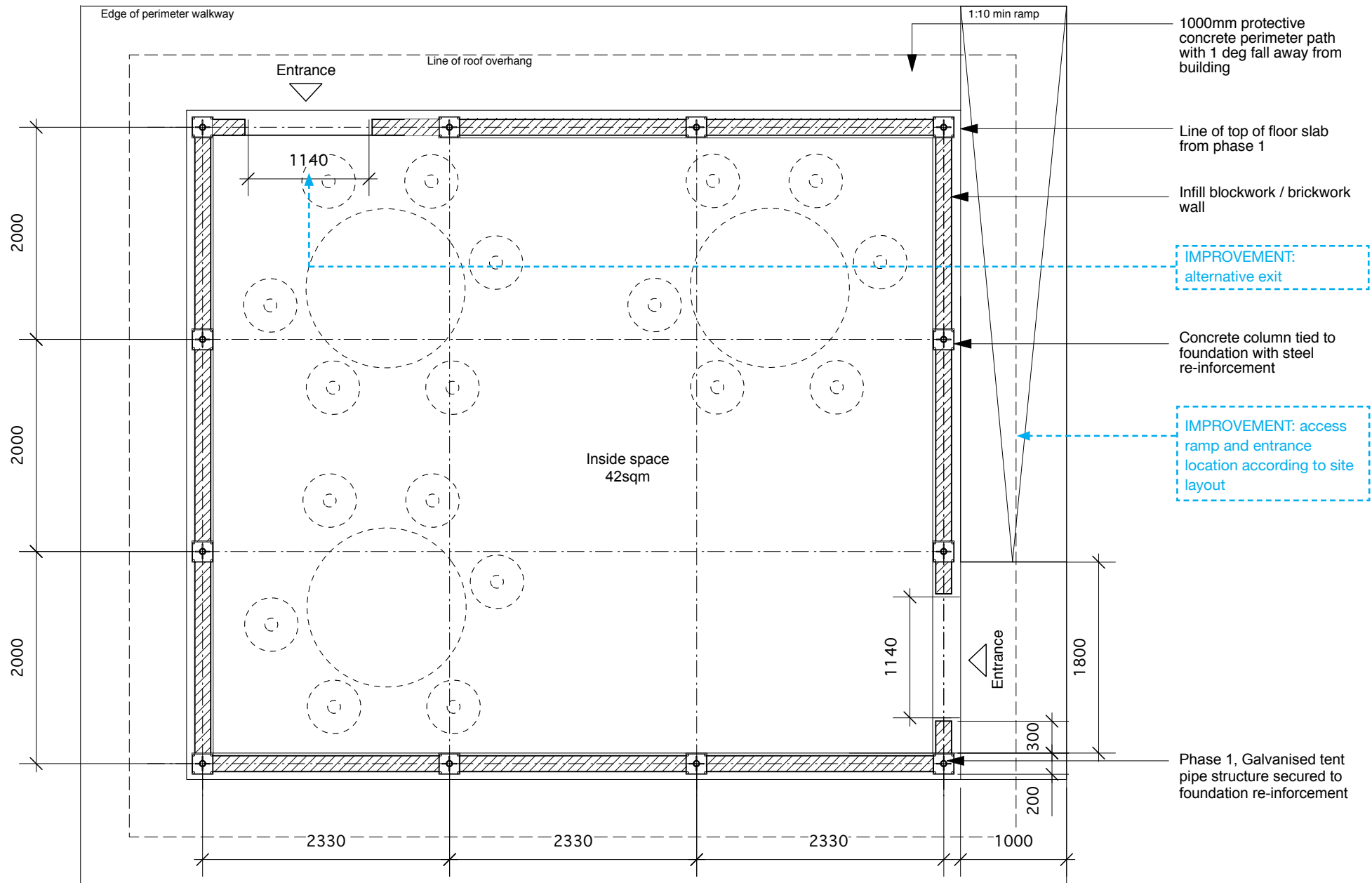


3-D Illustration: Gaston Becerra

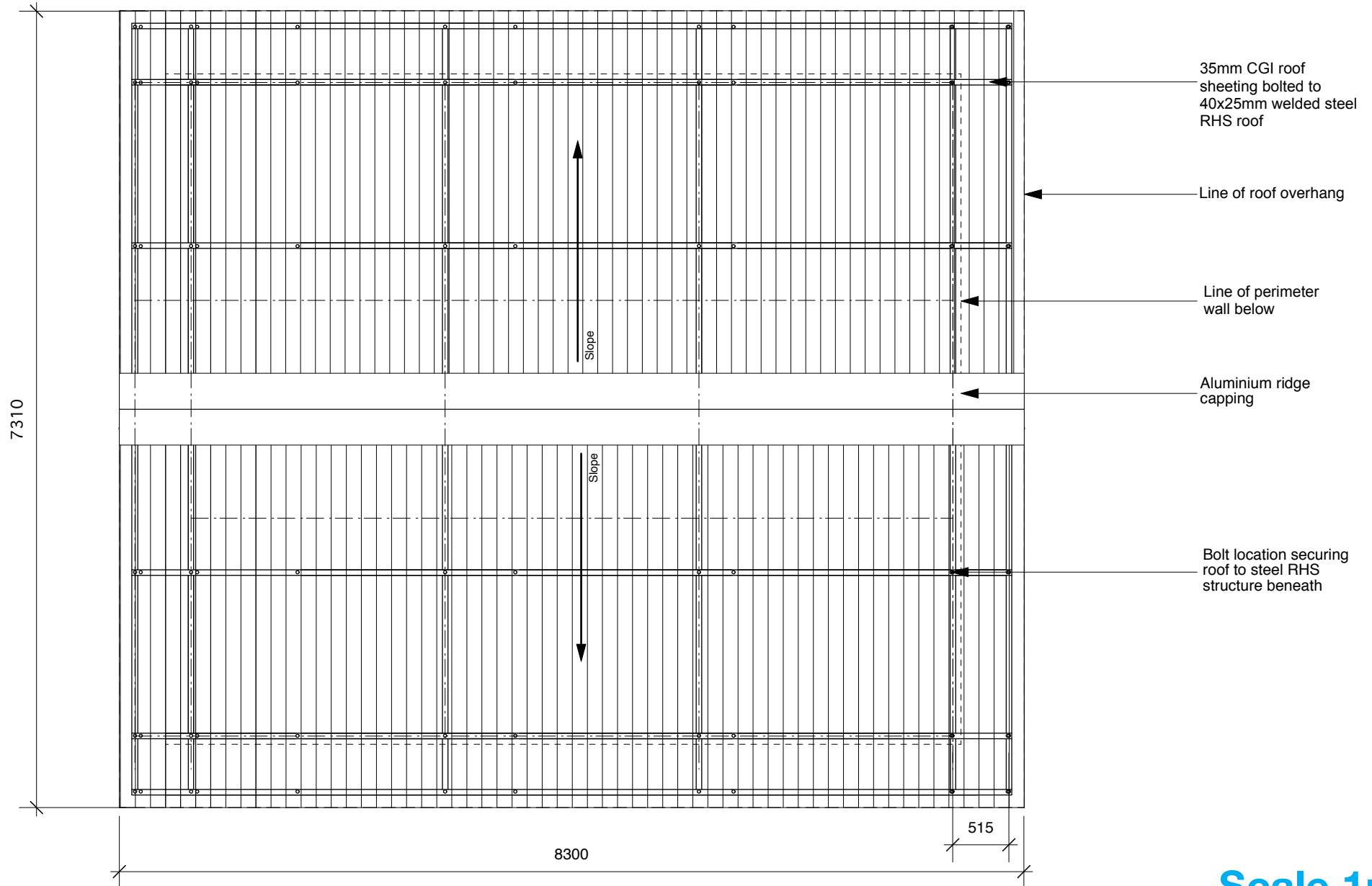
Phase 2: Illustration of gender separated toilet facilities



Note: drawing not to scale, for illustrative purpose only

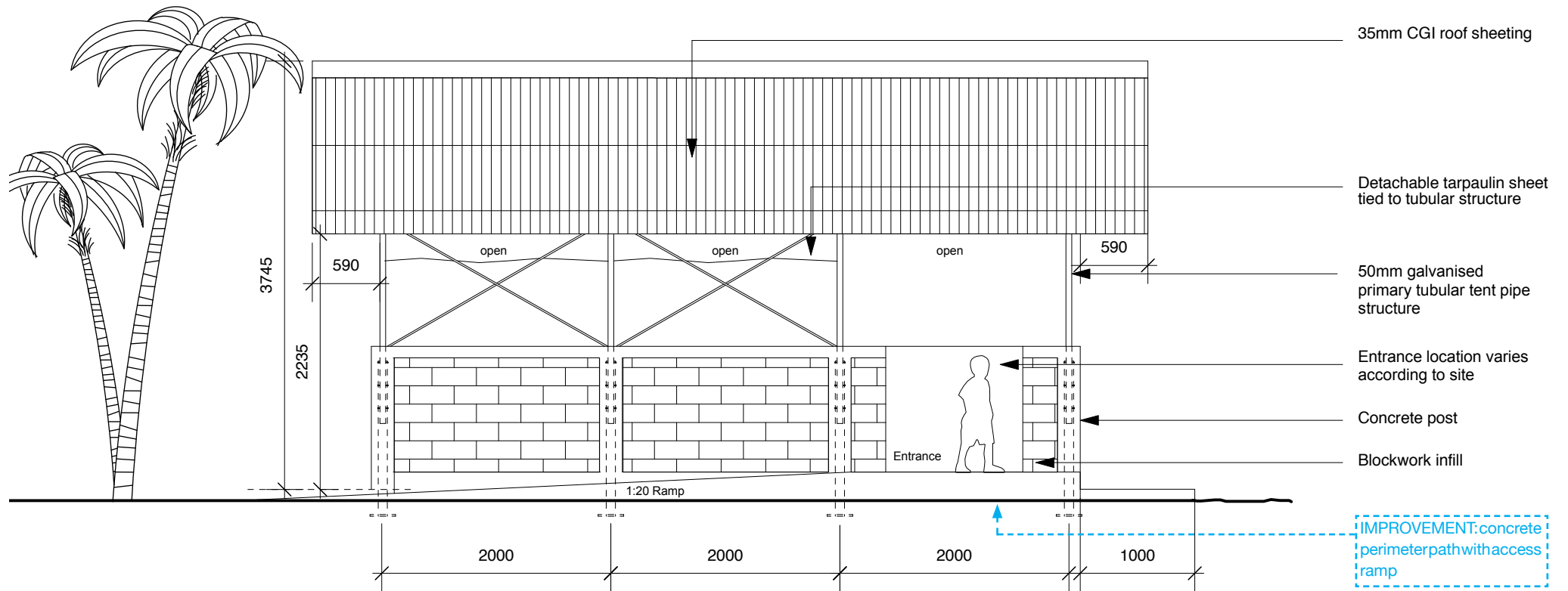


Scale 1:50



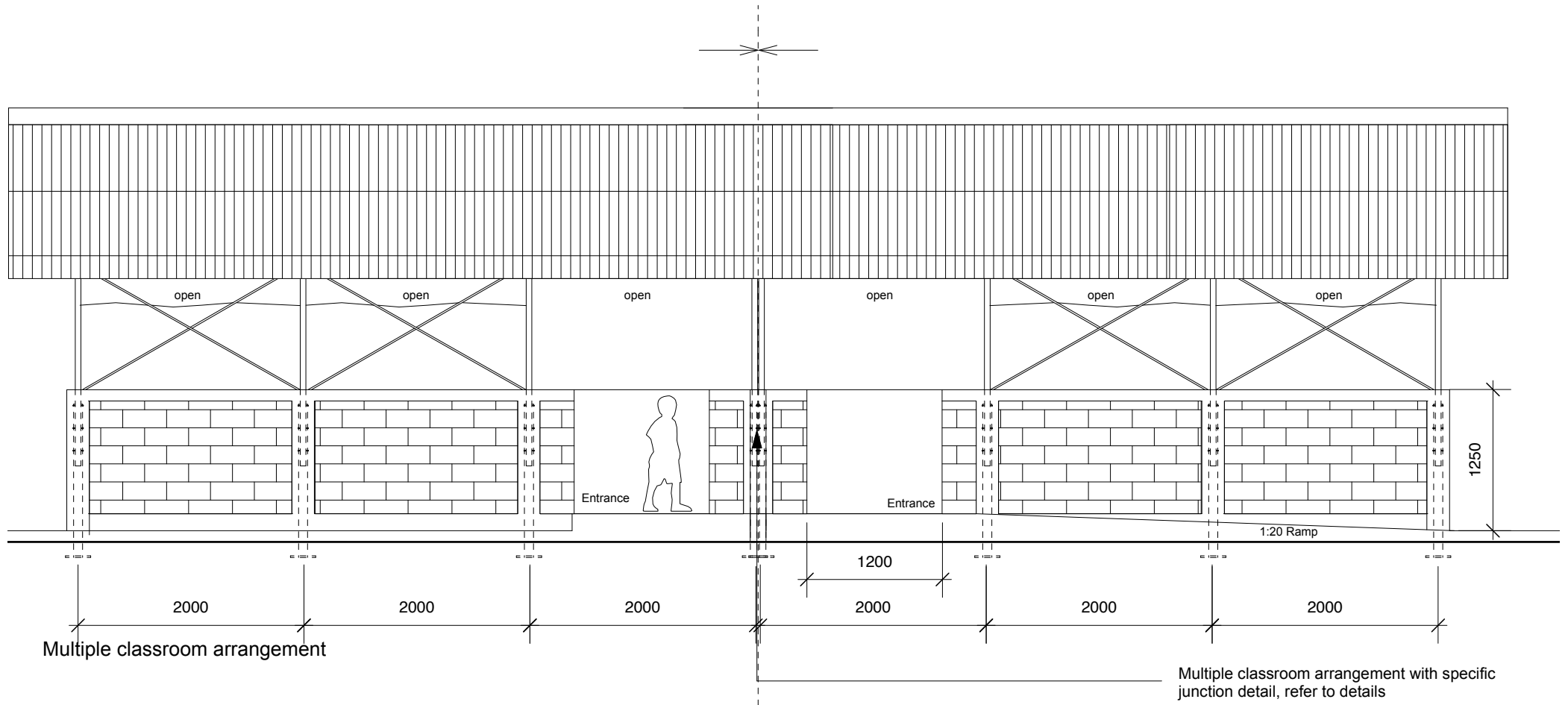
Scale 1:50

Type A : Single tent structure + classroom

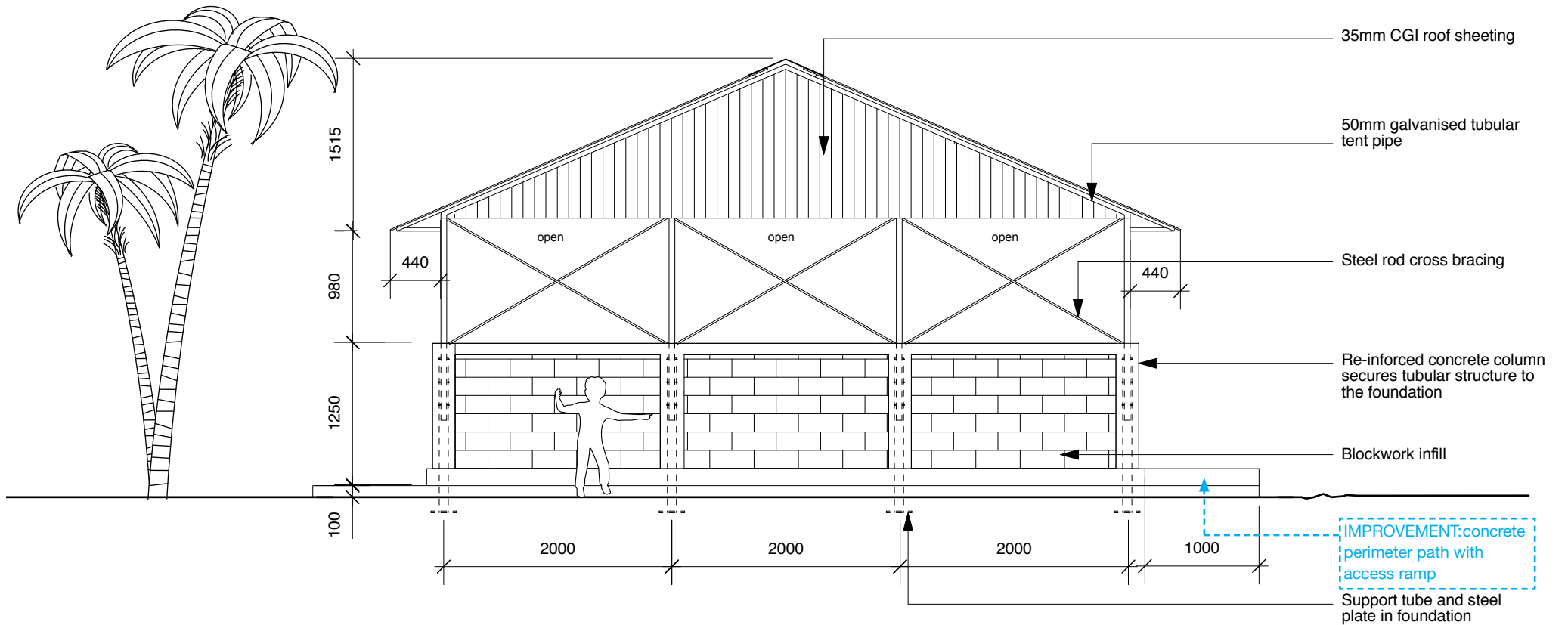


Single classroom arrangement

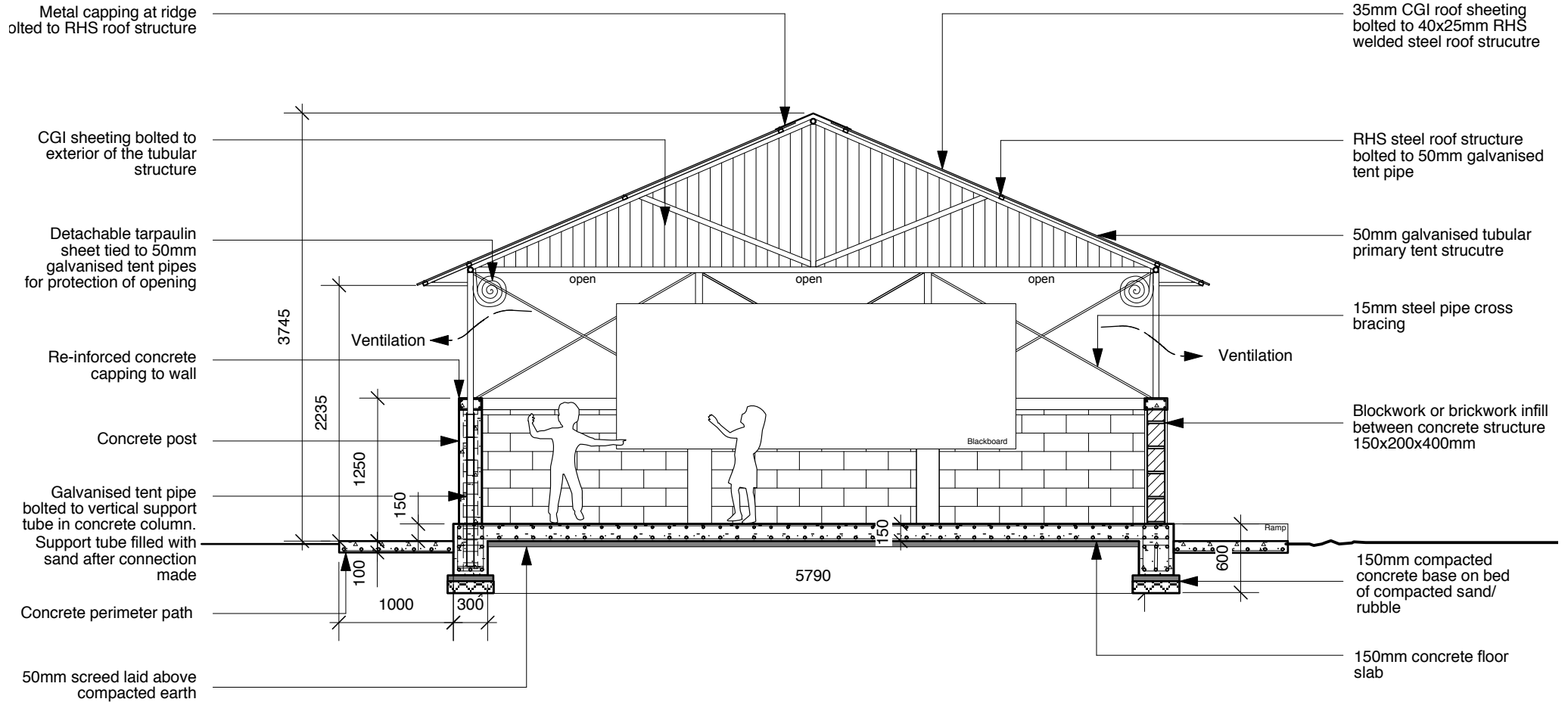
Scale 1:50



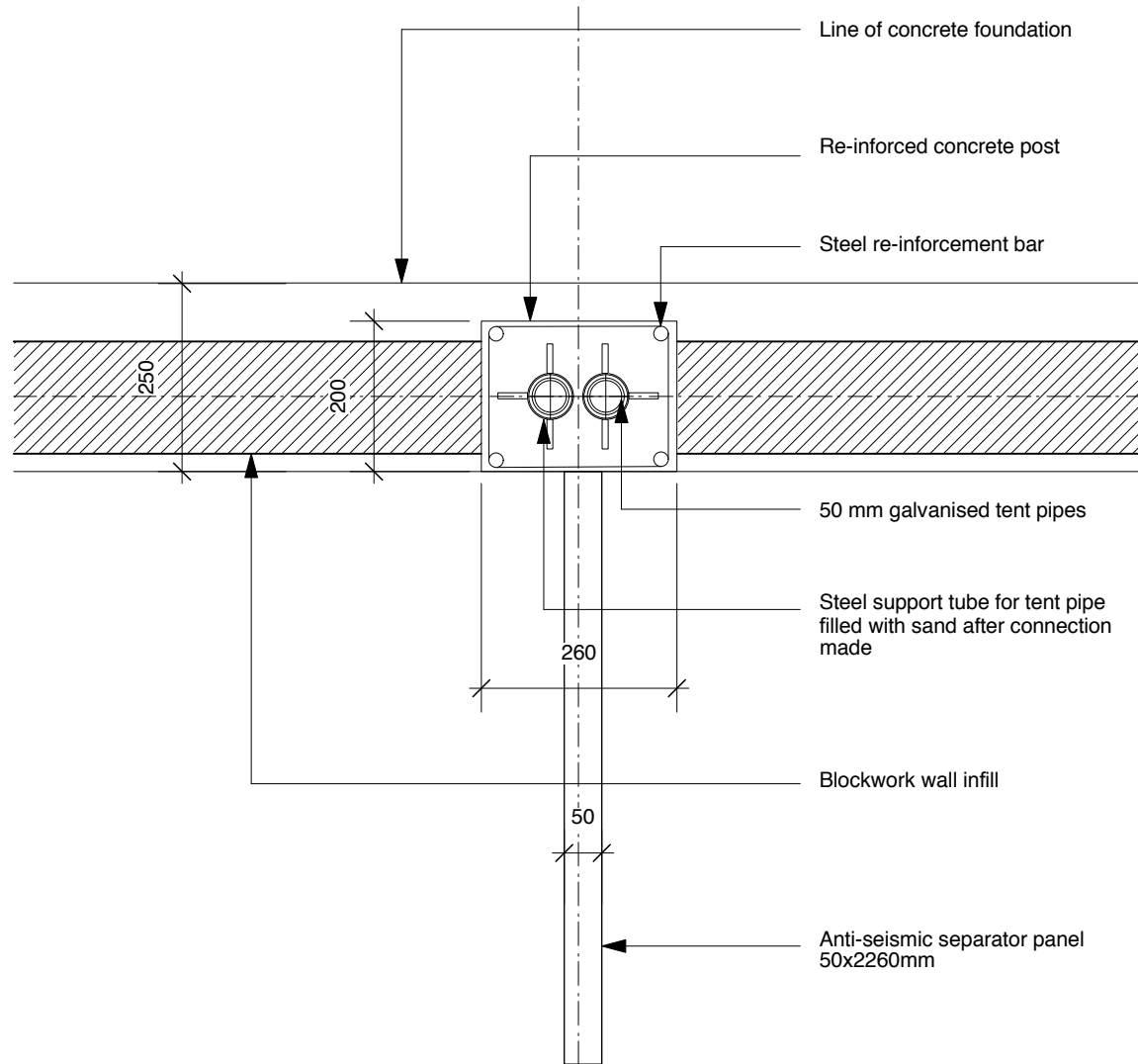
Scale 1:50



Scale 1:50



Scale 1:50



Scale 1:5

Quantities for a school 320sqm

Element	Unit	Quantity
---------	------	----------

Mobilisation / Site preparation

Transportation of materials, equipment and personnel

Clearing and grubbing of land

Transportation of debris to site selected jointly with the Engineer

Security measures (guards and temporary fence)

Establish lines and levels required of excavation m² 316

Establish location for foundations and structures

Establish reference point

* School 1 was set up on existing foundation

Excavation

Cleaning of land by hand or with machine m³ 29

Temporary support propping may be necessary

Channel excavation

Perimeter Foundation m² 29**Masonry wall in rocks and blocks**

Compacting floor

Circulation space around school m² 142

Masonry perimeter

Circulation space around school m³ 166

Compacting ground

Circulation space around school m² 383

Concrete

Concrete slab 0.20m thick, 350 kg/cm² m³ 63Concrete Slab 0.10m thick m³ 6Concrete Slab for pedestals m³ 3**Floor for school** m² **383****Masonry**Masonry blocks for elevation (0.15x0.20x0.40) m² 145Mortar cement 300 kg per m³

Re-pointing of indoor and outdoor U 7

Re-enforcement of tent

Galvanized steel pipes 50mm m 84

Aluminium sheet, 0.35mm thick natural colour m² 405

915mm wide insulation (aluminium colour)

Bracing of the roof (steel 12mm x 762mm)

Profile 25mm x 50mm battens and rails, painted aluminium colour ml 716

Labor to weld tubes onto existing tent structure ml 301

Privacy screenFibre cement sheet thickness 12mm on timber structure treated 50mm x 100mm m² 68**Painting**

On plywood as recommended by manufacturer U 6

On masonry wall m² 373

Outdoor installation

Construction of circulation space m² 150

External staircases

Construction of external staircase m² 12



Photo: Jack Ryan

External view of timber double classroom for Fleur de Chou school

HAITI

2010 / Earthquake / Plan International

Agency:	Plan International
Location:	Croix-des-Bouquets, Jacmel,
No. of users:	7,600 students and 152 teachers, approximately 50 students per classroom. Some schools used double shifting, likely student numbers higher
Anticipated lifespan:	20-30 years with proper maintenance
Actual lifespan:	Not known yet
Facilities provided:	Semi-permanent classrooms in twin module, WASH facilities including gender separated latrines, a hand-washing station, drinking water point, external play space, perimeter fence (existing as part of school grounds)

No. of facilities:	Total 152 classrooms
Construction time:	8 workmen, 10 days to built the timber frame, 5 days for concrete base. Total of 15 days per double classroom
Main construction materials:	Reinforced concrete, timber structure, coated exterior grade plywood cladding, corrugated asphalt roofing, steel gutters and downspouts, rain collection barrels
Material sources:	Immediately after the earthquake for first 80 classrooms construction materials imported from U.S: timber, roofing sheets, steel straps, plywood, insulation, gutters Subsequent construction: Wood, plywood, concrete, and other materials were sourced locally
Approx. project cost per unit:	20,000-30,000 USD (price variation between construction company or trained construction crew)
Approx. material cost per unit:	10,000-15,000 USD
Size of units:	Classroom: 7.2mx7.2m, 52sqm
Size of construction team:	8-10 crew members: 1 foreman with carpentry experience and trained in the classroom module construction; 3 carpenters with moderate experience; 4-6 labourers with minimal carpentry skills
Construction skill required:	Basic carpentry skills required (structure designed by repetitive construction procedures)
Who built the facilities:	Timber structure: local men (18-25 years old) trained by architect Cascading training principle: Original crew trained subsequent builders. Concrete works by local contractor
Site information:	Classrooms, WASH facilities built on 20 different sites. Site conditions vary from dense wooded areas, mountain top villages, existing schoolyards of damaged buildings to dense urban sites. Typically 2 to 5 classroom modules per site.

Background

In 2010 an earthquake of magnitude 7.0 struck near Port-au-Prince, Haiti's capital, causing dramatic destruction. An estimated 3.5 million people were directly affected by the earthquake. Over 300,000 were killed, a further 300,000 injured, and 1.6 million forced into displacement.

3,978 schools were damaged, more than 77% of the existing public education infrastructure. The education cluster estimates that 90% of schools in Port-au-Prince and Leogane and 60% of the schools in the South and West departments have been partially damaged or destroyed, affecting some 500,000 children age 5-14 (48% girls). Even before the earthquake, 49% of children were not enrolled in school.

Before the earthquake, access to improved drinking water (63% in 2008, up from 47% in 1990) was improving, but was still not on track to meet the Millennium Development Goals (MDGs). Poor access to water was also the case in schools; even before the earthquake, 40% of schools didn't have access to drinking water. In respect to improved sanitation, infrastructure access was extremely low and had actually been decreasing (17% in 2008, down from 26% in 1990), and 60% of schools didn't have a sanitation facility. Combined with the lack of access to drinking water in schools, a total of over 873,000 children were being exposed to waterborne diseases at school.

After the earthquake, 94% of schools were found to lack a water, sanitation and hygiene (WASH) facility or proper hygiene promotion practice that is critical to ensure a healthy environment for students.

Project Description

The construction programme of the Transitional Learning Space is imbedded within a holistic approach to ensure education programming is implemented within the larger context of recovery and reconstruction. The overall project has an approximate duration of five to ten years. Key components included teacher; school directors training; setting up of parent teacher associations; provision of transitional classrooms with WASH facilities and hygiene practice; teaching and learning materials; support for Early Childhood Care and Development; school-based health and nutrition services and youth and community participation.

Different spatial site layouts were designed to correspond to the variety of sites, including dense urban sites and rural locations. In principle, all schools had double classrooms layouts, latrines, hand wash points and drinking water, as well as secure external play spaces. The school grounds were protected by existing perimeter fences or walls. The provision of ramps into classrooms and latrines was included.

The TLSs were predominately constructed by local community members. In the beginning of the construction process the architect trained a working crew of 15 local men from Jacmel between the ages of 18-25 with little to no prior carpentry experience. The crew worked directly for Plan. Under the training/supervision of the architect, the crew built the first timber-framed structure of the classroom module in eight days. After the first module the crew understood the construction well enough to build subsequent modules on its own. This original crew trained subsequent working groups. The in-situ concrete works for the foundations were subcontracted out by Plan to local construction companies.

TLS Summary

Typically, a twin classroom module was constructed. The size of the individual classroom was 7.2m x 7.2m with an internal size of 52sqm. The classrooms were designed for a timber structure instead of the traditional concrete block structures found in Haiti for speed of construction, structural stability, and that the buildings would be constructed by unskilled workers.

The main construction components are timber wall panels and trusses. The pieces of these components were pre-cut to length in a workshop and assembled on site. This approach meant only a few skilled workers were needed to make all of the critical cuts, and the on site work consisted primarily of assembling the pre-cut parts.

The classroom foundations are made from compacted concrete rubble, a continuous concrete perimeter strip footing with cast-in-place steel anchor straps that provide ballast in high wind and fasten the timber structure securely to the concrete base. The cast concrete slab over the compacted rubble serves as an inexpensive and durable classroom floor. Concrete block base perimeter and centre walls with cement mortar levelling bed elevates the timber structure above the ground and protects the structure from minor flooding. The main structure is made from timber stud structure with diagonal corner bracing. The timber walls are fastened to steel anchor straps providing the structure's wind resistance. Three-quarter inch plywood shear panels cladding at the tops and bases of walls provides lateral resistance and enclosure as well as tying wood stud wall panels together. Plywood panelling on the dividing wall separates the two classrooms. The roof structure is made from timber trusses assembled on site from pre-cut wood components with screws and nails. Steel strap connections between the truss and walls provide wind uplift resistance. Wood slats are attached to wood stud panels creating even lighting and protection from the elements while allowing maximum ventilation. The roof has a thermal foil barrier over the timber purlins to reduce heat gain and creates ventilation channels under corrugated roof sheeting. Steel gutter and rain barrel water collection systems were installed to provide water for irrigation and washing.

For detailed construction manual, please contact: Jack Ryan: johnjackryan@hotmail.com, Robin Costello: robin.costello@planusa.org

DRR

The project included discussions of the root causes of vulnerability and to ensure a holistic approach to the country's risk profile – including hazards such as earthquakes, floods, landslides, as well as social risks such as child trafficking, child protection, violence and abuse. A children-friendly methodology was developed and applied through a series of focus group discussions to have the opportunity to share views for the future of Haiti.

Maintenance

For durability the timber structure was painted to protect from weathering



Photo: Jack Ryan

Internal view of timber double classroom for Fleur de Chou school



Photo: Plan international

Construction of school latrines



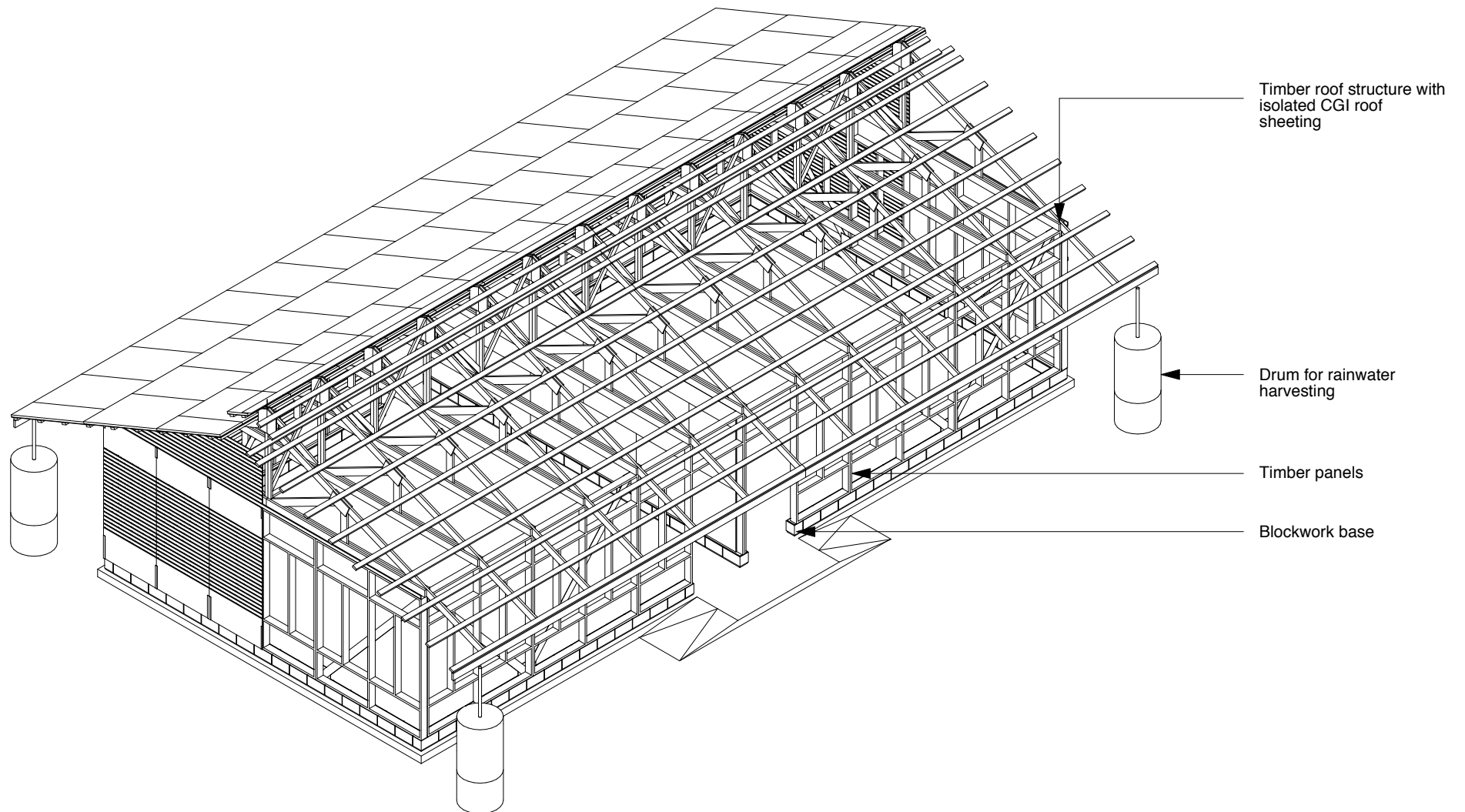
Photo: Plan international Natasha Fillion

Internal view of timber double classroom for Fereres Clement school

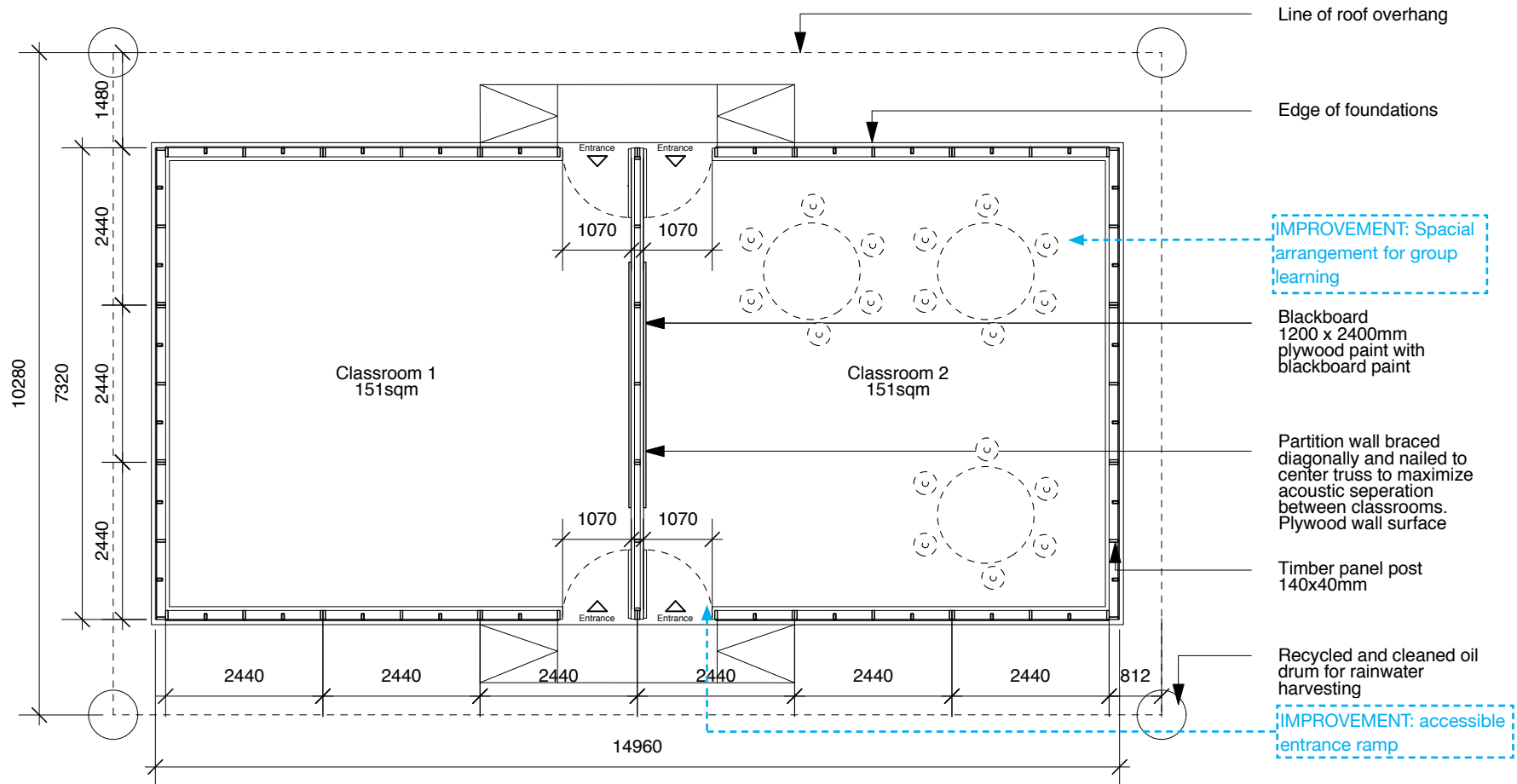


Photo: Jack Ryan

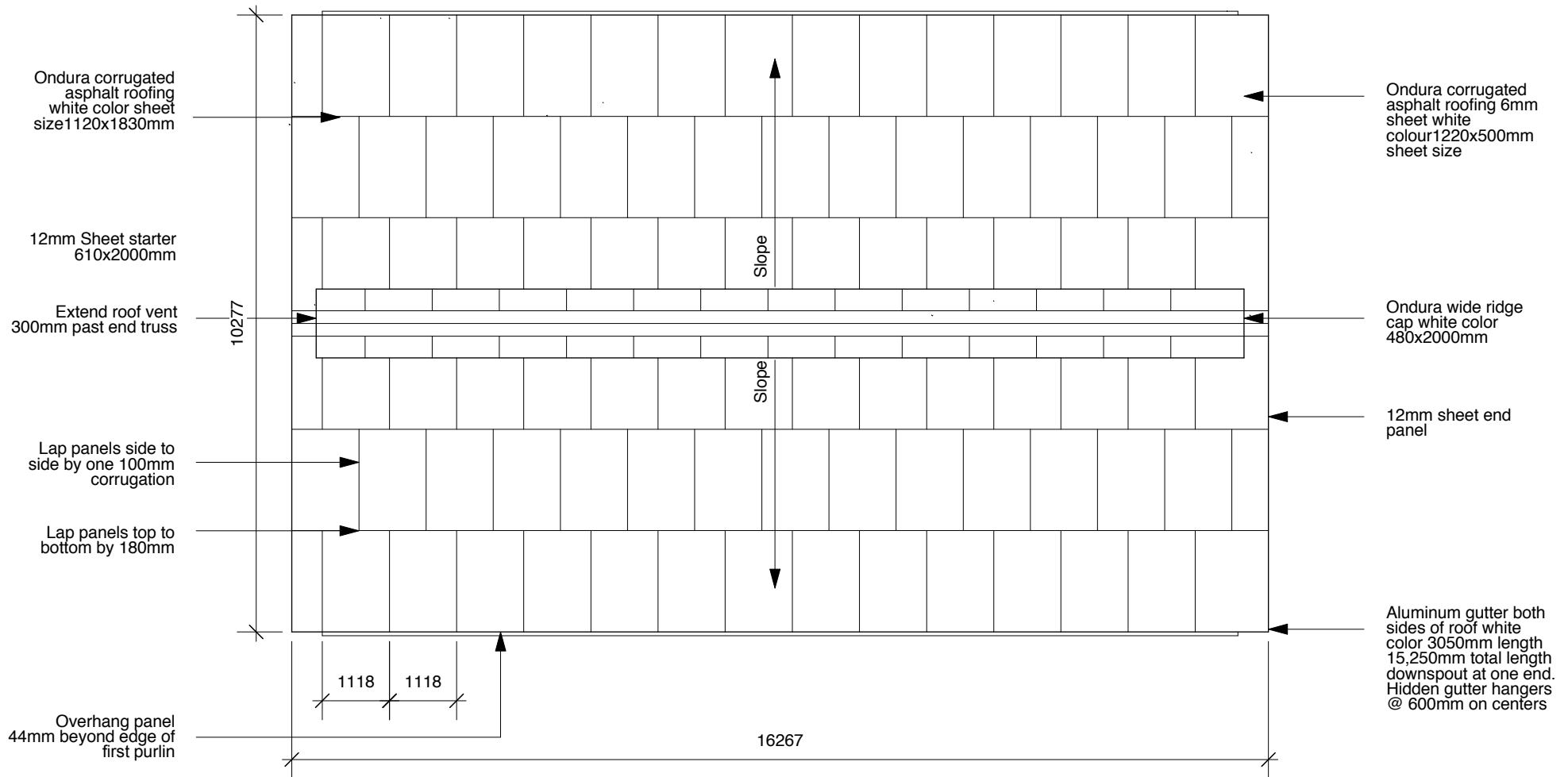
Construction sequence



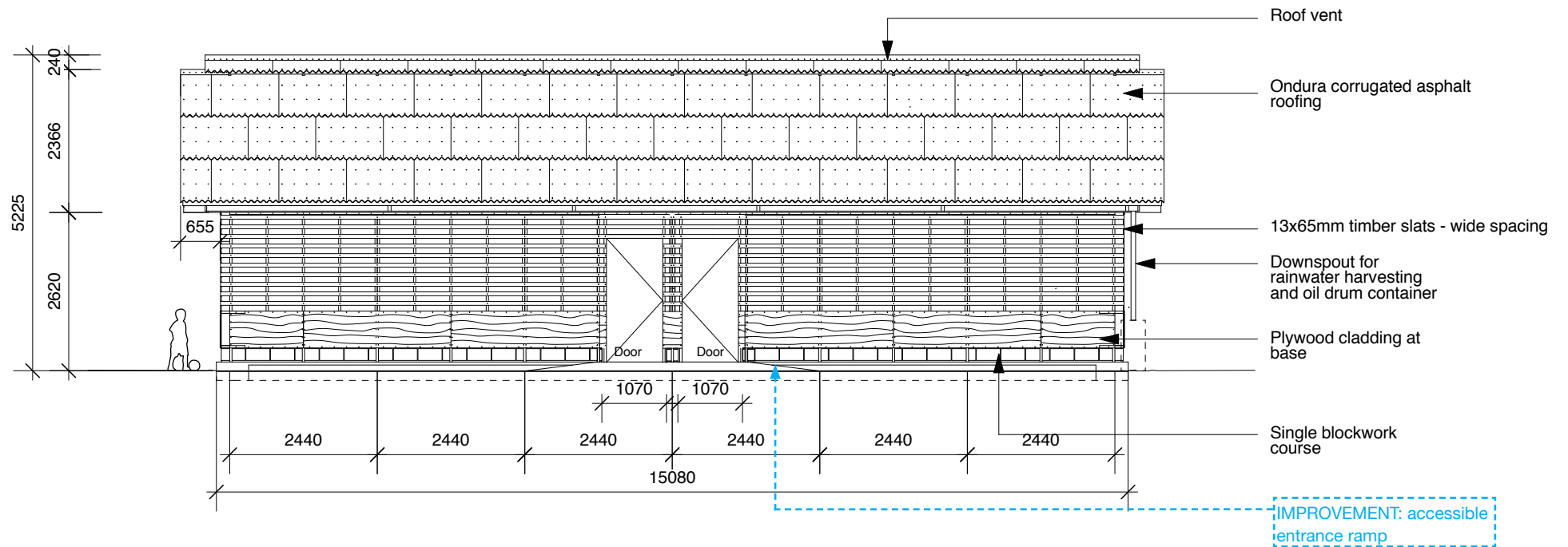
Note: drawing not to scale, for illustrative purpose only



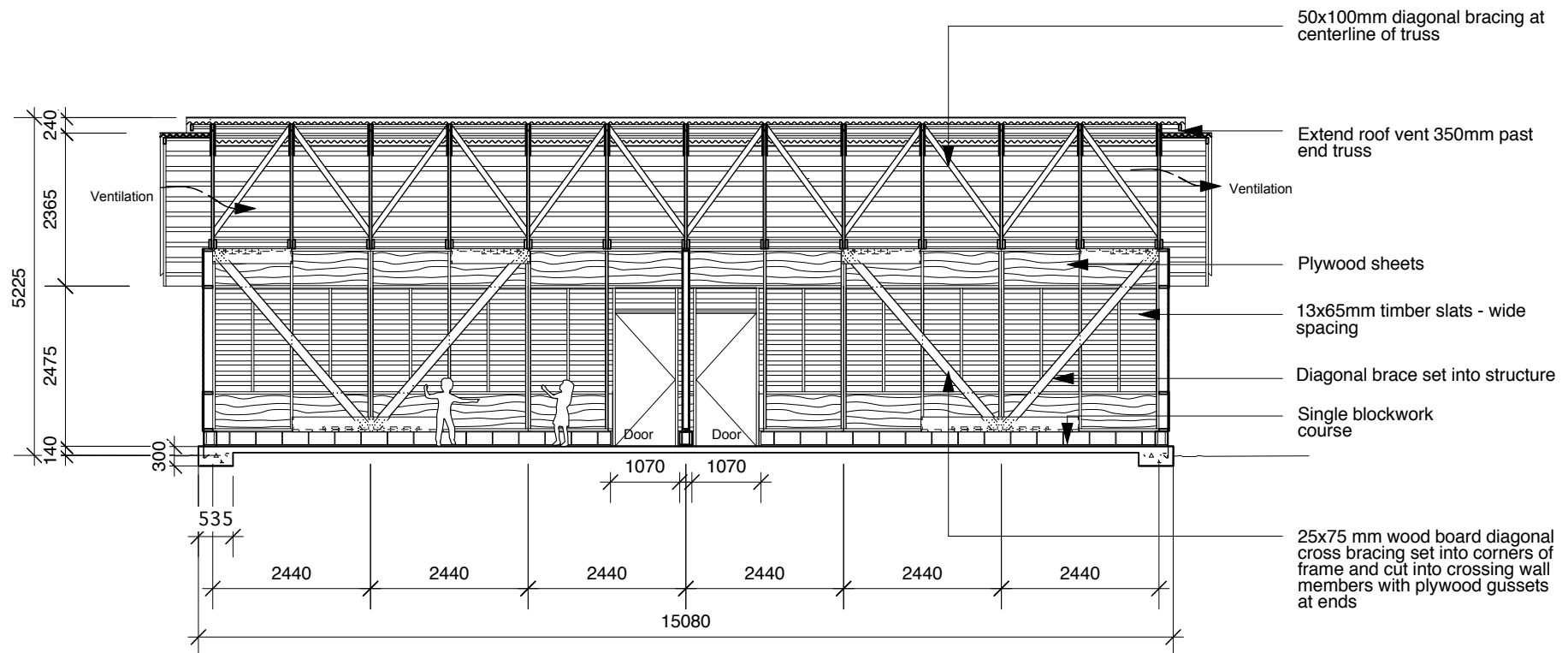
Scale 1:100



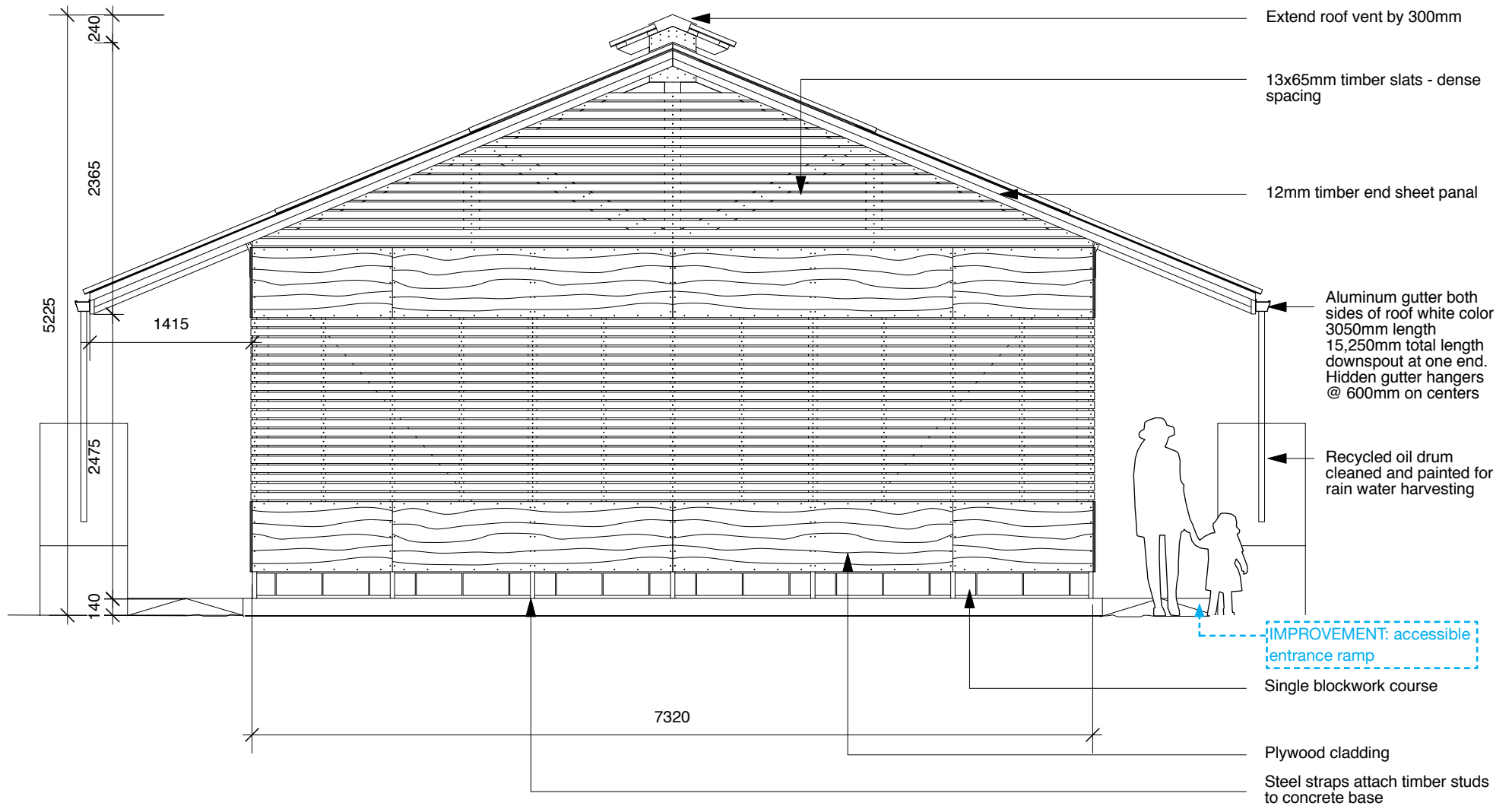
Scale 1:100



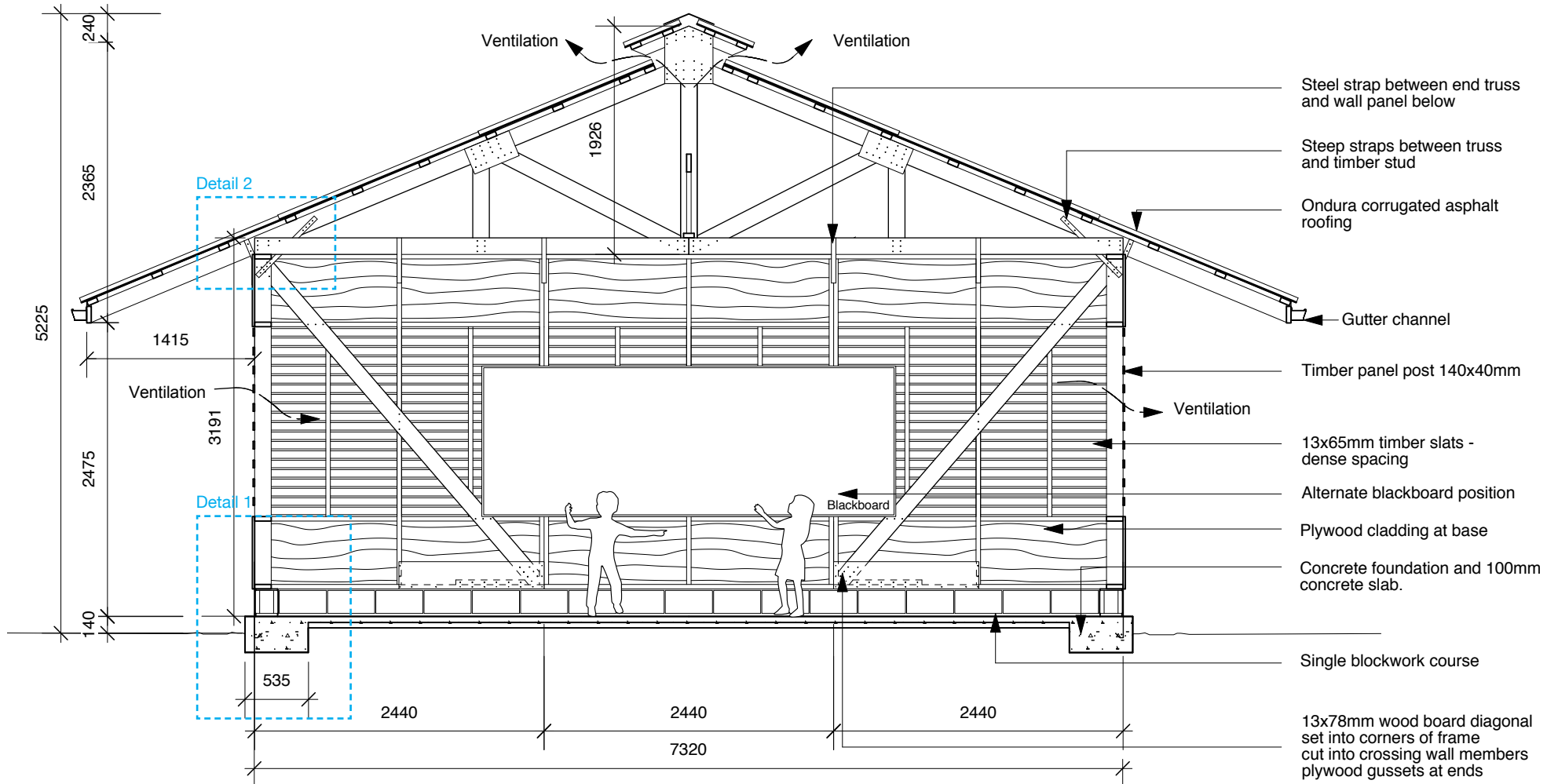
Scale 1:100



Scale 1:100



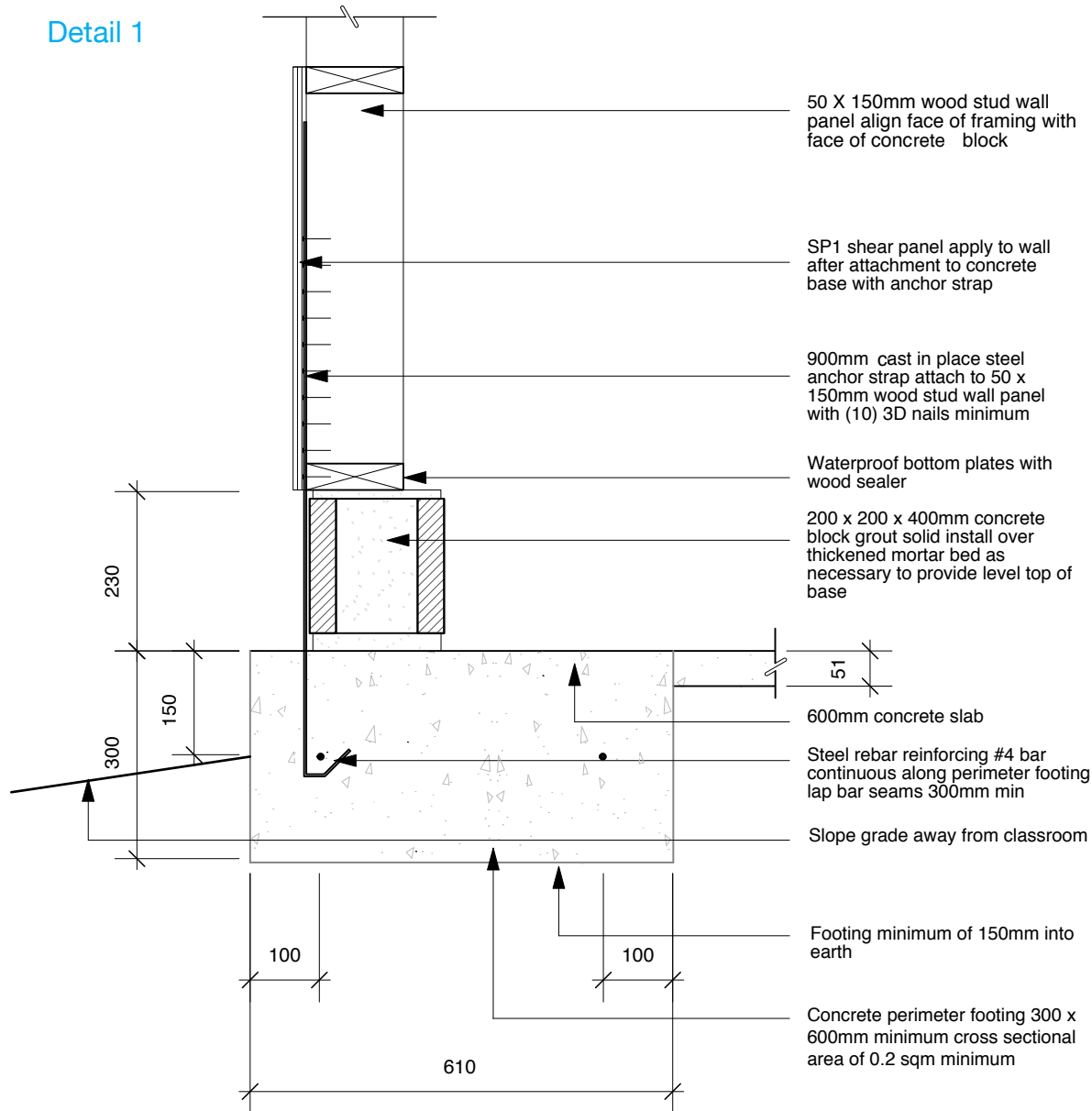
Scale 1:50



- Steel strap between end truss and wall panel below
- Steep straps between truss and timber stud
- Ondura corrugated asphalt roofing
- Gutter channel
- Timber panel post 140x40mm
- Ventilation
- 13x65mm timber slats - dense spacing
- Alternate blackboard position
- Plywood cladding at base
- Concrete foundation and 100mm concrete slab.
- Single blockwork course
- 13x78mm wood board diagonal set into corners of frame cut into crossing wall members plywood gussets at ends

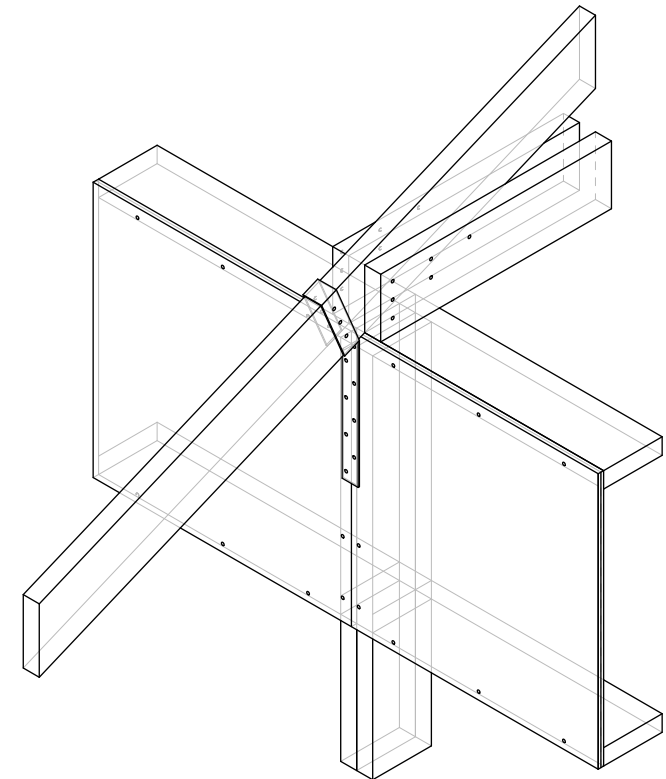
Scale 1:50

Detail 1



Section detail: Footing and block base (1:10)

Detail 2



illustrative purpose only

Section detail at wall/ truss junction

Quantities for double unit 100sqm**Elements****Foundation**

Elements	Unit	Quantity
Concrete	m ³	29
600mm Anchor Sreap - J-Shape	no.	22
#4 Steel Rebar - 12mm dia	m	92
8'x8'x16' Concrete Block	no.	114

Walls

Wood Preservative	L	150
Timber: 600x1800x3000mm Wood Stud	no.	51
Timber: 600x1800x3600mm Wood Stud	no.	235
Timber: 12x55mm Wood Slat	m	987
Timber: 1800x3650mm Wood Diagonal Brace	no.	12
Plywood: 1200x2400x18mm CDX Exterior Plywood	no.	22
Plywood: 1200x2400x12mm CDX Exterior Plywood	no.	15
60mm Deck Screws	lb	22.5

Roof

Metal Strapping - 0.037m Wide x 45m Coil	no.	4
Tyvek Therma-Wrap: 2.75x61m Roll	roll	2.5
Ondura Roofing Panels - 1200x2000mm - Premium Finish White	no.	100
Oondura Wide Ridge Cap - 480x2000mm - Premium Finish White	no.	10
Ondura 75mm Roofing Nails - White - 3,900 Per Box	kg	0.5
125x3000mm Gutter White Steel Gutter	no.	10
3000mm Downspout: White Steel	no.	2
125mm Downspout Drop: White Steel	no.	2

125mm Left Cap - White Steel	no.	2
125mm Right Cap - White Steel	no.	2
Hidden Hanger For 125mm Gutter	no.	50
Gutter Seamer/Adesive		10
37mm Roofing Nails	lb	9.8
Others		
1200x2400x20mm Finish Grade Plywood - For Blackboard	no.	2
Rain Barrel	no.	2
Spigot	no.	2
Concrete Base For Rain Barrels	no.	24
16D Nails	lb	12
8D Nails	lb	15
Wood Preservative	ga	10
Chalkboard Paint	qt	1



Photo: Save the Children, Andrew Powell

External view of masonry/timber version

HAITI

2010 / Earthquake / Save the Children

Agency:	Save the Children
Location:	Haiti, Port-au-Prince (PAP), Leogane and Jacmel
No. of users:	Built for 40 children per classroom (estimated to be more)
Anticipated lifespan:	All timber frame 5- 10 yrs +, timber and masonry 10 yrs +
Actual lifespan:	Not known yet
Facilities provided:	Gender separated WASH facilities (including latrines, hand washing points, improved hygiene practice (water harvesting), playground, walls for security and admin building (depends on needs, existing facilities, space available and existing
No. of facilities:	45 schools with average of 4-6 classrooms

Construction time:	PAP: 10-12 weeks, outside of PAP: 6-8 weeks
Main construction materials:	Mountain stone foundations, concrete ring beams, cement blocks, wooden super structure and Zinc sheet roof
Material sources:	Locally if available but some had to be imported e.g. treated timber
Approx. project cost per unit:	USD18,000perclassroom(Port-au-Prince/2010);USD12,000 in Jacmel
Size of units:	52sqm (internal dimension)
Size of construction team:	20 people (1 x program manager, 1 x deputy program manager, 2-6 Engineers, 1-4 DRR mobilizers in each field site).
Construction skill required:	Project Management, engineering, supervision, quality control and contract management
Who built the facilities:	Local contractor supervised by Safer Construction and DRR staff from Save the Children
Site information:	Built on existing site, demolition was required. Principle considerations: flooding, land slides, hurricanes and earthquakes. Land ownership issues in PAP

Background

In 2010 an earthquake of magnitude 7.0 struck near Port-au-Prince, Haiti's capital, causing dramatic destruction. An estimated 3.5 million people were directly affected by the earthquake. Over 300,000 were killed, a further 300,000 injured, and 1.6 million forced into displacement.

3,978 schools were damaged, more than 77% of the existing public education infrastructure. The education cluster estimates that 90% of schools in Port-au-Prince and Leogane and 60% of the schools in the South and West departments have been partially damaged or destroyed, affecting some 500,000 children age 5-14 (48% girls). Even before the earthquake, 49% of children were not enrolled in school.

Before the earthquake, access to improved drinking water went up from 47% in 1990 to 63% in 2008, but was still not on track to meet the Millennium Development Goals (MDGs). Poor access to water was also the case in schools; even before the earthquake, 40% of schools didn't have access to drinking water. In respect to improved sanitation, infrastructure access was extremely low and had actually been decreasing (17% in 2008, down from 26% in 1990), and 60% of schools didn't have a sanitation facility. Combined with the lack of access to drinking water in schools, a total of over 873,000 children were being exposed to waterborne diseases at school.

After the earthquake, 94% of schools were found to lack a water, sanitation and hygiene (WASH) facility or proper hygiene promotion practice that is critical to ensure a healthy environment for students.

Project Description

The project's aim is to provide increased access to quality education for vulnerable children in Haiti, through development of community-based education and QEI (quality education initiative) holistic package of support. The objective is to increase access to a safe learning environment by provision of adequate size and quality of classrooms, gender-separated WASH facilities of latrines, hand washing points, water harvesting, external play area (if site restriction permits) and school ground protection walls/fences.

The school directors were shown the design developed in consultation with Development Workshop France (DWF) so as to understand the earthquake and hurricane resistance principles adopted. The layout of classrooms, latrines and water harvesting were developed in consultation with school representatives. Maintenance training and disaster risk reduction (DRR) activities are undertaken with Parent Teachers Association (PTA), teachers and community representatives. The construction was carried out by local contractors supervised by the Save the Children technical team. In Jacmel the community members constructed the façade elements. To date 41 classes have been built in Port-au-Prince and 80 classrooms are completed in Jacmel.

Different construction and site issues arose between urban Port-au-Prince and more rural sites in Jacmel in respect to construction time, cost and land ownership disputes.

TLS Summary

Two construction types were available which have different wall construction: timber structure with stone infill (see photo left, option 1) or half masonry/timber structure (option 2). These two construction types were amended to suit the individual site constraints and requirements. For example: multiple classroom designs were built in Jacmel and PAP (refer to photo page) with specific

roof constructions.

The classroom unit measures 5m x 10.5m of internal usable space and an average of 1.2sqm per student. It is 3.9m tall to the ridge beam and 2.6m to the eaves. There are three types of cladding: timber slated on gable end for ventilation and lighting, plywood cladding to external walls, and woven palm leaves in timber frame to form top hung, outwards opening shutters. To allow the inside classroom to be well ventilated in the hot climate, the roof has a ventilation ridge detail (refer to section B–B).

The structure needs to respond to multiple hazards: earthquake, landslides, flooding and hurricane winds. To protect the structure from hurricane damage, the roof has a 30 degree slope, special hurricane ties connect the roof rafters to the wall ring beam and the CGI roof sheeting is fixed to purlins below with galvanised nails and hurricane strapping. In response to the risk of earthquake damage, the structure has continuous stone strip foundations and a concrete ring beam tied together by concrete anchors. The masonry and timber wall structure is fixed back securely by earthquake resistant detail (refer to detail x-x) to concert ring beam. The roof rafters are joined with plywood gusset plates and horizontal and vertical bracing fastens all structural elements together (roof rafters/walls/foundations). A detailed construction manual is available for this design with detailed descriptions of earthquake and hurricane resistant construction details. (Contact Save the Children Haiti for detail)

DRR

There is an ongoing relationship with the schools as they are all part of the quality education programme. The schools receive teacher training, school materials and support. Ongoing DRR training will be given after construction has been completed.

Maintenance

Maintenance advice and manual was given to the schools. There is a six-month liability period for the contractors to rectify any defects.

Challenges

- Sourcing quality and correctly treated wood and blocks was a challenge. SAVE provided training and equipment to improve the quality of the blocks, sand, gravel and hurricane straps/connectors. Good quality sand, gravel and stones were available but the contractors often sourced poor quality, as it was cheaper and easier to obtain. In Jacmel, SAVE trained local steel contractors to produce hurricane straps and connectors.
- Land ownership disputes within urban areas of Port-au-Prince created construction delays. Despite getting lawyers to check paperwork before starting construction one school had to be stopped because of a land dispute.

Improvements

- Consideration to accessibility should be given in forms of ramps into classrooms and other facilities



Photo: Save the Children, Andrew Powell

External view of masonry/timber TLS version for Ecole Siloe in Jacmel, next to damaged school building



Photo: Save the Children, Andrew Powell

Internal view of masonry/timber TLS version for Ecole Siloe in Jacmel, showing internal natural lighting condition



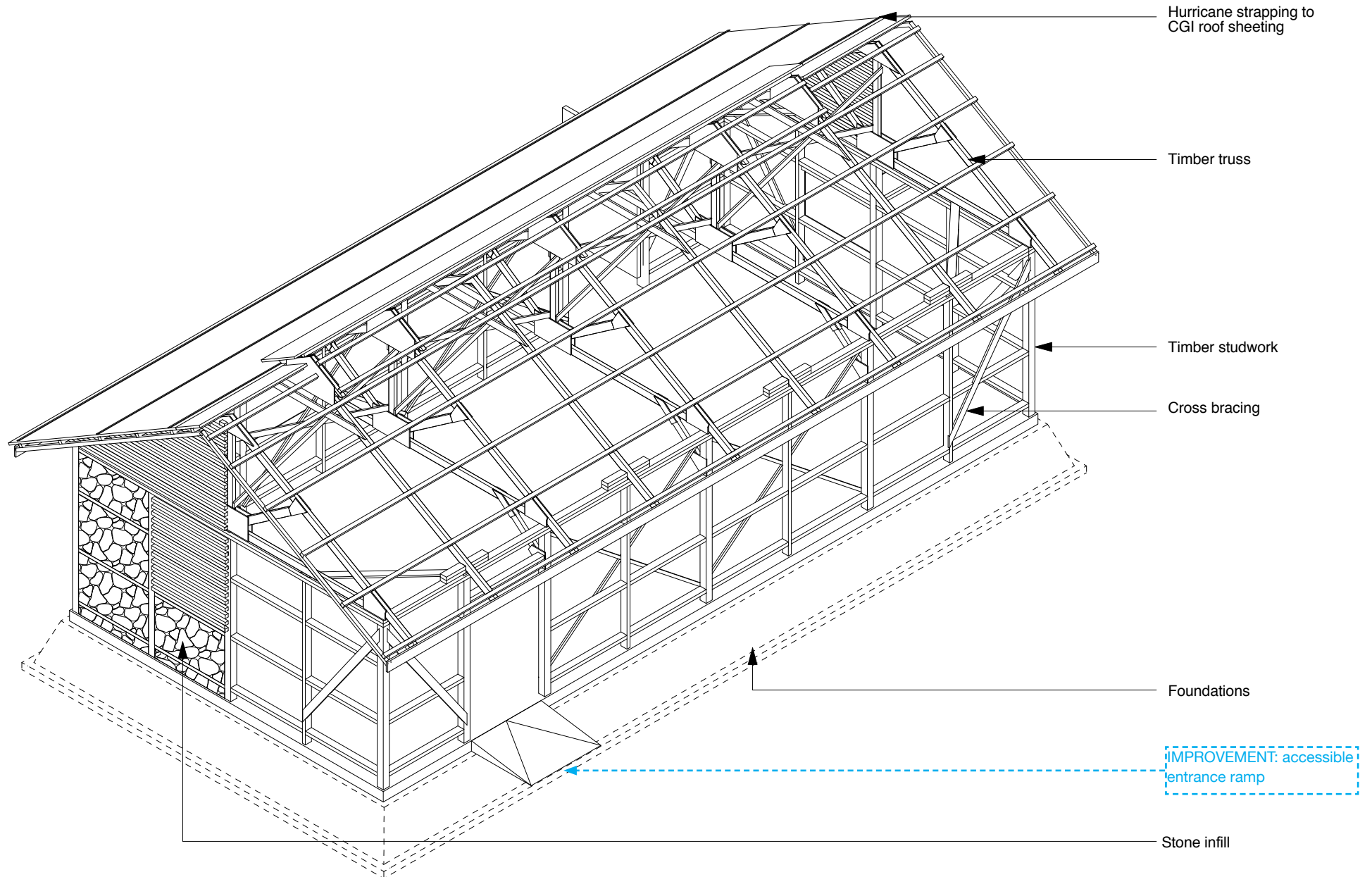
Photo: Save the Children, Andrew Powell

Internal view of upgraded timber version

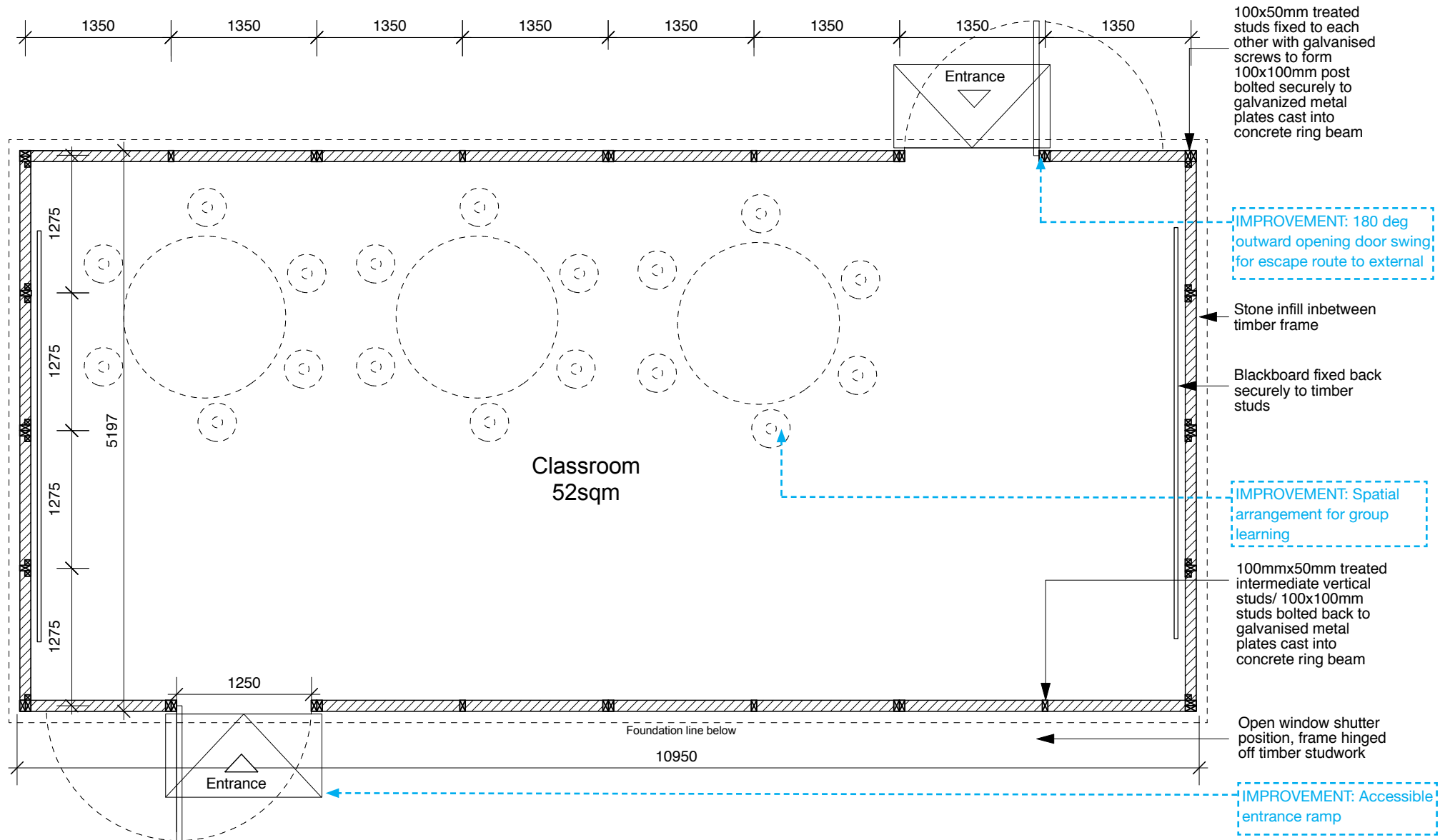


Photo: Save the Children, Paul Neale

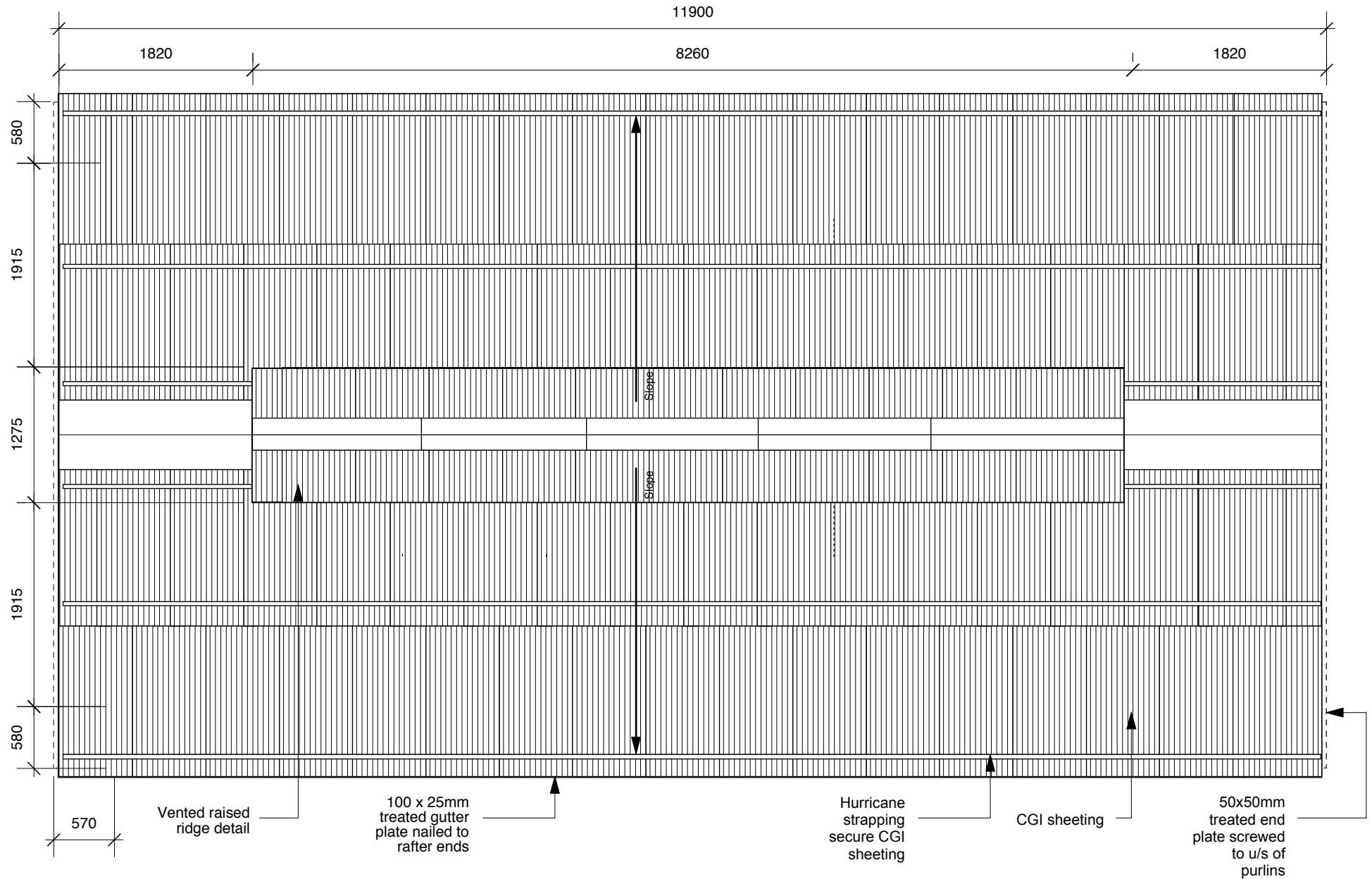
External view of masonry/timber classrooms for Eddy Pascal school in Port-au-Prince



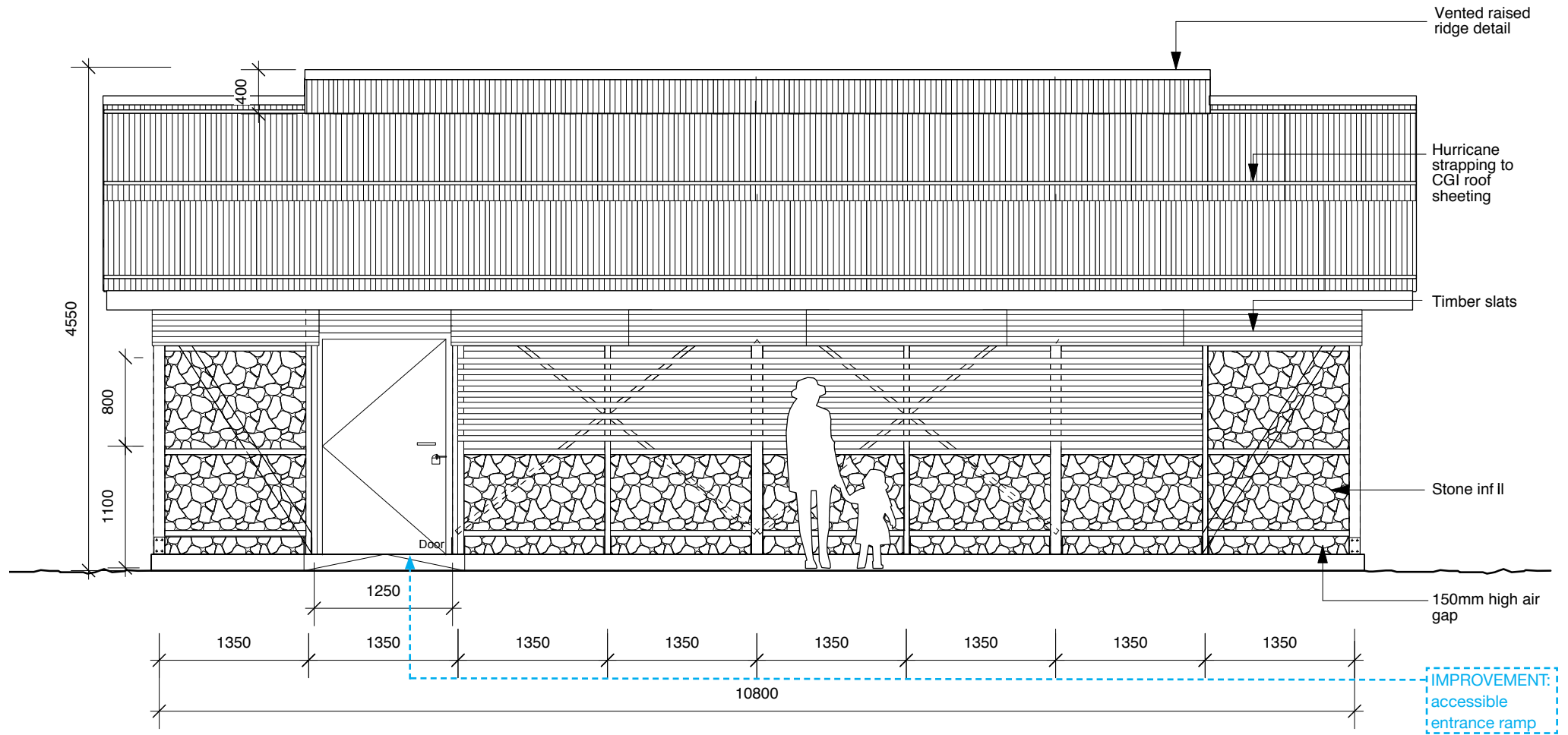
Note: drawing not to scale, for illustrative purpose only



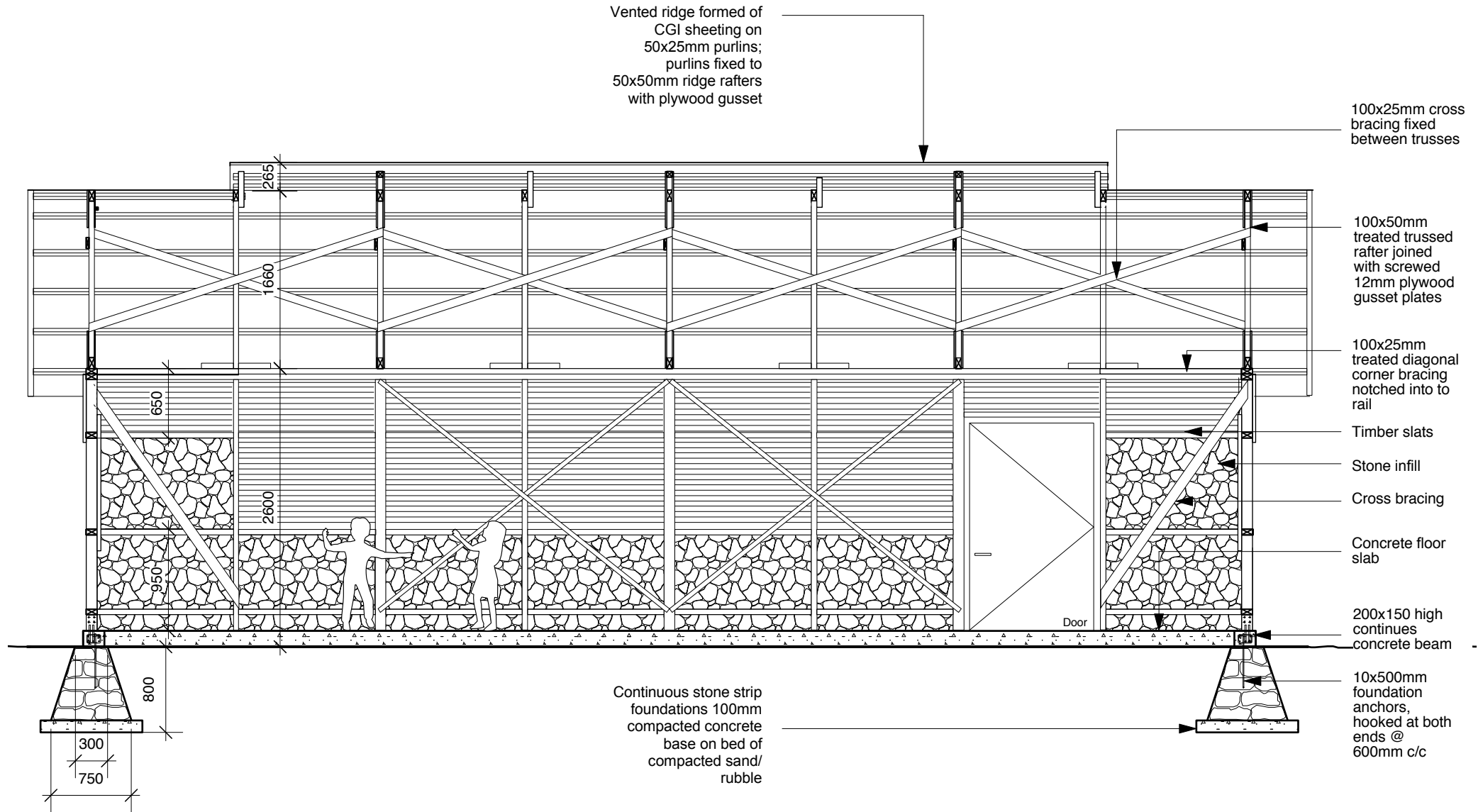
Scale 1:50



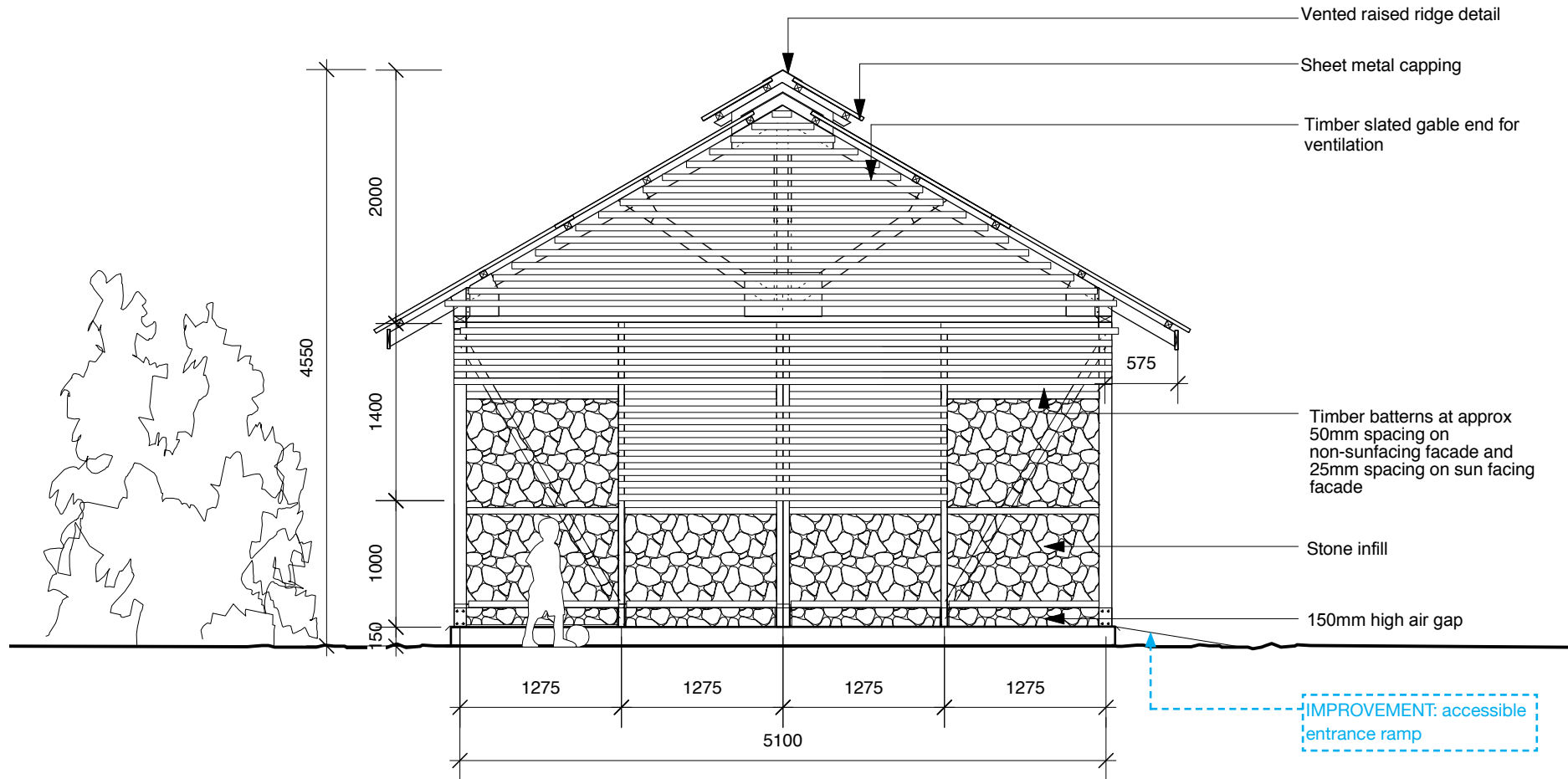
Scale 1:50



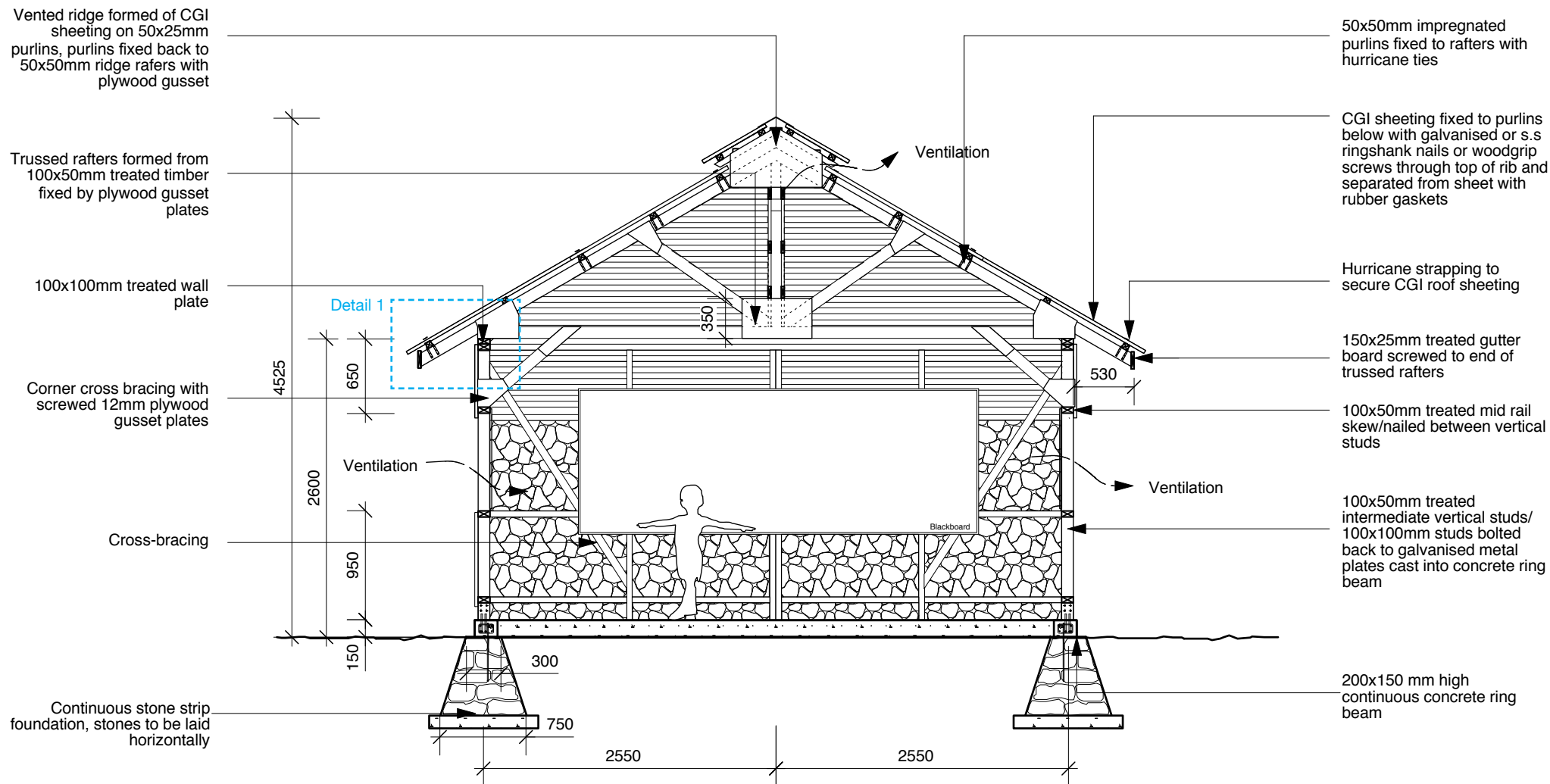
Scale 1:50



Scale 1:50



Scale 1:50



Scale 1:50

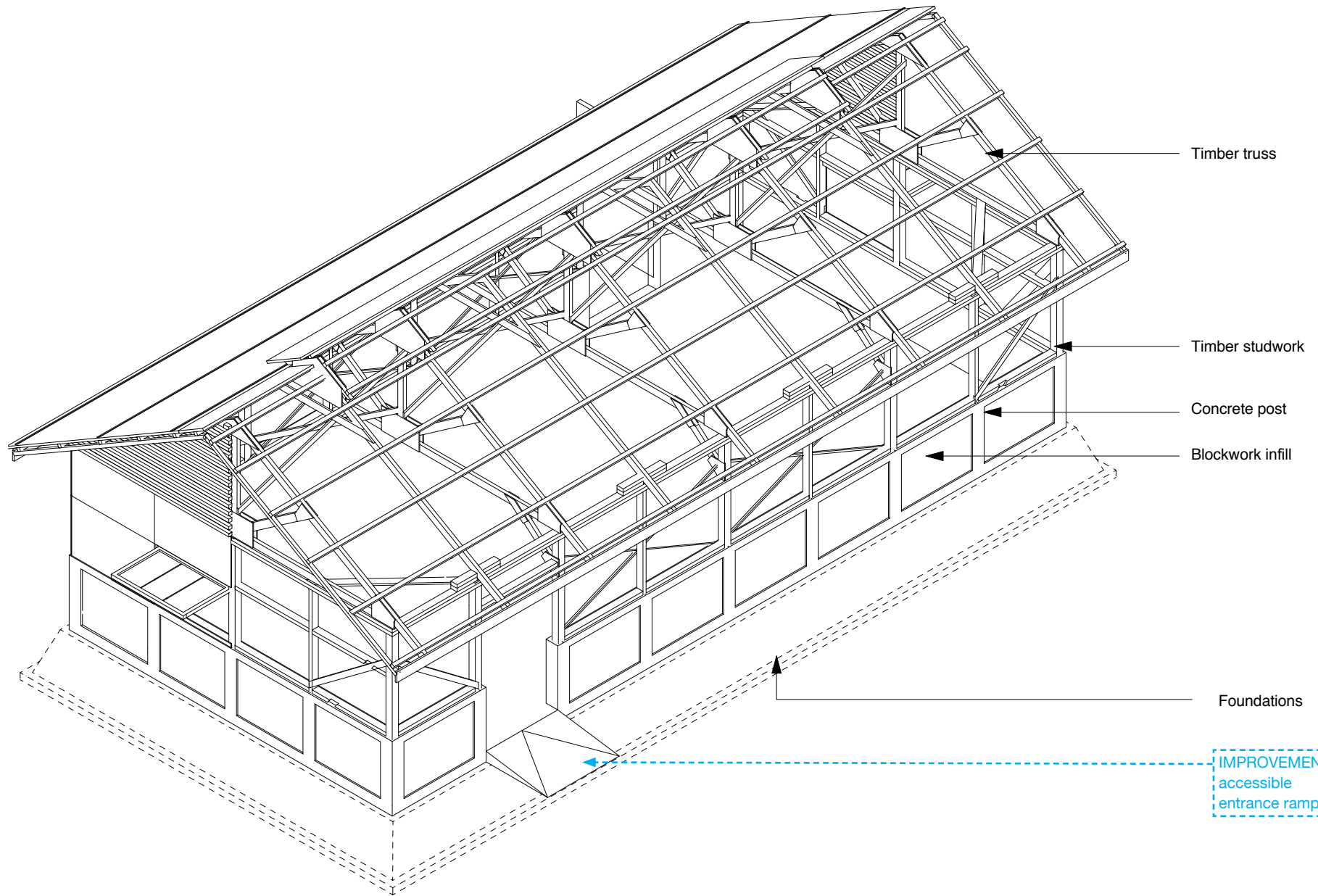
Quantities for single unit 50sqm		
Elements	Unit	Quantity
Site Preparation		
Mobilization & site preparation including rubble clearing, theodolite - topography, ground levelling.	L.S*	1
Site preparation as a result of adverse site typography	L.S	1
Excavation and earthwork		
Excavate for foundations.	m ³	33
Base course: 15cm thick crushed aggregate and gravel base course including levelling, watering and compaction.	m ³	4.5
Backfill	m ³	11
Foundations		
Blinding concrete: 40x10cm compacted concrete base using 1:2:3 mix laid on compacted sand or rubble.	m ³	3.2
Masonry		
Ground Beam: 30x20cm reinforced concrete sill beam using 1:2:3 mix. rectangular reinforcement of 4 no. T10 bar and T6 stirrups.	ml	30
Floor		
Hardcore Fill: 5cm thick hardcore and gravel hardcore fill including levelling, watering and compaction.	m ³	8
Slab: 10cm reinforced concrete slab using 1:2:3 mix. reinforcement grid with 50x50cm of T10 bar. Including formwork.	m ³	8
Walls		
Wall: wooden structure made with pressure impregnation treated wood, braced all together. Structure composed of 24 no. 245x10x-10cm posts, connected with 10x10x3,220cm top plate, 5x10x2,970cm sill plate & 5x10x2,970cm mid rail. Wall braced at the corners with 5x10x200cm side diagonal plates and 5x10x180cm top diagonal plates. Structure is connected to the ground beam through metal plate casted inside the ground beam and all are secured with bolts.	L.S	1
Gutter plate: 6"x1"x16'	ml	24

Sill plate: 100x50x4900mm	no.	32
Top plate: 100x50x4900mm	no.	64
Mid rail: 100x50x4900mm	no.	32
Post: 100x50x4900mm	no.	56
Bracing: 100x25x4900mm	no.	16
U profile bracket	no.	24
Gusset Plates plywood at the top and bottom of each corner (1.22x1.35m x12mm plywood)	no.	16
Roof		
Roof structure: wooden structure made with pressure impregnation treated wood, braced all together. Structure composed of 5 no. trussed rafters and 4 no. intermediate rafters are formed by 5x10cm section timber. Rafters are connected together with 10x5cm section Ridge beam. Rafters' connections are reinforced by 12mm plywood gusset plates. Rafters are braced together by 2.5x10cm section timber. Rafters are braced to post by 2.5x10cm section timber. Gutter plate fixed at gable sides using 2.5x15cm section timber. End plate fixed at gable end by 5x5cm section timber and nailed to purlins. 12 row of purlins with 5x5cm section timber are fixed above the structure. Vented raised ridge at top for ventilation.	L.S	1
Trussed rafter: 100x50x4900mm	no.	80
Intermediate rafter: 100x50x4900mm	no.	30
Intermediate rafter: 100x25x4900mm	no.	8
Bracing top wall: 100x25x4900mm	no.	8
Bracing post-trusses: 100x25x4900mm	no.	10
Cross bracing: 100x25x4900mm	no.	24
Gutter plate: 150x25x4900mm	no.	24
End plate: 50x50x4900mm	no.	13
Purlin: 50x50x4900mm	no.	161
Ridge rafter: 50x50x4900mm	no.	9

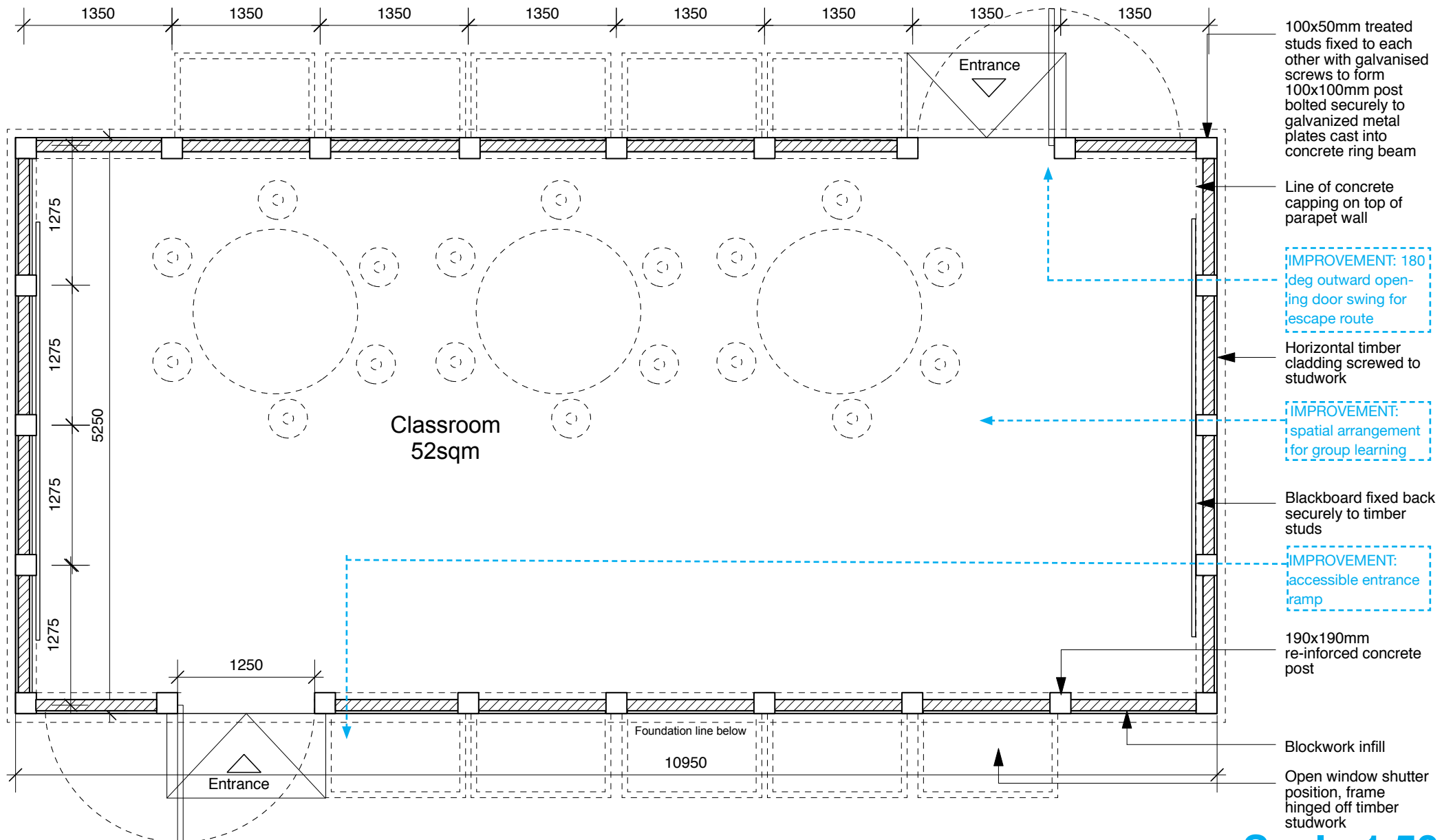
Elements	Unit	Quantity
Gusset plate: Plywood 1200 x 2400 x 12mm	no.	5
Roof Cover: 900x1800mm corrugated sheets (SWG 28) fixed to the roof structure using J hooks, 3mm dia, with bituminous guscate, nut & washer. The top is covered by ridge cap 4'x2' (SWG 28).	m ²	87
Strapping: 4x0.5cm galvanized hurricane straps with rubber gaskets placed longitudinally over corrugated sheet. Galvanized hurricane straps to connect purlins to rafters and rafters to top plate.	L.S	1
Treatment		
Preservative treatment of all timber at low level up to minimum 300mm	L.S	1
*L.S. - fixed price total work cost		

Field Notes:

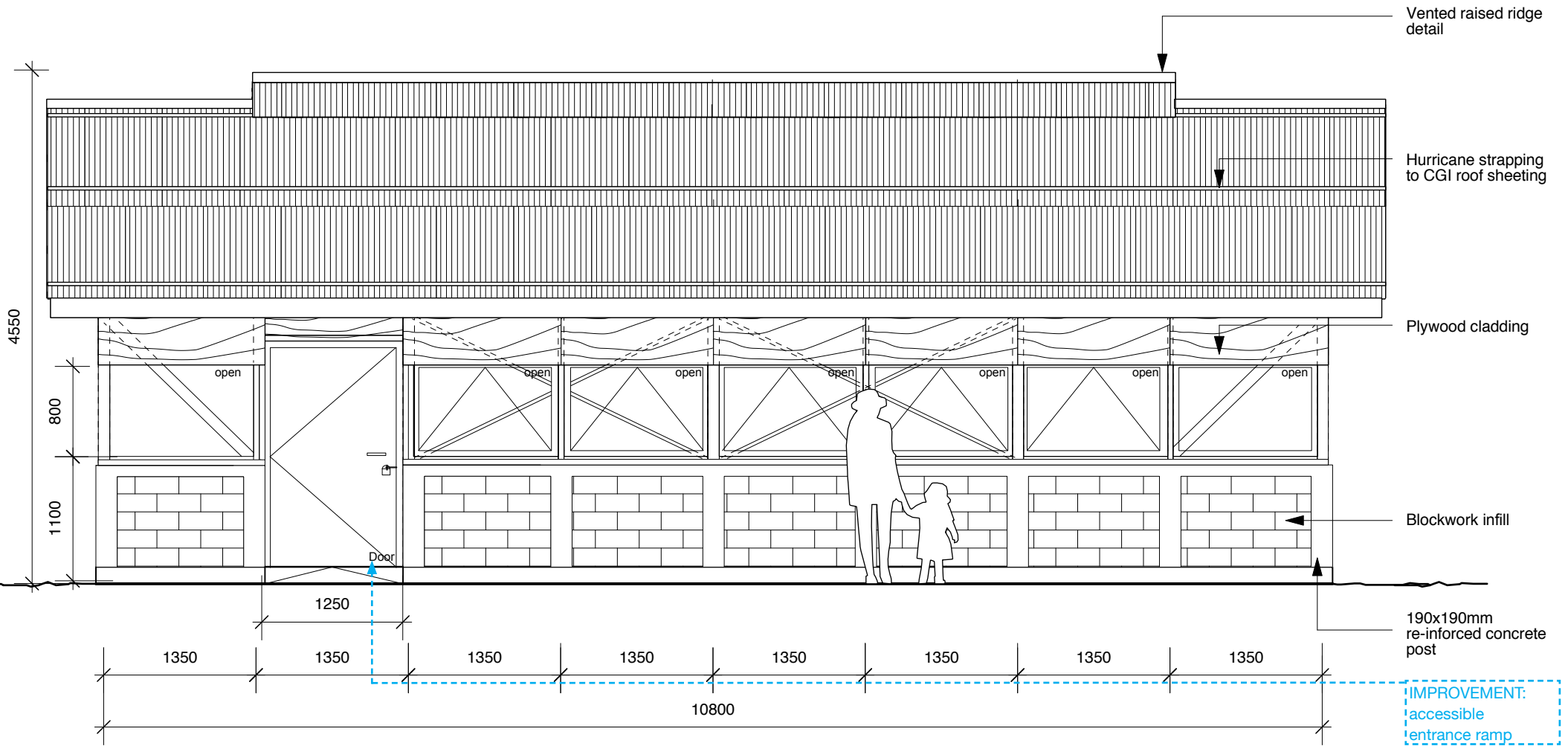
This is space for individual field notes, documentations and observations.



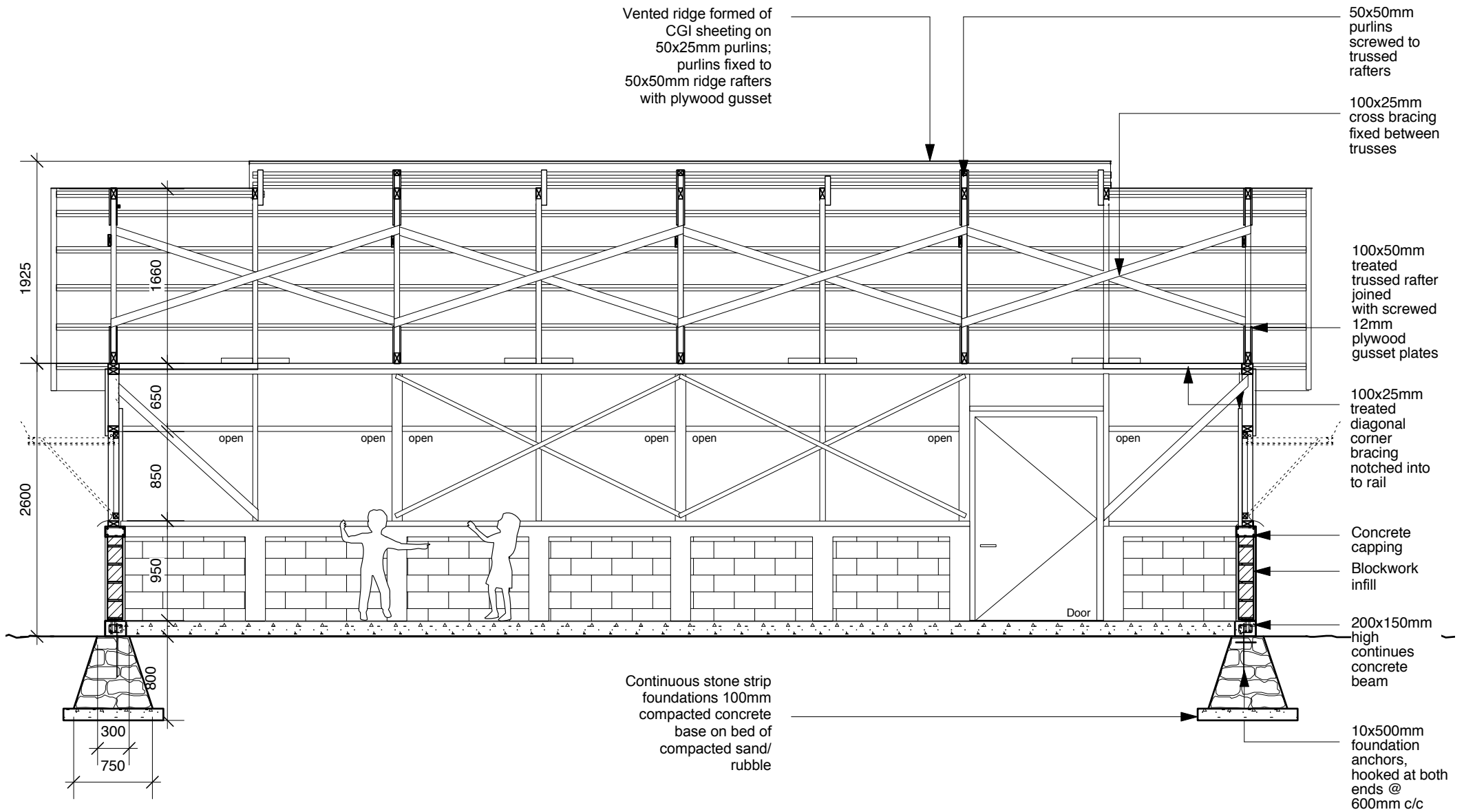
Note: drawing not to scale, for illustrative purpose only



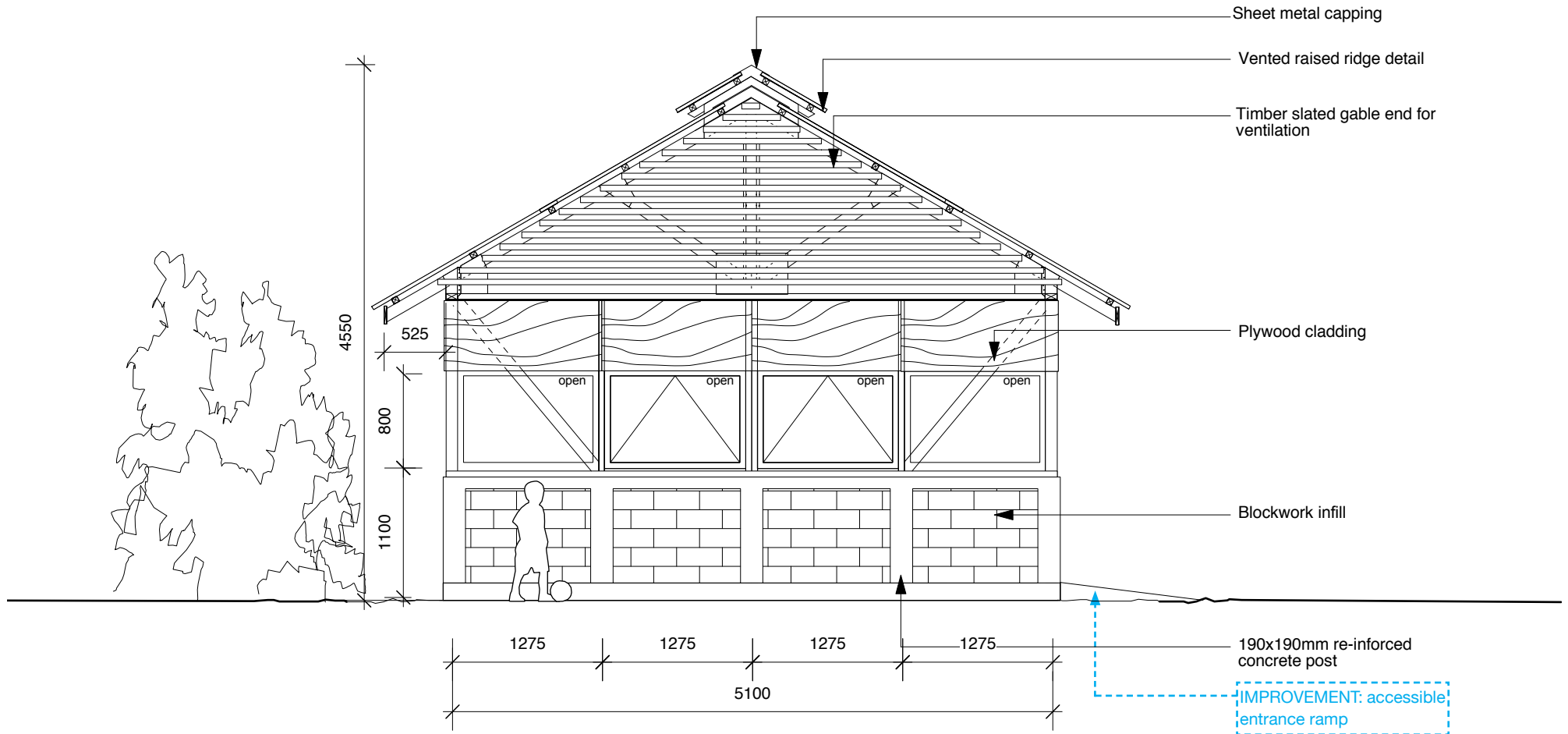
Scale 1:50



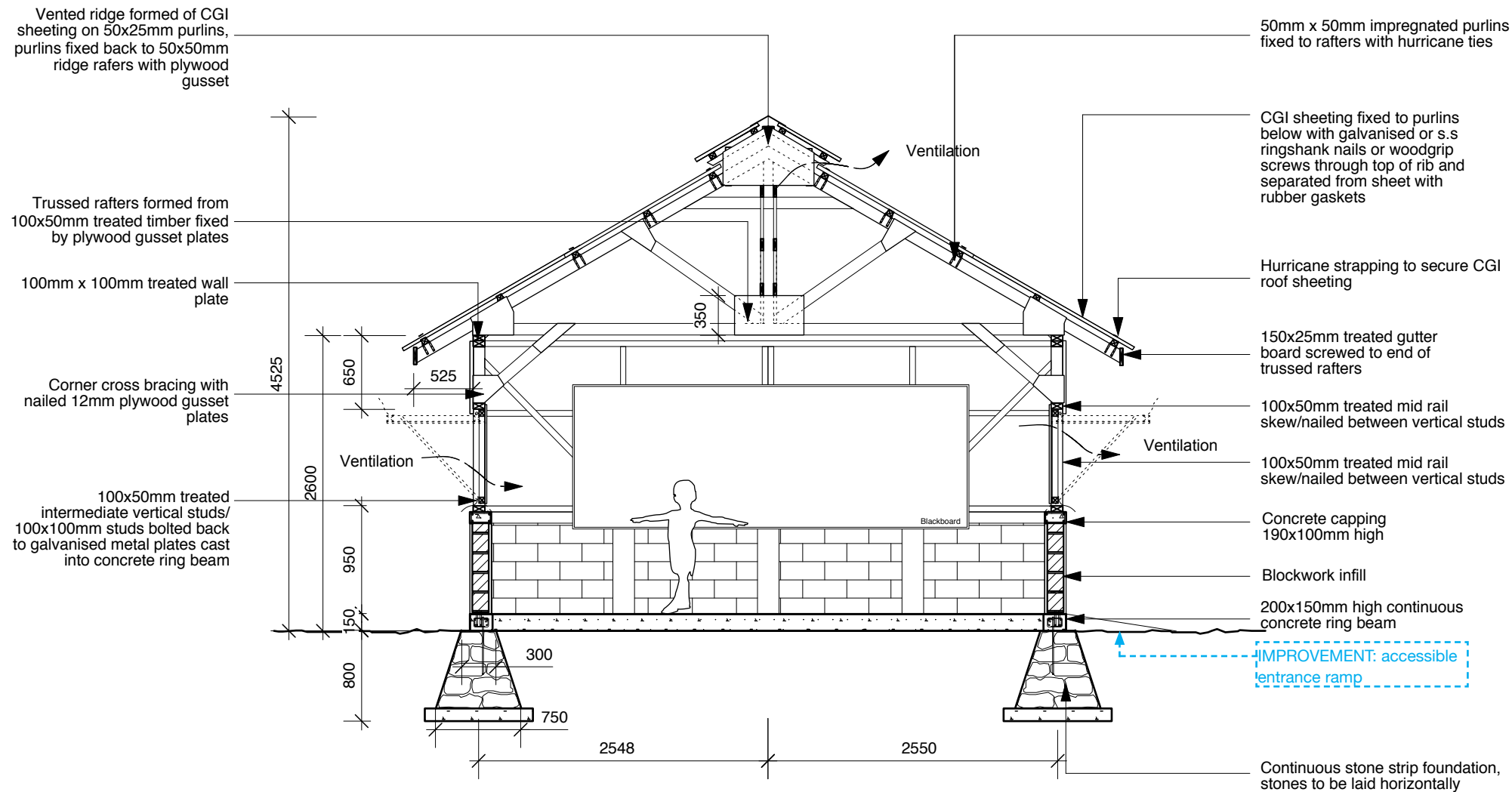
Scale 1:50



Scale 1:50

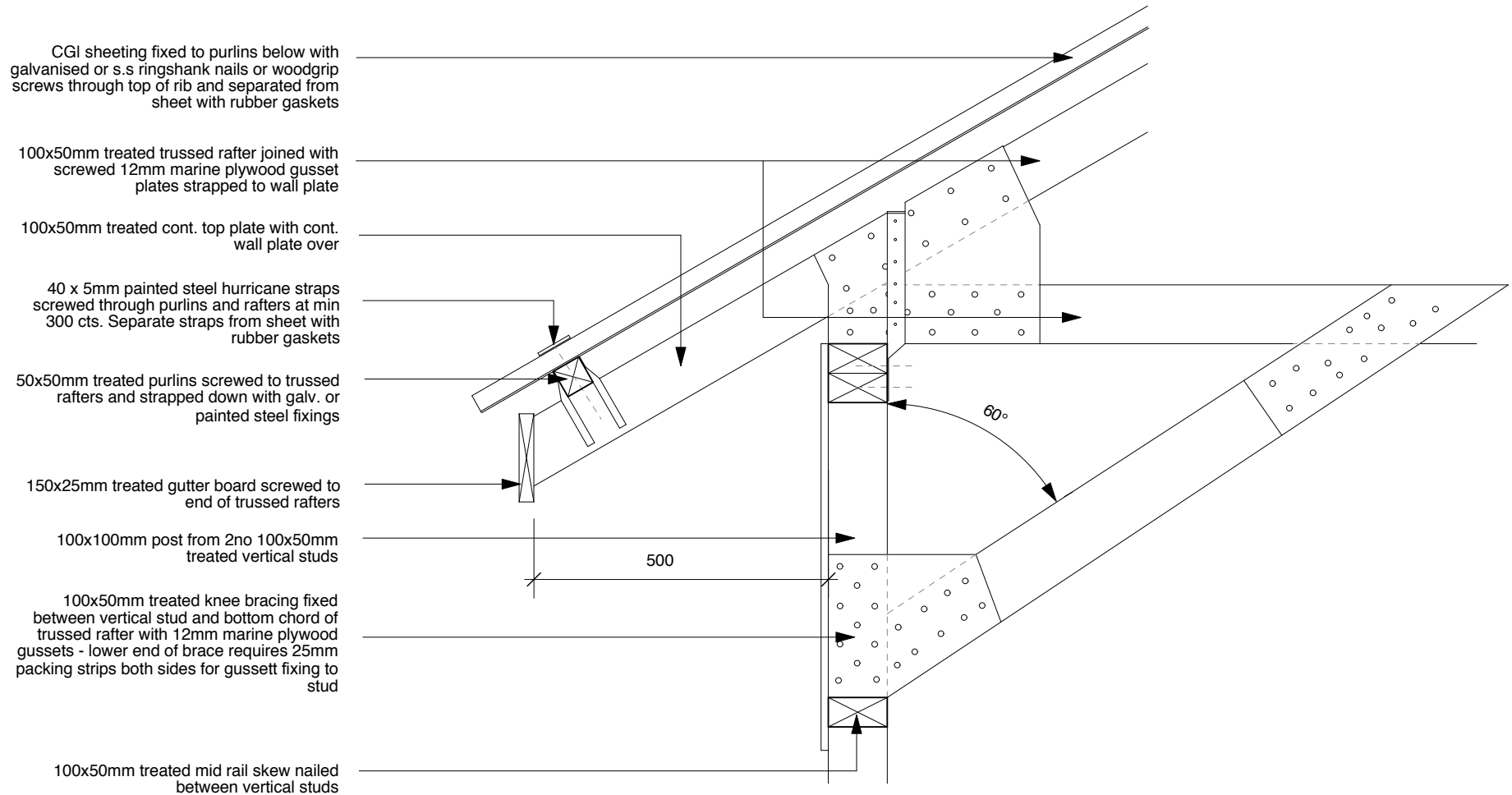


Scale 1:50



Scale 1:50

Detail 1



Standard eaves detail at main truss

Scale 1:10

Quantities for single unit 50sqm

Element	Unit	Quantity
Excavation and earthwork		
Mobilisation/layout	L.S	1
Excavate for foundations	m ³	33
Crushed aggregate and gravel base course, 15cm thick including levelling, watering and compaction	m ³	4.5
Backfill	m ³	11
Foundations		
Blinding concrete layer 10cm thick under foundations mix 1:2:3	m ³	3.2
Concrete mix 1:2:3	m ³	3.2
Stone foundations done with rough angular stones embedded and jointed in concrete mortar mix 1:2:3	m ³	13.5
Concrete	m ³	4.5
Stone	m ³	9
Anchors to connect the foundation to ring beam	ml	38
Steel 10mm	ml	38
Ring beam	ml	32
Concrete	m ³	1
Steel 10mm	ml	152
Steel 6mm	ml	76
Floor		
Hardcore fill 15cm thick including compaction	m ²	8
Concrete slab 15cm thick with 50x50cm reinforcement grid of 10T bar.	m ²	52
Concrete	m ³	8
Steel 10mm	ml	201
Masonry		
Precast concrete hollow blocks (18W x 39L x 20H cm) with compressive strength at 28 days 1500psi; bedded in cement and sand mortar mix 1:3	m ²	22

columns 19x19x90cm with reinforced concrete mix 1:2:3; including basic and plain finish formwork	pc	10
Concrete	m ³	0.5
Steel 10mm	ml	76
Steel 8mm	ml	10
Steel 6mm	ml	60
Sill beam 18x10cm with reinforced concrete mix 1:2:3; with 12mm connection bars casted inside, 25cm long each	ml	30
Concrete	m ³	6
Steel 8mm	ml	98
Steel 6mm	ml	21
Threaded rod, 12mm, galvanized	ml	15
Bolt & washer, 12mm, galvanized	pc	120
Walls		
Wall: wooden structure made with pressure impregnation treated wood, braced all together	m ²	45
Sill plate: 100 x 50 x 4880mm	ml	32
Top plate: 100 x 50 x 4880mm	ml	64
Mid rail: 100 x 50 x 4880mm	ml	32
Post: 100 x 50 x 4880mm	ml	56
Bracing: 100 x 25 x 4880mm	ml	16
External cladding done with plywood above the window	m ²	18
Plywood 1220 x 2438 x 13mm	pc	12

Openings		
Window: 95x130cm frame with pressure impregnation treated wood, fixed using 4 no. MS clamp	pc	22
Frame: 100x50x4880mm	no.	100
MS clamp 4 nos	pc	
Window shutter: made of locally available best quality palm leaves or other suitable materials.	m ²	27
palm leaves	m ²	27
Door: 185x130cm frame with pressure impregnation treated wood.	pc	2
Frame: 100x50x4880mm	ml	13
Roofing		
Roof: wooden structure made with pressure impregnation treated wood, braced all together, composed of 5 trussed rafter and 4 intermediate rafter, with vented raised ridge	m ²	74
Trussed rafter: 100x50x877mm	no.	80
Intermediate rafter: 100x50x4880mm	no.	30
Intermediate rafter:100x25x4880mm	no.	8
Bracing top wall: 100x25x4880mm	no.	8
Bracing post-trusses: 100x25x4880mm	no.	10
Cross bracing: 100x25x4880mm	no.	24
Gutter plate: 150x25x4880mm	no.	24
End plate: 50x50x4880mm	no.	13
Purlin: 50x50x4880mm	no.	161
Ridge rafter: 50x50x4880mm	no.	9
Gusset plate: Plywood 1220x2438x13mm	no.	5
Gable end	m ²	11
Timber horizontal shutter: 100x50x4880mm	no.	53
Roof sheeting	m ²	87

Corrugated sheet 915x1830mm - SWG 28	no.	74
Ridge cap 120x60mm7 - SWG 28	no.	13
J hooks 3mm dia with bituminous gasket, nut & washer	no.	54
Strapping	L.S	1
4x0.5cm galvanized hurricane straps with rubber gaskets over Corrugated Sheet	no.	72
Galvanized hurricane straps - purlin to rafter	no.	180
Galvanized hurricane straps - rafter to top plate	no.	18
Painting		
Waterproofed painting over the sill beam	m	30
Waterproof paint	gallon	1

Field Notes:

This is space for individual field notes, documentations and observations.



Photo: UNICEF, Pakistan

External view of Transitional school in Roh

PAKISTAN

2010 / Flood / UNICEF 2

Agency:	UNICEF/flood affected areas of Pakistan
Location:	Temporary Learning Spaces (TLS) in Flood Affected Areas, Transitional School Structures (TSS) in Singh province
No. of users:	4,000 TLS: 200,000 children, including 50% girls 200 TTS: 24,000 children, including 10,500 girls Classroom 40sqm with 40 children
Anticipated lifespan:	30 years
Actual lifespan:	not known yet
Facilities provided:	TSS: 3 classrooms per TSS, child-friendly school furniture;

No. of facilities:

Water, Sanitation and Hygiene (WASH) facilities including 4 gender separate latrines, a hand pump and hand washing facility;

External playground equipment; accessibility for special needs children by ramps and specially adapted latrines

Total planned TSS: 500@3 classrooms, 4 latrines

Actual under construction to date: 100 TSS

Construction time:

30 days

Main construction materials:

65% of the school is pre-fabricated insulated steel wall panels on steel substructure, 35% is in-situ brick and mortar work done on the school sites

Material sources:

Produced by local manufacturers and installed by local contractors

Approx. Project cost per unit:

35.000 USD

Approx. material cost per unit:

30.000 USD

Size of units:

Classroom: 8.25m x 4.85m wide, 40sqm

Size of construction team:

Monitoring: 2 internationals, 15 national staff (professional engineers and support staff) for overall earthquake and flood project

Construction: Contractor depending

Construction skill required:

Skilled and non-skilled workers for ground works and fabricators/installers for steel structure components.

Who built the facilities:

Local contractors and suppliers

Site information:

A complete assessment/feasibility was carried to assess if the proposed construction sites are technically, socially, environmentally and financially appropriate. Technical issues: local hazards of not falling into water catchments area, height of water table, landslides risks, electric power lines, geotechnical/topographic conditions. Legal issues: land documents, government ownership, community agreement, security situation

Background

The 2010 Pakistan floods began in late July 2010, resulting from heavy monsoon rains in the Khyber Pakhtunkhwa, Sindh, Punjab and Balochistan regions of Pakistan and affected the Indus River basin. The floods were the worst in Pakistan's recorded history, affecting nearly 20 million people, over half of which were children. According to World Bank estimates, the floods caused damage worth USD9.7 billion, with about 1.9 million homes damaged and key social services – including water, sanitation, health care, and education – all suffered serious damage and will take years to restore. With about 10,000 schools damaged by the floods, and displacement affecting students and teachers, the education system came under severe strain. School enrolment and completion are likely to fail, especially for girls, as families keep their children at home due to economic reasons. Existing girls' enrolment is low due to low education of parents, poverty, lack of women teachers and inadequate sanitation facilities at schools.

Project Description

The purpose of this project was to establish 4,000 Temporary Learning Centres (TLC) at school sites where flood damage had occurred to ensure that approximately 200,000 children, including 50% girls, have continued access to education. In addition, the aim was to establish and furnish 200 Transitional School Structures (TSS) in the Sindh province with gender-segregated WASH facilities, child-friendly furniture and playground material at places of origin of fully damaged schools to secure access to quality education for 24,000 children, including 10,500 girls.

This project was part of an integrated response package incorporating several activities that were developed for each target province. UNICEF Education Section collaborated with the WASH, Health, Child Protection to deliver an integrated package of interventions to ensure that schools provide a protective environment, where children have access to safe water, improved sanitation, health screening and care, psychosocial care, recreation and school feeding.

Sindh experiences prevailing education crises, where vulnerable children are not able to access their right to education. Through the implementation of TSSs many children were able to discover education for the first time. Thereby, the TSS project closes a gap in children's education and provides them with some semblance of normality during the trying time.

In addition to the 'hardware' components of TSS, 'software' components were provided to ensure a complete educational package. This included Health and Hygiene Education Sessions for teachers and students, operation and maintenance training including dismantling and assembling of the TSS for school management committee (SMC) members and Education Works department staff, a set of tools to enable SMCs to undertake minor repairs and maintenance of the TSS, introducing early childhood education classes, promoting community participation through youth groups, teacher training on pedagogy, psychosocial support, child friendly teaching methods and disaster risk reduction (DRR), health screening of students through school health and nutrition supervisors and assorted school supplies including school-in-a-box, recreation and early childhood development kits, and supplies such as fire extinguishers, spades, ropes and megaphones.

A key component of the implementation strategy was the strengthening of community-based mechanisms such as the School Management Committees (SMC). SMCs were reactivated and their capacity strengthened to promote sustainability, security and ownership of education services in their communities. The project was implemented in close collaboration with provincial and district education departments. The assessments of the affected schools were carried out by partners and district education officers. A clear monitoring process for the construction was set up on three levels,

monitored by UNICEF staff, the Executive District Officers (EDOs) and the provincial level education officers as well as the signed certificate of satisfactory completion by the head teachers.

TLS Summary

The TSS package consists of a structure with three classrooms built on high ground and raised 90cm in order to stay above flood levels in flood prone areas. Each classroom is 40sqm accommodating 40 children per class. The walls and roof are made from insulated sandwiched pre-painted metal panels with thermo foam insulation between panels. This protects the inside spaces against heat and cold (a five to ten degree Celsius reduction of heat is observed using the insulated metal panels). Linear ventilation on both sides of upper walls is provided and opening windows are protected by light metal grills. The classrooms are equipped with child-friendly school furniture. External play and activity spaces are equipped with playground equipment. Water Sanitation and Hygiene (WASH) facilities including four latrines separate for boys and girls, a hand pump and hand washing facility are located for secure access and the TSS is made accessible for children with special needs by ramps and specially adapted latrines.

The key design concept for the TSS is that it has been designed and made of collapsible walls joined together by bolts, which allows for them to be dismantled and moved to another location, in case sufficient warning time is available before a disaster strikes. Thus, this makes the UNICEF TSS model unique in that it meets the requirements of DRR and emergency preparedness especially in flood prone areas. UNICEF has developed a training module and trains officials of Education Works Department in the various districts on the optional dismantling and re-erecting of these structures. With this, resumption of schools after an emergency can be done in the shortest possible time. If local authorities choose to leave the TSS in place, it can serve as classrooms for up to 30 years.

A total of 65% of the school is pre-fabricated while 35% is brick and mortar work done on the school sites. Quality control is closely controlled in the factories and shipped in knock down components to the school sites. The TSS is manufactured, constructed and delivered in 30 days after handing over the school site to the manufacturer contractor. Site work is guaranteed through close supervision by UNICEF appointed engineers.

While brick and mortar constructions require a lengthy negotiation process over land ownership, each TSS can be established within a month. UNICEF has the Government of Pakistan's permission to establish TSSs on existing damaged school sites across the flood-affected districts. The TSS facilitated children to continue their education with minimal disruption to the school year while longer-term constructions are in discussion.

Maintenance

For all construction projects a six to 12 month defects liability period is included within the construction contract. The individual contractor is held responsible for any defects during this period and retention amount is kept to rectify defects.

Improvements

- UNICEF Construction unit introduced a hand pump with dual option to pump water to an overhead tank 20 feet high, so that no electric power is needed to run free water to wash rooms.
- Consideration to simplification of access ramps to allow a covered walkway



Photo: UNICEF, Pakistan

Construction of concrete ring beam



Internal view of child-friendly classroom furniture



Photo: UNICEF, Pakistan



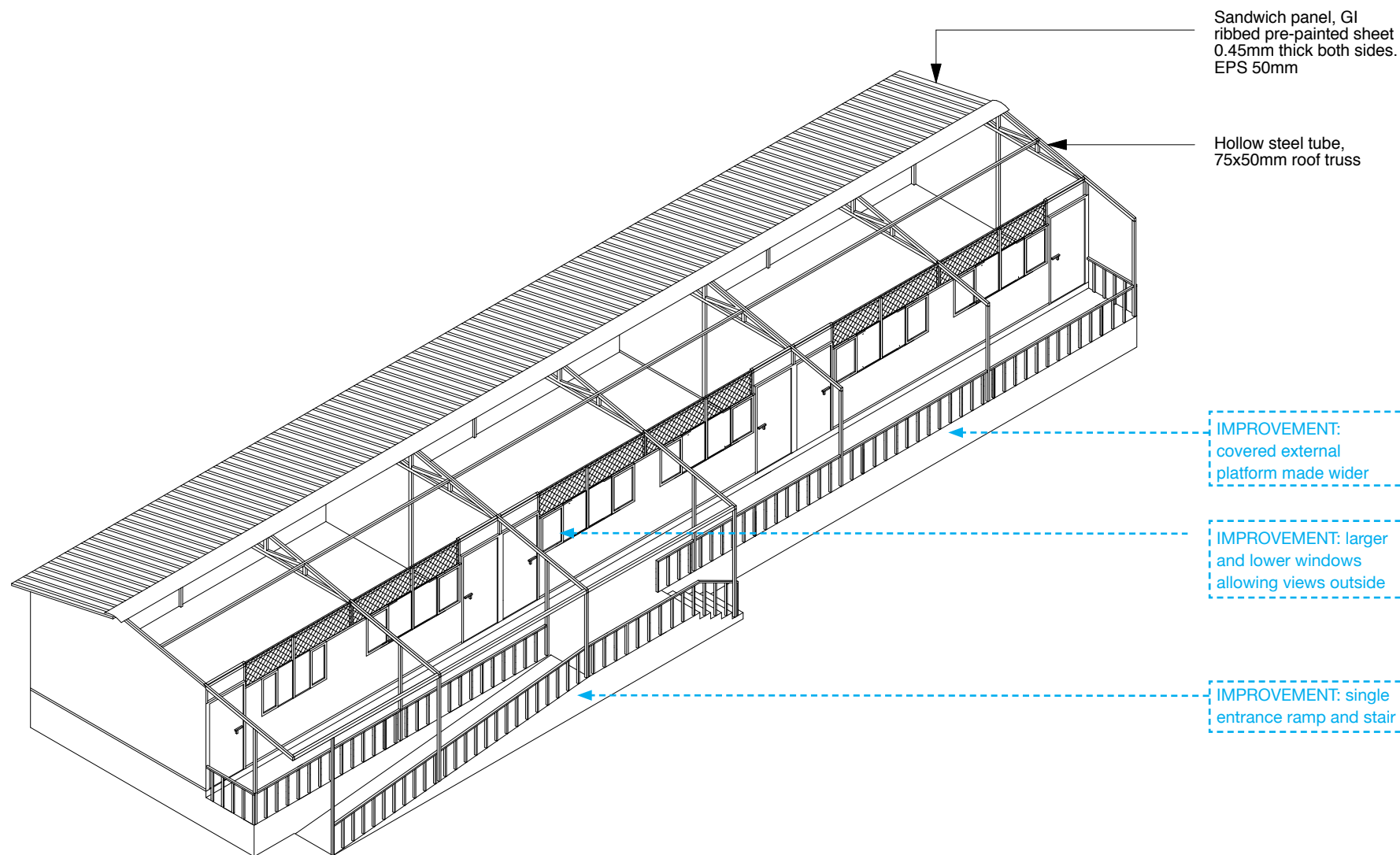
Photo: UNICEF, Pakistan

Classroom tent in disrepair

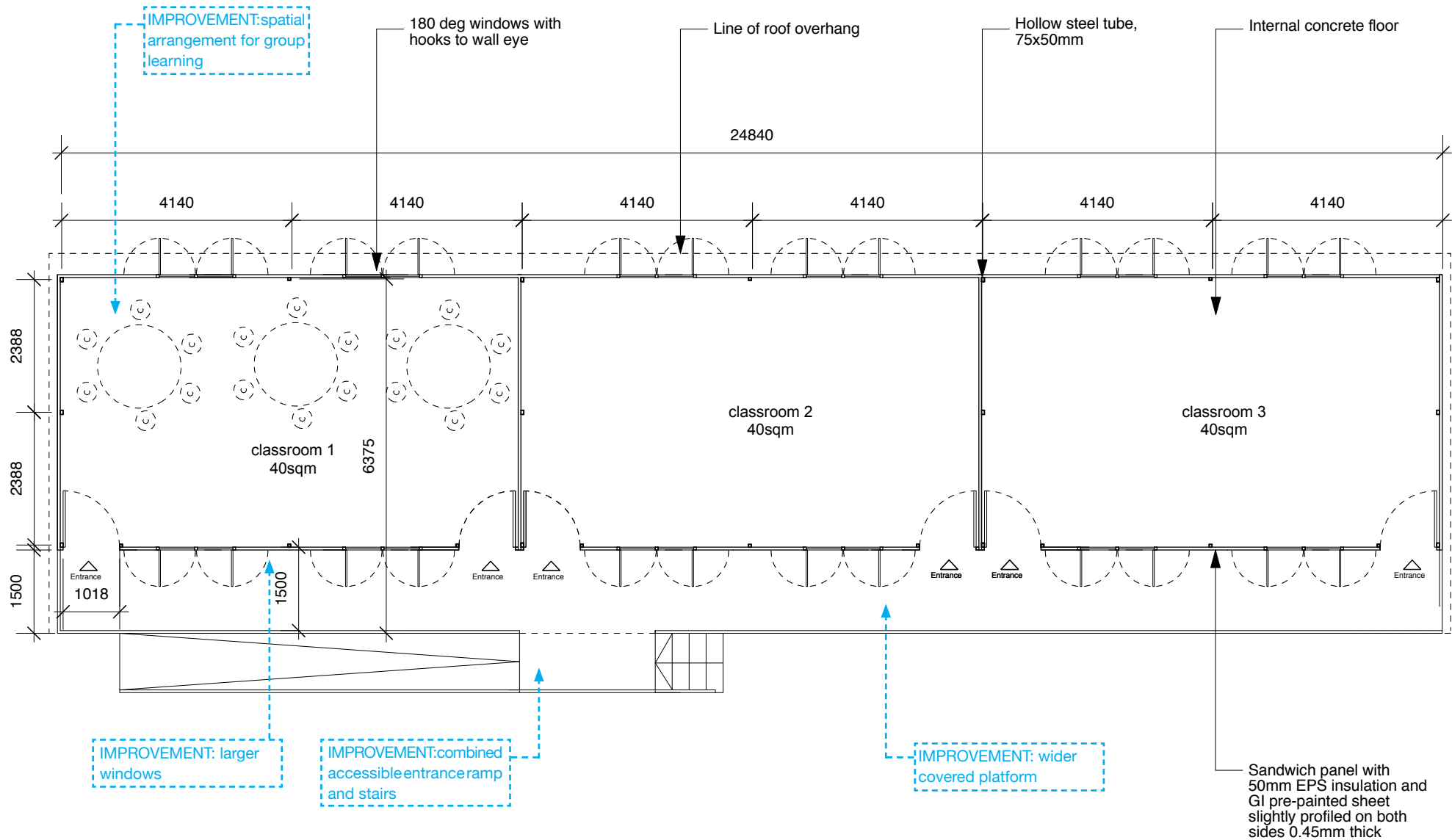


Photo: UNICEF, Pakistan

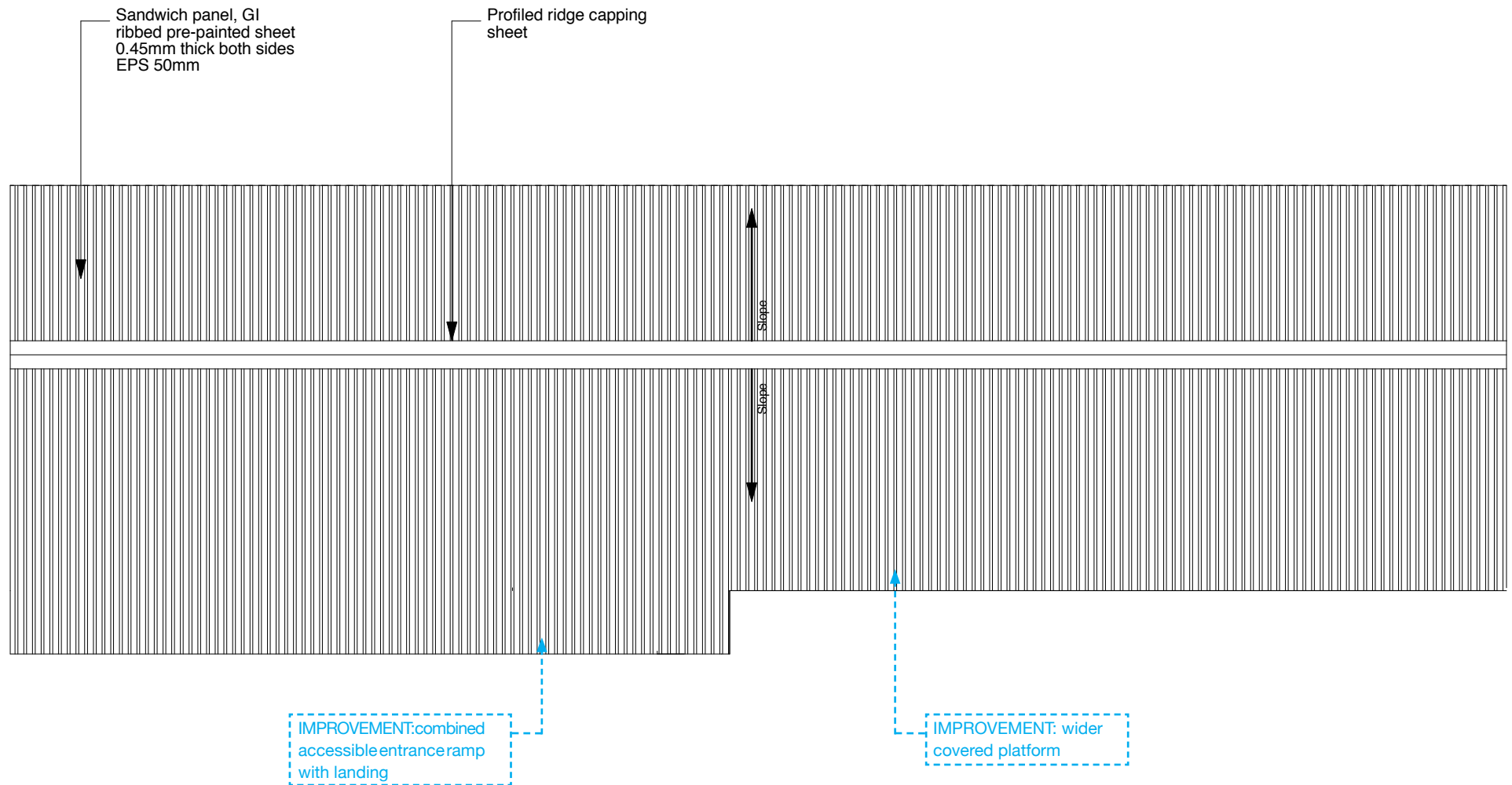
Assembly process of prefabricated wall elements



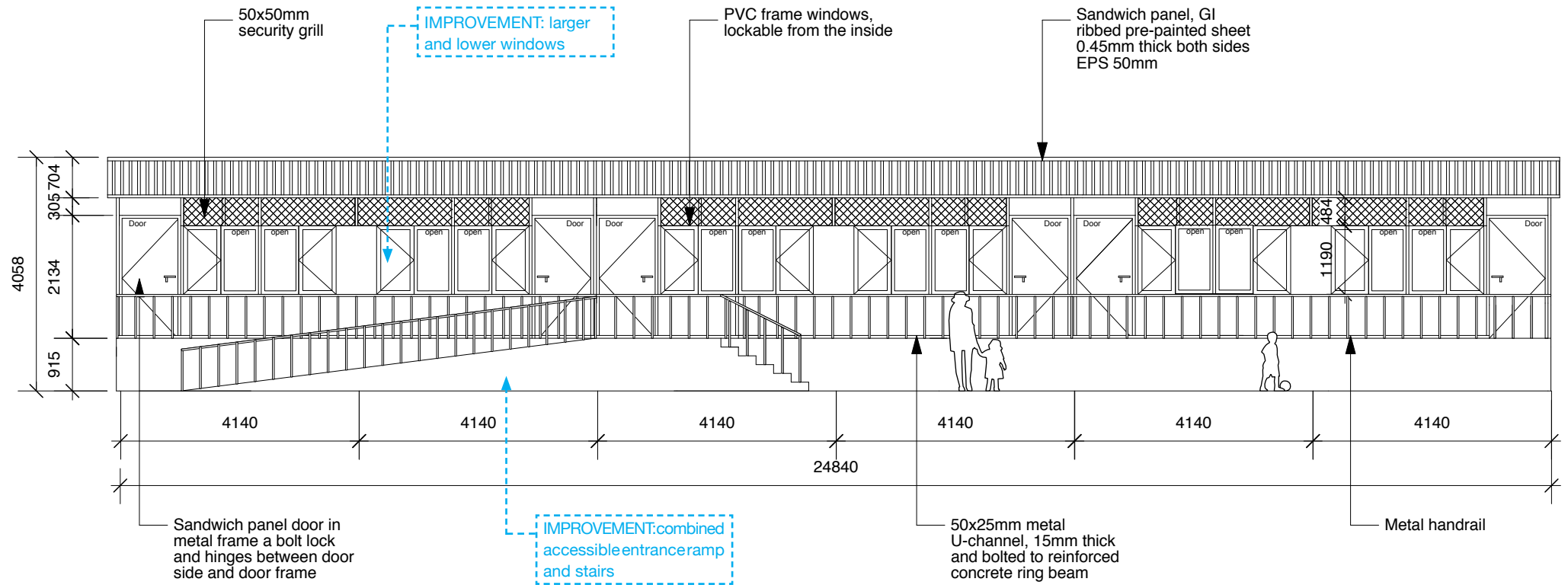
Note: drawing not to scale, for illustrative purpose only



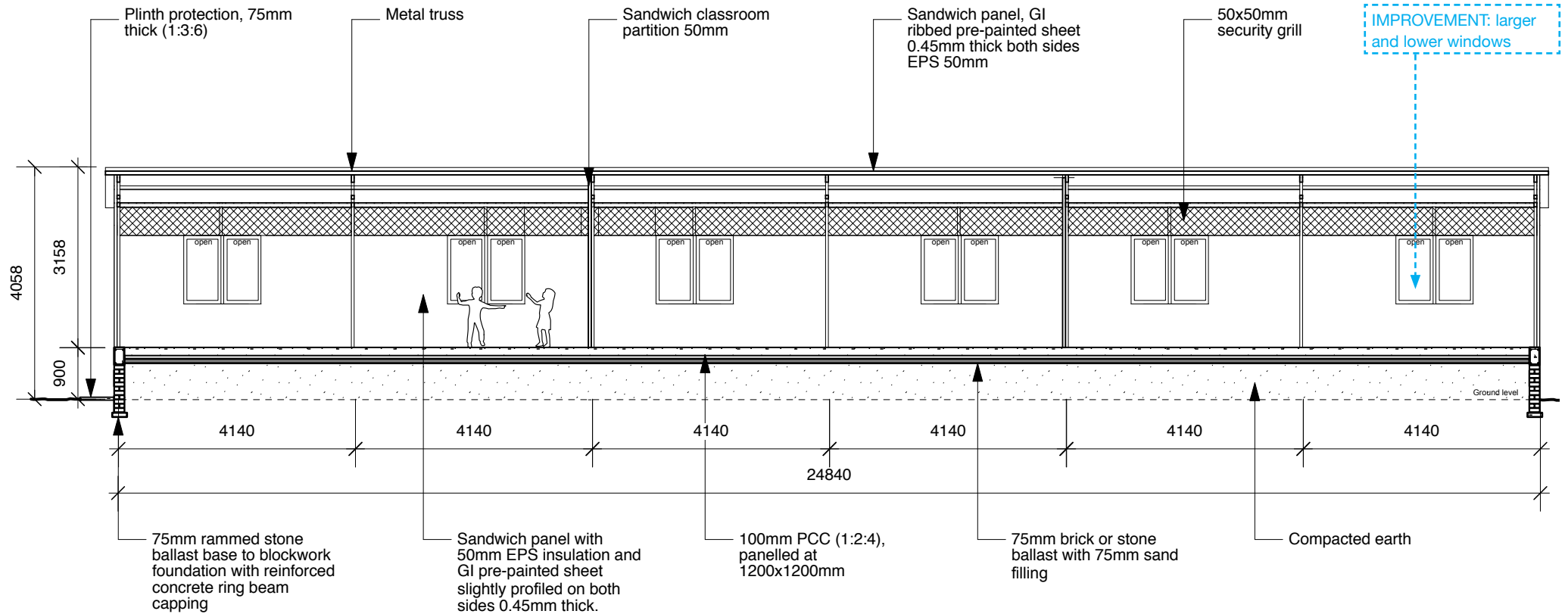
Scale 1:100



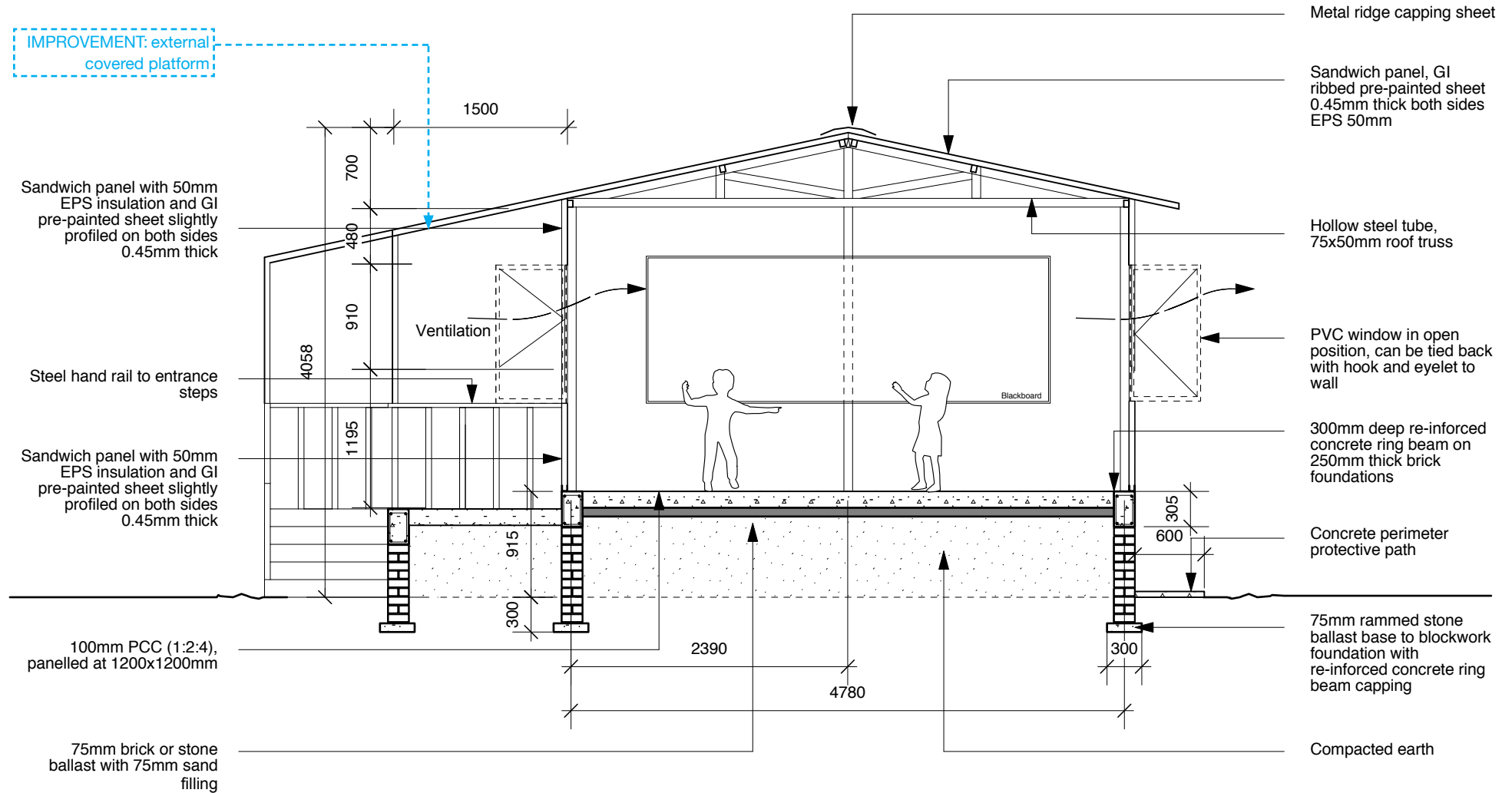
Scale 1:100



Scale 1:100



Scale 1:100



Scale 1:50

Quantities for 3 unit, each 40sqm		
Elements	Unit	Quantity
Foundations		
Cutting, filling, levelling and proper compaction of natural ground	m ²	130
Concrete plinth, PCC 1:3:6, (225x 600mm) , with hooks for anchoring the super structure, for stability against wind	m ³	18
Providing and lying of stone bed 75mm in thickness as base	m ³	9
PCC 1:4: 8 ; 2 inch thick bed as base coat over stone masonry	m ²	1
Concrete surfacing / flooring with PCC 1:2:4, 1 inch thick	m ²	1
Openings		
Doors, 2 no (3ft x 7ft) , providing & fixing	pcs	6
Windows, 3 no per shelter, (3ft x 3ft), supply & fixing	pcs	12
Transparent plastic & mesh for windows	m ²	40
Roof		
Supply of CGI sheets for roof covering, 26 gauge minimum	sqm	160
PGL for sealing top joints, (Locally called Goola), 60 feet x 1 foot	m	62
Walls and ceiling		
Supply of CGI / PGI, 10 feet height for walls	sqm	150
Lassani sheets for friendly wall finishing and ceiling/insulation	sqm	230
Supply of GI box pipe for frame-work, trusses in super structure, (2" x 1.5") & (1.5" x 1.5") sizes, 18 gauge	m	140
Construction of frame, cutting / fixing the size (40 sq-m, 430 sft)	sqm	40
Thermopore for insulation between CGI & Lasani and in ceiling, 1" thick	sqm	230

Fixing of Lassani sheets carpentry wok internal walls & ceiling	sqm	230
Others		
Paint (ICI) for CGI sheet (lump sum)		1
Transportation cost of Material/CGI /sand		1
Screws, nut bolts, hinges, handles, etc		1
Sign board		1
Electricity (lump sum) with 2 fans & 4 light points (optional)		1
Boundary wall with box- pipe & chicken-mesh structure		1

Section D

Innovative Practices

Section D documents a collection of innovative ideas for TLS in emergency situations and innovative technical solutions that have been developed. Some of the innovations have not yet been implemented and tested within a large scale emergency response. However, they offer inspiration and innovative practices that may be included in future TLS projects.



Photo: Education in a box

Education in a Box shipment container during transport

EDUCATION IN A BOX

Container School

Agency:	Education for All
Location:	-
No. of users:	User capacity per one container: Classrooms: 200 children, library 20 children, sport class: 20 children
Anticipated lifespan:	Budget tents: 5 years, the premium tents: 10 years, shipping container (office and library) can be significantly longer if anti-corrosive painted in later years
Actual lifespan:	-
Facilities provided:	Office /library inside container, classrooms
No. of facilities:	A standard Education in a Box consisting of five 6 x 6m tents
Construction time:	1 day after arrival

Main construction materials:	Tents and shipment container
Material sources:	Imported
Aprox.projectcostper unit:	Typical budget level of £15,000, premium level £35,000; cost can vary significantly depending upon the components required.
Aprox.materialcostper unit:	-
Size of units:	Classroom: 6m x 6m wide, 36sqm
Size of construction team:	Tents can be erected by 3 people in 1 day, set up 1 office and library , 15 people to set up whole school; includes construction manual
Construction skill required:	Not required
Who built the facilities:	-
Site information:	-

Background

Around the world children suffer when their education is severely disrupted through natural disasters, conflict and population displacement. Education for All has developed an educational environment contained within a standard sized shipping container. This 'Education in a Box' is equipped with tents, desks, chairs, teaching aids, stationary and a library or office suit that can be built to the requirements of its users. The education in a box is designed specifically for emergency response and displaced populations.

Project description

A standard Education in a Box consisting of five 6x6m tents and one shipment container for office or library use. Its key characteristic is that it is based around a standard 20' shipping container. All components are packed within this standard transportable system, which removes the need for individual purchase orders for components and possible logistics implications of staggered delivery times.

The Education in a Box container is fitted with shelving around 1/3 of the length and rear of the container walls so forming a library. These library shelves are later filled with books and stationary resources, or they can be changed to create a full office suite. The remainder of the school equipment, (tents, desks, chairs, etc. along with optional extra requested items) is then packed in the container. Furniture for Early Childhood and Development, primary and secondary age pupils is available.

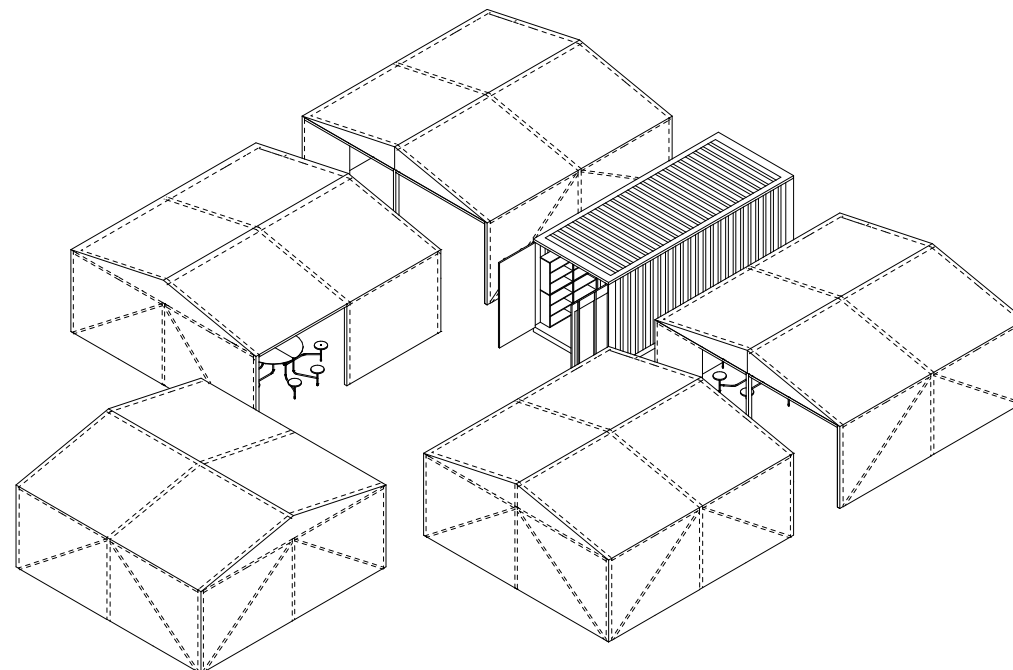
Education for All can be contacted for more information under:
Simon_Devine@educationforall.com

Transportation

The container is despatched from Education for All's UK warehouse within days of request. There are two main worldwide types of haulage chassis designed for the transportation: 23 ½' Straight frame chassis can carry one unit and the 41' straight frame chassis designed to carry two units. Modified flatbed trucks have also been known to carry 20' containers when the need arises.

As there are no perishable goods within the components of the Education in a Box and it is cased within a water tight shipping container, it can be safely and easily stacked and stockpiled at strategic locations, perhaps focusing on watch-list countries, so it can be delivered at very short notice.

When the container arrives at its destination, the tents can be assembled singularly or in multiples depending upon individual requirements and teaching capacity, forming classrooms to hold between 20 and 200 students. The container is fully lockable so all equipment can be safely secured within, both during transportation and if required for daily security.



Facilities available within one container



Photo: Education in a Box, Simon Devine

Internal view of the classrooms showing different styles of table layout available



Photo: Education in a Box, Simon Devine

Play equipment for the Early Childhood and Development module available



Photo: Education in a Box, Simon Devine

Internal view of Education in a Box tent classroom



Photo: Education in a Box, Simon Devine

6x6m tent premium design made of aluminium frame and toughened PVC cover

Quantities for a single box unit		
Elements	Unit	Quantity
Standard kit		
6m "Education in a Box" shipping container	no.	1
Sledge hammer	no.	1
Trolley mounted dry wipe/chalk boards	no.	10
Pack of pins	no.	1
Reams of paper	no.	1
Pack of dry wipe board pens	no.	15
Pencils – Pupils	no.	300
30cm ruler – Pupils	no.	300
Exercise book – Pupils	no.	300
Pencils – Teachers	no.	20
300mm ruler – Teachers	no.	20
Exercise book – Teachers	no.	20
Board wipe – Teachers	no.	15
Colouring pencils (pack of 12) – Teachers	no.	30
1m ruler – Teachers	no.	15
Desks	no.	200
Chairs	no.	200
Library shelving set	no.	1
Filling cabinet	no.	1
Mounted dry wipe boards	no.	1
Mounted pin boards	no.	1
Desk (administration / teachers)	no.	1
Office chair	no.	1
Flip chart	no.	1

Tall cupboard	no.	1
Sports equipment set - 2 x footballs, 2 x netballs, 1 x parachute [inc games book], 10 x cones, 20 x bibs, 1 x bat & ball	no.	1
Storage chest	no.	1
First aid kit	no.	1
Generator	no.	1
Light	no.	1
Extension cable	no.	1
20 litre jerry can + funnel	no.	1
Padlock and chain	no.	1
Tents		
6m x 6m tent – Aluminium structure – premium	no.	5
6m x 3m tent – Steel pole structure – budget	no.	10



Image: Carlos Vasquez, UNICEF

PAKISTAN

Proposed TLC

Project description

This case study documents a design for a proposed child-friendly transitional learning centre for the flood-affected areas of Pakistan. The child-friendly schools architect Carlos Vasquez, from UNICEF NY, made the proposal.

Particular care was placed on including key child-friendly school components within a transitional learning environment. The school is comprised of three classrooms, a covered external activity space, teachers' space, gender separated latrines with hand wash basins, drinking water point, external play space and a boundary wall.

The internal classrooms have sufficient natural lighting from two sides allowing ventilation and visibility into and out of the spaces. A covered walkway connects the classrooms and provides weather protected external activity space for the children in front of the classrooms. The walkway extends to the latrines, which are located in a distance that still allows good visual supervision of the latrine entrances. The latrines are separated into boys and girls areas with extra space within the girls' area to allow privacy. A drinking water point with sealed concrete flooring is located nearby. The classrooms are arranged to naturally create a courtyard enclosure around the external play and activity space. The whole school is protected by a boundary fence for protection and supervision.

A key design concept of this proposed transitional learning environment is to only use local materials and construction skills. Furthermore, it allows the school to be built within a reasonable time frame of eight weeks to a reasonable cost of approximately USD 11,100 (2010). A very important element is that the cost for this school was established by the local government's construction unit with detailed bills of quality and scope of work.

The construction material selection is based on locally available, affordable and culturally as well as climatic appropriate materials. The walls are made from compressed earth blocks with window openings and a bamboo roof construction. The raised walkways and flooring are constructed from compacted gravel with a concrete finish.

The classrooms as well as the other facilities are accessible by a ramp to allow access for children with disabilities. To protect the school from future flooding while it is in use it is raised off the ground by three steps.



Image: Carlos Vasquez, UNICEF

Area photo



3-D Illustration: Gaston Becerra

External view of covered walkway and classroom

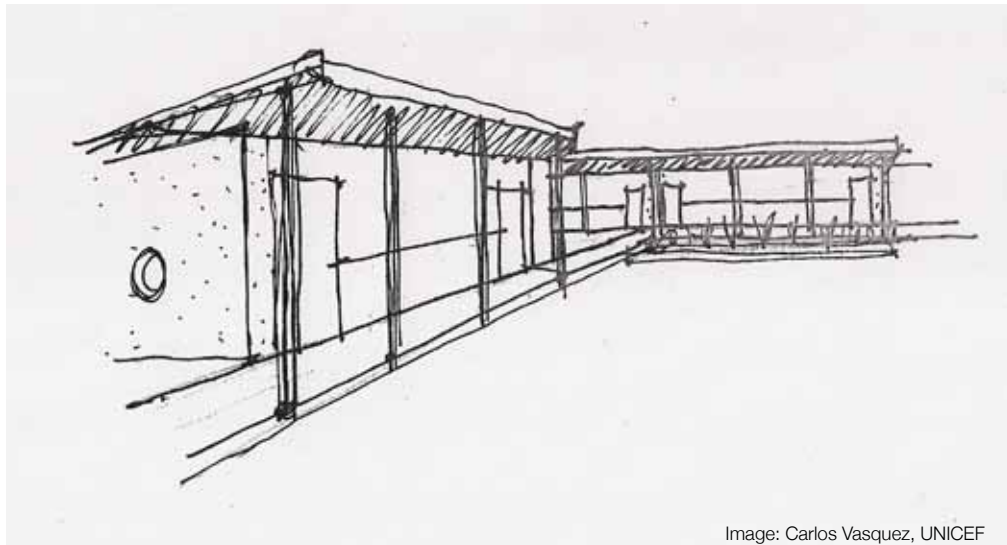


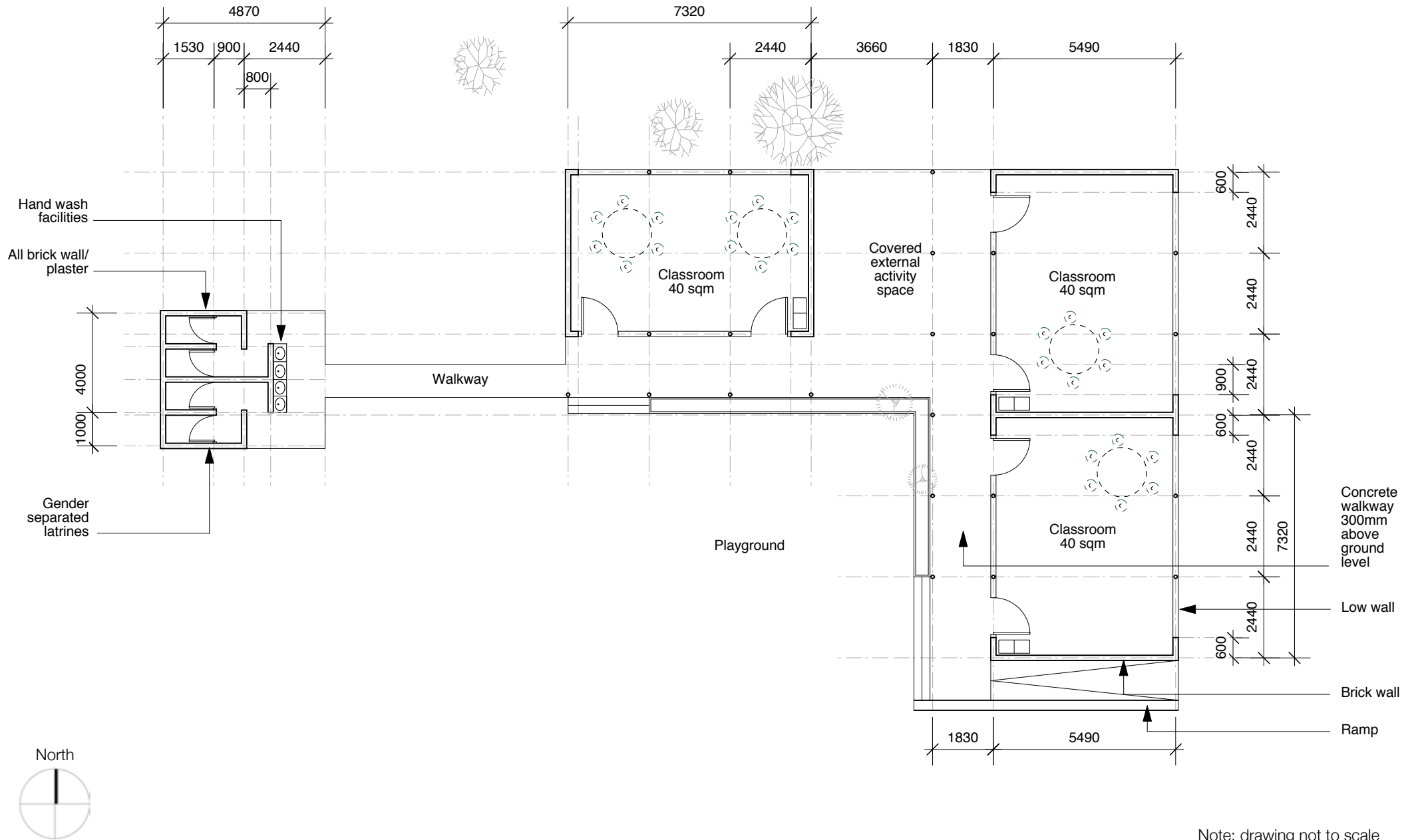
Image: Carlos Vasquez, UNICEF

Architectural sketch of external view and playspace

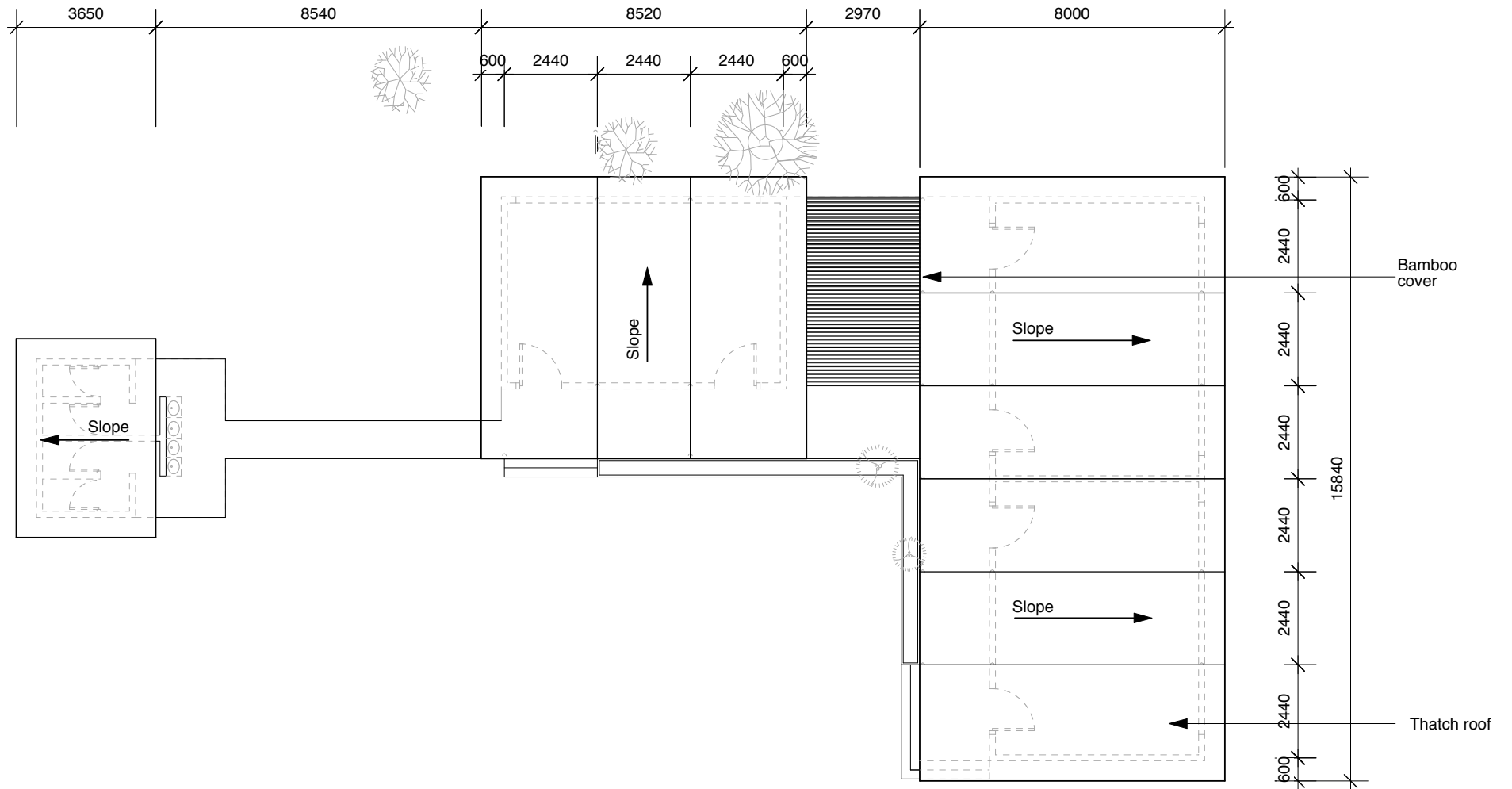


3-D Illustration: Gaston Becerra

External view of covered walkway and classroom with indicated shaded areas



Note: drawing not to scale



Note: drawing not to scale

Detailed estimate for construction of a bamboo roofed school in flood affected area**by District Building Division, Multan, Pakistan, 2010****GENERAL ABSTRACT OF COST**

1. Construction of 3 Nos Class Room 24x18" with 8' verandah	6,633 USD
2. Toilet Block	1,398 USD
3. Boundary wall 300 Rft @ 8.14 USD	2,440 USD
4. Construction of gate & gate pillars	686 USD
Total construction cost	11,158 USD

3 no. classrooms: (24'x18')

Elements	Unit	Quantity	Cost
Excavation in foundation of buildings bridges and other structure	Cft.	1023	32 USD
P/L watering ramming brick ballast 1-1/2" to 2" gauge in foundation	Cft.	280	73 USD
Pacca brick work 1:6 cement sand mortar	Cft.	884	937 USD
DPC of cement concrete (1:2:4) 1-1/2" thick with one coat of bitumen and one layer of polythene sheet, 300 gauge	Sft.	194	64 USD
Filling, watering, ramming earth under floor with surplus earth from foundation	Sft.	682	10 USD
Pacca brick work in 1:6 cement sand mortar	Cft.	2091	2362 USD

Elements	Unit	Quantity	Cost
Dry brick ballast 1-1/2" to 2" gauge	Cft.	422	109 USD
Topping of cement concrete 1:2:4, finishing complete	Sft.	1726	442 USD
Precast girder 4"x 9" of approved firm	Rft.	95	109 USD
Fabrication of heavy steel	Kgs	779	839 USD
Bamboo cane	Rft.	2052	355 USD
Sirkanda patal (thatches) with finish sirkanda	Sft.	1945	134 USD
Polythene sheet, 500 gauge	Sft.	1945	46 USD
3" thick earth laid on roof, 1" thick mud plaster with gobri leaping	Sft.	1945	147 USD
Cement pointing flush 1:3 cement sand mortar	Sft.	1869	191 USD
1/2" thick cement plaster 1:5	Sft.	3100	332 USD
Making of notice board made of c/s mortar 1:3	Sft.	72	36 USD
Dry wood door, iron hinges, anti termite coating and painting complete	Sft.	140	242 USD
Sirkee sirkanda (Chiks) with cloth covering, patti cloth window	Sft.	410	80 USD
White washing 3 coats	Sft.	2870	45 USD



Photo: solarlighting-s.com/solar-bottle-bulb/

WATER BOTTLE LIGHT

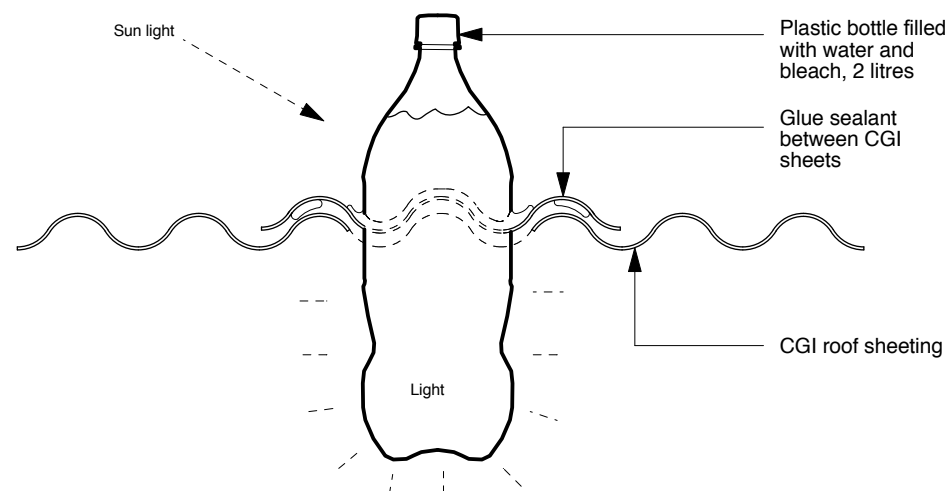
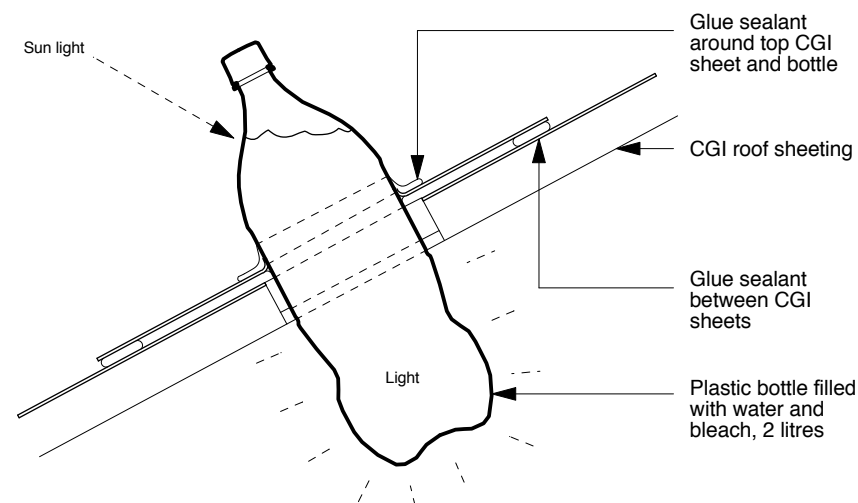
The water bottle light is a simple and innovative idea to bring natural light to dark and unlit spaces that do not have connection to electricity, for example existing classrooms. It could also further increase the even spread of natural lighting throughout the TLS.

The water bottle light is a plastic bottle filled with water and inserted into the roof sheeting. The water filled recycled empty polyethylene terephthalate (PET) bottles is filled with water and a drop of bleach, to prevent algae, creating a metal collar and inserted into the roof. The light can provide as much daytime light as a 60 watt bulb at a cost of about one US dollar each. The water-filled bottle refracts the sunlight. This lighting solution has been used by the Solar Bottle Project, Isang Litrong Liwanag (A Liter of Light) organisation. It has installed 10,000 Solar Bottle Bulbs throughout Manila.

Reference and further information: www.solarlighting-s.com/solar-bottle-bulb/

How to Make a Solar Bottle Bulb:

- Fill plastic bottles with water and bleach then capped; bleach works to make the water clear and also to prevent fungus or microbe.
- Make holes in the metal roofs, insert the bottle **and then sealed to avoid leaks when it rains.**
- Plastic bottles refract sun light and pushed into every corner of the home rather than to high-light one area like an ordinary lamp.
- Simple technology that can be installed in less than an hour, lasting for five years, and equivalent with 60-watt light bulb.



Scale 1:5



SOLAR LIGHT

This solar products harness the power of the sun to fulfill the three main energy needs of off-grid consumers: lighting, connectivity, and information. The product comes in a modular version including solar panel, LED rechargeable lamp, rechargeable battery pack, mobile phone connectors and radio connectors. It can be used for lighting, recharging of mobile phones and to power radios and computer. The solar LED light components are very robust and have four intensity settings and provides up to 40 hours of light. The lamp can be hung or carried around as it is very light. The cost for a solar light kit is approximately \$35.

Reference and further information: www.toughstuffonline.com



CERAMIC WATER FILTER

The ceramic water filters (CWF), developed by Potters for Peace, is a simple, bucket-shaped clay vessel that is made from a mix (by weight) of local terra-cotta clay and sawdust or other combustibles, such as rice husks. The filters are formed by using a press. When in use, the fired and treated filter is placed in a five-gallon plastic or ceramic receptacle with a lid and faucet. Water passes through the clay filter element at the rate of 1.5 to 2.5 liters per hour.

The ceramic filter aims to meet the urgent demand for safe water. It is a technology that can easily be copied by local workshops. Pricing for ready-to-use filter units, including the receptacle, is determined by local production costs and is usually between \$15 to \$25. Replacement clay filters will cost \$4 to \$6. A basic production facility with three or four workers can produce about fifty filters a day.

In an effort to share and develop CWF technology on a global scale, PFP's ongoing development of the CWF uses the Open Source manufacturing model. No patent is held on the CWF and the technology is available to anyone.

Reference and further information: www.pottersforpeace.org



RECYCLED BLOCK

The 'rebirth brick', is a light weight construction block made from debris materials. The low cost block making technology was invented by the Chinese architect Liu Jiakun in response to the vast destruction after the Sichuan earthquake and is used for construction in the rural earthquake affected areas.

The debris from the destroyed buildings is collected, sterilized and crushed to become aggregate for the new block. It is mixed with wheat branches that are cut into small pieces as reinforcing fiber. The aggregate mixture is stabilized with concrete and compacted in a semi-manual leverage tool which is widely used in China by the local crafting industry.

Reference and further information: www.jiakun.com/Project.aspx?nid=495



BANANA LEAF SANITARY PADS

Sustainable Health Enterprises (SHE) works in Rwanda with their she28 campaign and has developed an affordable and eco-friendly sanitary pad made from banana stem fibres to allow girls and women to attend school and work unimpeded by worries over their menstrual cycle. In many cases, girls and women do not have access to affordable sanitary pads, and social taboos against discussing menstruation compound the problem leading to large numbers of girls and women missing school and work. Consequently, this can lead to a disruption in their education and employment opportunities with significant costs in terms of education, economics, health, and dignity for girls and women.

Reference and further information: www.she28.sheinnovates.com

Further reading:

- **Child-Friendly School Manual**, UNICEF, 2009
- **Education in Emergency**- a resource tool kit, UNICEF, 2006
- **Education in Emergency: Including Everyone, Pocket guide to inclusive education**, INEE, 2009
- **Guidance Notes on Safer School Construction**-Global Facility for Disaster Reduction and Recovery, GFDR et al , 2009
- **Guidebook for Planning Education in Emergencies and Reconstruction**, 2nd edition International Institute for Educational Planning, UNESCO, 2010
- **International Building Code (IBC)**, ICC (International Codes Council), 2009
- **Minimum Standards for Education: Preparedness, Response, Recovery** ,2nd edition, Inter-agency Network for Education in Emergencies, INEE, 2010
- **Plastic sheeting**, a guide to the use and procurement of plastic sheeting in humanitarian relief, Oxfam, IFRC, 2007
- **Pocket Guide to Supporting Learners with Disabilities**, INEE, 2010
- **Schools for All** –including disabled children in education, Save the Children, 2002
- **SPHERE PROJECT**, Humanitarian Charter and Minimum Standards in Humanitarian Response, Third edition, 2011
- **Teaching children with disabilities**, UNESO, 2009
- **WASH in schools**, raising clean hands, UNICEF, 2010
- **WASH compendium**, UNICEF, 2011, www.unicef.org/wash/schools

Assessment tools:

- **Child led disaster risk reduction**
www.preventionweb.net/english/professional/trainings_events/edumaterials
 - Introducing ways of getting children to be aware of DRR and specific risks to their community

- **Disaster prevention for schools guidance for education sector decision makers** (2008)
www.preventionweb.net/english/professional/publications/v.php?id=7556
 - Document that contains some simple questions teachers and students can use to assess their school with some case studies (p 6-8)
- **Disaster risk reduction begins at school**,
www.unisdr.org/eng/public_aware/world_camp/2006-2007/good_practices_en.htm
 - Case studies of introducing DRR awareness into schools
- **Effective education for DRR teachers network**
www.edu4drr.org/page/drillsplans-1
 - Exercises and plans to help teachers bring awareness of natural disasters into the curriculum but focus more on emergency drills and response etc. includes complete teachers guide
- **Rapid Visual screening of buildings for potential seismic hazards**
www.fema.gov/library/viewRecord.do?id=3556
 - The target audiences for this guide are building officials, engineers, architects, building owners, emergency managers, and interested citizens
- **School Environmental Assessment Tool, SEAT, 2010**
www.humanitarianschools.org
 - Assessment template for school community to self-assess the current condition of their school environment
- **Tools for community assessment and risk planning**
www.proventionconsortium.org/?pageid=32&projectid=8
 - Database with links to many documents and assessment toolkits for community use across the world and includes a complete teachers guide

